

# AutoZone®

## Tool & Equipment QUARTERLY

Call 901-300-4878



**FREE SHIPPING**  
WITH MOST ORDERS  
SEE PAGE 2 FOR DETAILS

**2026**  
APR-JUN



**ROBINAIR**

**Premier 1234yf  
Recovery Machine**

SKU 1212384 | ROBAC1234-4

**6,850<sup>99</sup>**



**MAHLE**

**ACX-2250 Recovery  
Machine for R1234yf**

SKU 213151 | MSSACX2250

**6,299<sup>99</sup>**



**CPS**

**Advanced Dual-Gas  
Refrigerant Recovery Center**

SKU 1407510 | CPSMSX3030

**8,799<sup>99</sup>**



**ECOTECHNICS**

**Eco Dual Gas  
A/C Service Station**

SKU 1335792 | HOFEEAC800

**10,809<sup>99</sup>**

See Pages 14-15 for More Recovery Machines

**OEM TOOLS**

**VT47 TPMS Tool with  
10 TPMS Sensors**

SKU OSB  
OEMVT4710K

**599<sup>99</sup>**

**NEW**



See Pages 103-104 for More TPMS Tools

**NITROUS  
KEYS**

**Triton PLUS Key Machine**

SKU OSB  
NIT20201002

**4,199<sup>99</sup>**

**NEW**



See Page 128 for More Key Machines

Free Delivery in 48 Continental United States • Hablamos Español

SKU 1618375 AZG0226



**DEDICATED TO HELPING YOUR BUSINESS RUN BETTER**



The AutoZone® Tool and Equipment Team is here to ensure our customers are always satisfied. As our customer, you can expect fast, personalized and professional service. Our customer service associates have over 200 years of combined experience in the tool and equipment industry.

**Call AutoZone® Tool & Equipment at 901-300-4878 for Questions Concerning:**

- Equipment Selection
- Product Delivery
- Service After the Sale
- Product Availability
- Technical Support
- Ordering Capital Equipment

**Call Your AutoZone® Commercial Sales Manager or Go to AutoZonePro.com**

- To Place Orders for Parts, Tools and Equipment
- For Questions Related to Parts and Vehicle Accessories
- For Commercial Credit, Lease or Financing Information

Scan This QR Code to Link to the Digital AutoZone Tool & Equipment Catalog on AutoZonePro.com



Section 179 and 100% first-year depreciation may allow immediate write-off of qualified equipment placed in service in 2026. Check with your CPA.

**FREE OVERNIGHT SHIPPING**



Free overnight shipping available to continental U.S. for qualifying orders of 70 lb. or less. Free overnight shipping excludes: liftgate fees, residential delivery, non-network carriers, and certain freight intensive items that are shipped FOB.

**IMPORTANT INFORMATION ABOUT RECEIVING YOUR FREIGHT ORDER**

The freight company will call 24 hours prior to delivery. It is important to take or return their calls to schedule delivery. Most items are shipped freight prepaid. Limited access, residential, carrier surcharges, redelivery and storage fees are not included.

**OFFLOADING? Do you need:**



- Items shipped via flatbed and most lifts will require a forklift.
- Palletized items including most capital equipment and tool storage require a liftgate or forklift.
- Drivers will not allow you to break down pallets and offload by hand.
- Inside delivery is not available. Product will be dropped as close as safely possible. Make sure your location is accessible to the truck and driver.
- DO NOT SIGN until you have inspected the freight and confirmed carton/pallet count.
- Refuse shipment and/or notate any discrepancies or possible hidden damage on the bill of lading.
- DO NOT ACCEPT OR SIGN FOR DAMAGED ITEMS. Accepting and signing for a damaged or short shipment without notation releases the carrier and distributor from any claim or responsibility.
- Contact us at 901-300-4878 immediately with any questions or problems with delivery.
- For hidden minor or cosmetic damage, we may at our discretion, choose to send replacement parts.

**ASK BEFORE YOU RETURN**

Many of the Tool and Equipment products are covered by the manufacturer's warranty and will be serviced and repaired in the field.

**Note: Most manufacturers require you to register your products with them before receiving support or service.**

**IF YOU HAVE QUESTIONS ABOUT WARRANTY OR RETURNS CALL 901-300-4878.**

**AUTOZONE® STORE MANAGERS AND COMMERCIAL SALES MANAGERS**

**Call Your Tool & Equipment Team at 901-300-4878 for Questions Regarding:**

- Product Ordering and Availability
- Assisting Customers with Price Quotes
- Service After the Sale
- Help with Outside Buy/EPO Orders

Prices subject to change without notice. Prices do not include applicable taxes, vehicles, tires, rims, installation or optional equipment as shown. Please do not return purchases to the store. For information regarding warranty, repair, or any questions or concerns, call 901-300-4878.

To place orders or for pricing contact your AutoZone® Commercial Sales Manager.  
For product information, availability and product support, **call 901-300-4878.**

## TOOLS AND EQUIPMENT IN THIS ISSUE:

Advanced Driver Systems (ADAS) . . . 29	Engine Service . . . . . 59-63	Key Machines . . . . . 128	Shop Supplies . . . . . 142-145
Air Compressors . . . . . 74-75	Engine Stands & Cranes . . . 72-73, 117	Lighting & Flashlights . . . . 13, 32-34	Smoke Leak Detectors . . . . 27, 115
Air Conditioning . . . . . 14-24, 115	Evaporative Coolers . . . . . 10-11, 98	Motorcycle Lift . . . . . 4, 95	Specialty Tools . . . . . 52-58, 115, 117
Air Tools & Accessories . . . . . 76-81	Exhaust Tubing Bender . . . . . 127	Oil Change . . . . . 40-43, 117	Surface Prep . . . . . 78, 80
Air Hoses & Reels . . . . . 81	Fans . . . . . 10-11	Paint & Body . . . . . 90, 129	Technician Sets . . . . . 47, 85
Alignment . . . . . 86-90, 97	Fluid Handling . . . . . 44-48, 114	Parts Washers . . . . . 98, 125-126	Thread Repair . . . . . 141
Automotive Lifts . . . . . 90-97, 117	Generators . . . . . 75, 127	Power Tools & Accessories . . . 82-84	Tire Service . . . 90, 94, 98-109, 116
Battery Service . . . . . 9, 35-38	Gloves . . . . . 130, 147	Pressure Washers . . . . . 127	Tool Organization . . . . . 122-123
Brake Lathes . . . . . 110	Grease Guns . . . . . 39	Pullers . . . . . 20, 35, 53, 55, 58-61, 65-68, 114-115, 124, 129	Tool Storage . . . . . 5, 118-121
Brake Service . . . . . 110-114	Hand Tools . . . . . 5-8, 132-140	Ratchets . . . . . 134-135	Torque Wrenches . . . . . 56, 106
Chassis & Suspension . . . . . 64-68	Hardware Kits . . . . . 19, 23-24, 52, 144-145	Regulators, Filters, Drains . . . . 81	TPMS Tools . . . . . 103-104
Cooling System . . . . . 49-51, 115	Heating & Cooling . . . . . 10-13	Rivet Tools . . . . . 57	Tubing . . . . . 80
Creepers & Seats . . . . . 143-144	Heavy Duty . . . . . 115-117	Safety Supplies . . . . . 146-147	Vacuum Pumps . . . . . 16-17
Diagnostics . . . . . 25-31, 62	Inflators . . . . . 104	Scan Tools . . . . . 26, 115	Welding & Cutting . . . . . 130-131
Disconnect Tools . . . . . 52	Jacks & Hydraulics . . . 9, 69-73, 117	Shop Equipment . . . . . 124-128	Wheel Weights . . . . . 108-109
Drill Bits & Extractor Sets . . . . . 141	Jump Starters . . . . . 9, 36	Shop Presses . . . . . 124	Wrenches . . . . . 8, 132

## BRANDS IN THIS ISSUE:

ABAC . . . . . 74-75	CTA . . . . . 42, 59	Livernois . . . . . 63	Robinair . . . . . 15
Access Tools . . . . . 57	Cutting Edge . . . . . 73	Mahle . . . . . 14-15, 48, 51	Rotary . . . . . 87, 92, 99, 116
Aircat . . . . . 76-77	Duralast . . . . . 5-9	Manatec . . . . . 102	SAS . . . . . 146-147
AirSept . . . . . 24, 52	EcoTechnics . . . . . 14-15	Marson . . . . . 57, 62	Shark . . . . . 40, 80, 82, 84, 96, 105, 111, 126
ALLDATA . . . . . 25	EnergyLogic . . . . . 12	Mastercool . . . . . 11, 15-24, 27, 49, 52, 113, 115	Sheffield . . . . . 121, 139
American Forge & Foundry . . . 70-73, 117	FIX-A-THRED . . . . . 62	MaxJax . . . . . 95	Slip-N-Grip . . . . . 142
Arrow Pneumatics . . . . . 81	FJC Inc. . . . . 19	Mi-T-M . . . . . 75, 127	Solar . . . . . 36, 38
Associated . . . . . 35-38	Flexzilla . . . . . 34, 81	Midtronics . . . . . 35	SP Tools . . . . . 34
Astro . . . . . 77, 104	Flo-Dynamics . . . . . 48	Mighty Seven/M7 . . . . . 77	SRI . . . . . 125
ATD Tools . . . . . 129	Forney Industries . . . . . 130-131	Mityvac . . . . . 31, 44-45, 112	Steck . . . . . 54, 57, 72, 143
Atlas Automotive . . . . . 75, 94	Forward Lift . . . . . 89, 92	MotorVac . . . . . 29, 48, 114	Streamlight . . . . . 34
Autel . . . . . 26, 28-29, 38, 104	GearWrench . . . . . 132	Nitrous Keys . . . . . 128	SUNEX . . . . . 79
Balcrank . . . . . 47, 51	GreatLite . . . . . 34	OEMTOOLS . . . . . 10, 16-20, 22-24, 27-28, 32-36, 38-47, 49-73, 76-83, 84-85, 88, 95, 103-104, 106-109, 111-115, 117, 120-127, 129, 131-144, 146	Sunfire . . . . . 12
BendPak . . . . . 73, 86, 89, 93-98, 117, 127	GreatNeck . . . . . 133, 135, 138-140	Phoenix Systems . . . . . 112, 114	SUR&R . . . . . 29, 41-42, 145
Branick . . . . . 65, 107	H&S Autoshot . . . . . 130	Portacool . . . . . 11	Sure Shot . . . . . 114
BRM . . . . . 60, 114, 125	Hardware Machinery . . . 23, 144-145	Power Probe . . . . . 30, 55	Sylvania . . . . . 13
CEMB . . . . . 87, 100, 102	Hofmann . . . . . 86, 88-89, 102	Pro-Cut . . . . . 110	TEXA . . . . . 14, 30, 115
Central Tools . . . . . 56, 106, 111	Homak . . . . . 118-119, 121	QSP . . . . . 65, 88	TMR/The Main Resource . . . . . 105
Challenger Lifts . . . . . 73, 89, 91, 95-96, 117	Ingersoll Rand . . . . . 76-78	Quality Lifts . . . . . 91	TOPDON . . . . . 26, 35-38
Champion Power Equipment . . . 127	Innova . . . . . 31	QuickJack Lifts . . . . . 95	Traxion . . . . . 143
Coats . . . . . 87, 89, 92, 99, 101, 105, 116	IPC . . . . . 126	Ranger . . . . . 47, 71-72, 100, 102, 110, 116, 126	Tuxedo . . . . . 90
Cool Boss . . . . . 11, 98	John Dow . . . . . 46, 52, 142, 145	Rapidair . . . . . 80	UView . . . . . 21-22
CPS . . . . . 15, 17, 23, 115	Ken-Tool . . . . . 127	Redline . . . . . 27	Viking . . . . . 121
Crushproof Tubing Co. . . . . 13	Lanair . . . . . 12		VIM Tools . . . . . 112
	Lang . . . . . 29, 113		Water Works . . . . . 125
	Lincoln . . . 39-40, 43, 45-46, 81, 125		Xtra Seal . . . . . 107
	Lisle . . . . . 40, 43, 52, 54-55, 59-60, 62-63, 66, 107, 113, 129, 141, 146		

Prices subject to change without notice. Prices do not include applicable taxes, vehicles, tires, rims, installation or optional equipment as shown. Please do not return purchases to the store. For information regarding warranty, repair, or any questions or concerns, call 901-300-4878.

# NEW ITEMS & DEALS

Offers Good While Supplies Last Through June 30, 2026

## TPMS Bundles

**NEW**

EACH Sensor Comes with a Rubber Valve and a Metal Stem

OEM TOOLS®

### TS37 TPMS Reset, Trigger and Relearn Tool with 4 Sensors

SKU OSB OEMTS374K **279<sup>99</sup>**

- Fast, Simple TPMS Relearns for Most Domestic and Import Vehicles



### VT47 Wi-Fi TPMS Reset and Programming Tool with OBDII with 10 Sensors

SKU OSB OEMVT4710K **599<sup>99</sup>**

- Scan, Diagnose and Relearn TPMS with Built-In OBDII Support



See More **TPMS TOOLS** on Pages 103-104

## Power Tools

OEM TOOLS®

### 6" Bench Grinder with LED Light

SKU OSB 80057 **129<sup>99</sup>**



**NEW**

See More **POWER TOOLS** on Pages 82-84

## Air Conditioning

**NEW LAUNCH**

### AC519 A/C Service Station 134a or 1234yf

SKU OSB LAU703030086YF **3,649<sup>99</sup>**



See More **AIR CONDITIONING** on Pages 14-24

## Diagnostic Cart

**NEW Homak**

### Mobile Diagnostic and Testing Terminal - Blue

SKU OSB HOMBB06019020 **639<sup>99</sup>**



See More **TOOL STORAGE** on Pages 118-121

## Fluid Handling

### Deluxe Heated Cooler Line Flusher, 10 Gal.

SKU OSB FLDGTECTTCF8 **6,749<sup>99</sup>**



FLO-DYNAMICS®  
www.flodynamics.com

**NEW**

See More **FLUID HANDLING** on Pages 44-48

## Shop Equipment

**NEW**

NITROUS KEYS®

### AutoProPAD G3 Evo with Complete Key Making System

SKU OSB NIT20402085



**8,299<sup>99</sup>**

REG. \$9,799.96

**SAVE OVER \$1,499**  
When You Buy the Kit

See More **SHOP EQUIPMENT** on Pages 124-128

## Engine Service

### Harmonic Balancer Puller

SKU OSB 25057 **49<sup>99</sup>**

See More **ENGINE SERVICE** on Pages 59-63



OEM TOOLS®

**NEW**

## Motorcycle Lift Bundle

### Motorcycle Service Essentials Bundle

SKU OSB OEMTPDBNDL **1,499<sup>99</sup>**

- Air/Hydraulic Lift Allows for Manual or Shop Air Operation
- 1200A Jump Starter for 12V Batteries Includes Built-In Inflator: 3 to 150 psi
- 5" Motorcycle Diagnostic Tablet for Fast Troubleshooting
- Supports BMW, Honda, Harley, Ducati, Yamaha, Kawasaki, Suzuki and KTM
- Reads Codes, Clears Codes and Views Live Data
- Supports Common Motorcycle Maintenance Functions

**SAVE\* \$349**



TPDV1200AIR



TPDADMOTO



24859

OEM TOOLS®

TOPDON®

\* Savings based on the price of items if purchased separately.

See More **AUTOMOTIVE LIFTS** on Pages 90-97

Prices subject to change without notice. Prices do not include applicable taxes, vehicles, tires, rims, installation or optional equipment as shown. Please do not return purchases to the store. For information regarding warranty, repair, or any questions or concerns, call 901-300-4878.

## Duralast® TOOL STORAGE

### Duralast 42" 4-Drawer Top Chest, Blue SKU 1354163

- 21-gauge steel construction
- 100 lb. soft-close full-extension drawers with liners
- Built-in power strip (4 outlets & 2 USB ports)
- 7,668 cubic inches of storage
- 400 lb. total weight capacity
- Combine with 1354168 (sold separately)



**359<sup>99</sup>**

### Duralast 30" 5-Drawer Mechanic's Cart BLUE SKU 1354167 BLACK SKU 1354164

- High-capacity, full-extension ball bearing drawer slides
- 90-degree lid opening with dual gas struts
- 15,000 cubic inches of storage
- 700 lb. total weight capacity



**329<sup>99</sup>**

### 42" 9-Drawer Tool Cabinet, Blue SKU 1354168

- 21-gauge steel construction
- 100 lb. soft-close full-extension drawers with liners
- 5"x2" heavy-duty casters to support up to 1,200 lbs.
- 10,532 cubic inches of storage
- 800 lb. total weight capacity
- Combine with 1354163 (sold separately)

**449<sup>99</sup>**

### Duralast 30" 4-Drawer Technician Cart BLUE SKU 1354165 BLACK SKU 1354166

- High-capacity, full-extension ball bearing drawer slides
- 90-degree lid opening with dual gas struts
- 12,600 cubic inches of storage
- 580 lb. total weight capacity



**249<sup>99</sup>**

## SPECIAL DEALS

### Duralast 10PC 1/4", 3/8" Drive 10MM Socket Set SKU 582151

- The Duralast 10pc 10mm socket set takes the need of the 10mm socket, and provides a solution for any application
- Chamfered lead-ins help to provide fast and easy placement of sockets and accessories onto drive



**24<sup>29</sup>**

### Duralast 9PC Triple Square Bit Set SKU 1077622

- Cold formed Alloy Steel socket base and S2 tool steel bit heat treated for superior durability and strength
- Bit sockets attach to drive tools, such as ratchet or breaker bar, providing a long handle for leverage
- Full polished chrome finish socket easily wipes clean of oil and dirt



**26<sup>09</sup>**

## CLEARANCE

### Duralast 1/4", 3/8", 1/2" Drive 335PC Mechanic's Tool Set SKU 1092684 Storage NOT Included

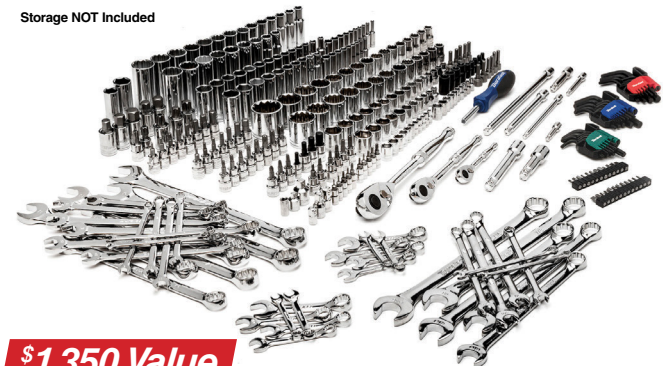

**269<sup>99</sup>\***

**\$1,350 Value**

- Features 210 Chrome Sockets, 41 Wrenches, 3 Ratchets & more!
- Professional Grade Tool Selection, All Guaranteed for Life

\*While supplies last

## Duralast® EVA FOAM SETS



### Introducing the all new Duralast EVA Foam Mechanic Tool Sets

- Premium cut EVA Foam Sets ensure convenient and organized storage
- Professional grade tools, fully guaranteed for life
- Designed to fit in existing Duralast Tool Boxes

#### Duralast

**3PC 100-Position Ratchet Set**  
SKU 1571889

**67<sup>49</sup>**



- 100-position sealed head ratchets provide 3.6° arc swing
- Includes 1/4", 3/8", and 1/2" drive ratchets
- Includes EVA foam tray for convenient storage of ratchets

#### Duralast

**5PC Impact Accessory Set**  
SKU 1571894

**26<sup>99</sup>**



- 6" and 10" length impact extension bars
- 3/8" and 1/2" drive impact adapters
- Includes EVA foam tray for convenient storage of accessories
- Impact grade alloy steel heat treated for superior strength

#### Duralast

**19PC Impact Accessory Set**  
SKU 1146659

**62<sup>99</sup>**



- Ball detent secures sockets to the accessories
- Includes EVA foam tray for convenient storage of accessories
- Alloy steel heat treated for superior strength
- Professional, full polish finish

#### Duralast

**53PC 3/8" Drive Socket Set**  
SKU 1571888

**67<sup>49</sup>**

- Includes EVA Foam tray for convenient storage of ratchet, sockets, and accessories
- 100-position sealed head ratchet
- 6-point standard and deep sockets
- Sockets feature off-corner loading design to help prevent the rounding of fasteners



#### Duralast

**67PC 1/2" Drive Socket Set**  
SKU 1571892

**134<sup>99</sup>**

- Includes EVA foam tray for convenient storage of ratchet, sockets, and accessories
- 100-position sealed head ratchet
- 12-point standard and deep sockets
- Sockets feature off-corner loading design to help prevent the rounding of fasteners

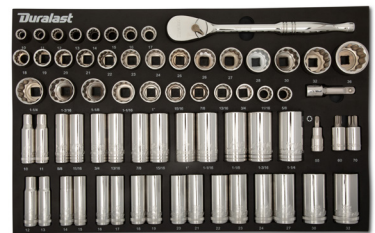

#### Duralast

**80PC Master Bit Socket Set**  
SKU 1571891

**89<sup>99</sup>**

- Hex, Torx®, Tamper-Proof Torx®, External Torx®, Phillips®, Slotted, and Triple Square style bit sockets
- Includes EVA foam tray for convenient storage of ratchets, sockets, and accessories
- 100-position sealed head ratchets
- Premium S2 steel bits for durability



#### Duralast

**34PC Master Combination Wrench Set**  
SKU 1571893

**134<sup>99</sup>**

- 12-point long pattern and stubby combination wrenches (SAE and MM)
- Includes EVA foam tray for convenient storage of wrenches
- Featuring off corner-loading design to help prevent the rounding of fasteners
- 15° offset box ends provides clearance for knuckles



## Duralast® MECHANIC'S TOOL SETS

### Duralast NEW!

**42PC 1/2" Drive Mechanic's Tool Set**  
SKU 1545050

**71<sup>99</sup>**

- 1/2" Drive mechanics tool set
- 12-point standard and deep sockets
- Sockets feature off-corner loading design to help prevent the rounding of fasteners
- Alloy Steel sockets and drive tools heat treated for superior strength



### Duralast NEW!

**60PC Master Bit Set**  
SKU 1545051

**44<sup>99</sup>**

- Hex, Torx®, Tamper-ProofTorx®, External Torx®, Phillips®, Slotted, and Triple Square style bit sockets
- Professional, full polish chrome base
- Premium S2 steel bits for durability
- Chamfered lead-ins for easy placement onto drive tools and fasteners



### Duralast

**265PC Mechanic's Tool Set**  
SKU 1077624

**179<sup>99</sup>**

- 1/4", 3/8", and 1/2" drive mechanic's tool set
- 6-point standard and deep sockets (1/4", 3/8" drive) and 12-point standard sockets (1/2" drive)
- Sockets feature off-corner loading design to help prevent the rounding of fasteners
- Alloy Steel sockets and drive tools heat treated for superior strength



### Duralast

**180PC Mechanic's Tool Set**  
SKU 52378

**119<sup>99</sup>**

- 1/4", 3/8", and 1/2" drive mechanic's tool set
- 6-point standard and deep sockets (1/4", 3/8" drive) and 12-point standard sockets (1/2" drive)
- Sockets feature off-corner loading design to help prevent the rounding of fasteners
- Alloy Steel sockets and drive tools heat treated for superior strength



### Duralast

**90PC Mechanic's Tool Set**  
SKU 52377

**89<sup>99</sup>**

- 1/4" and 3/8" drive mechanic's tool set
- 6-point standard and deep sockets
- Sockets feature off-corner loading design to help prevent the rounding of fasteners
- Alloy Steel sockets and drive tools heat treated for superior strength



### Duralast

**60PC Mechanic's Tool Set**  
SKU 15881

**59<sup>99</sup>**

- 3/8" drive mechanic's tool set
- 6-point standard and deep sockets
- Sockets feature off-corner loading design to help prevent the rounding of fasteners
- Alloy Steel sockets and drive tools heat treated for superior strength



### Duralast

**45PC Mechanic's Tool Set**  
SKU 15879

**39<sup>99</sup>**

- 1/4" drive mechanic's tool set
- 6-point standard and deep sockets
- Sockets feature off-corner loading design to help prevent the rounding of fasteners
- Alloy Steel sockets and drive tools heat treated for superior strength
- Premium S2 steel bits for durability



## Duralast® WRENCHES

### Duralast

#### 6PC Flex-Head Ratcheting Wrench Sets

MM SKU 569808  
SAE SKU 569818

**59<sup>99</sup>**  
each



- 12-point flex head ratcheting combination wrenches
- Ratcheting flex heads allow for accessing fasteners at an angle for improved access
- Featuring off-corner loading design to help prevent the rounding of fasteners



### Duralast

#### 6PC Universal Ratcheting Wrench Sets

MM SKU 570925  
SAE SKU 570926

**34<sup>99</sup>**  
each



- Universal profile ratcheting box-ends allow engagement on 6 fastener types (6-point, 12-point, partially rounded, spline, square, and External Torx®)
- Alloy Steel wrenches heat treated for superior strength
- Chamfered lead-ins for easy placement onto fasteners

### Duralast

#### 6PC Reversible Ratcheting Wrench Sets

MM SKU 570923  
SAE SKU 569807

**59<sup>99</sup>**  
each



- 12-point reversible ratcheting combination wrenches
- Featuring off-corner loading design to help prevent the rounding of fasteners
- Alloy Steel ratcheting wrenches heat treated for superior strength

### Duralast

#### 6PC Ratcheting Wrench Sets

MM SKU 569779  
SAE SKU 570921

**34<sup>99</sup>**  
each



- 12-point ratcheting combination wrenches
- Featuring off-corner loading design to help prevent the rounding of fasteners
- Alloy Steel ratcheting wrenches heat treated for superior strength

### Duralast

#### 2PC Quadbox Ratcheting Wrench Sets

MM SKU 951644  
SAE SKU 951643

**34<sup>99</sup>**  
each



- 12-point metric reversible ratcheting 4-in-1 wrenches
- Each wrench features 4 sizes for convenience
- Alloy Steel ratcheting wrenches heat treated for superior strength
- Reversing levers allow quick directional changes

### Duralast

#### Short Arm T-Handle Hex/Torx Key Sets

9PC MM SKU 1327046  
9PC TORX SAE SKU 1327043  
13PC MM SKU 1327042

**14<sup>39</sup>**  
each



- Short arm hex or torx keys with T-Handle holder
- Ergonomic T-Handle holder provides comfortable grip
- Alloy Steel keys heat treated for superior strength

### Duralast

#### Long Arm T-Handle Hex Key Sets - Ball End

9PC MM SKU 1327045  
13PC SAE SKU 1327047

**15<sup>29</sup>**  
9PC

**14<sup>84</sup>**  
13PC



- Long arm hex keys with T-Handle holder
- Ergonomic T-Handle holder provides comfortable grip
- Alloy Steel keys heat treated for superior strength

## Duralast® LIFT EQUIPMENT & BATTERY CHARGERS

### Duralast GOLD 3 Ton Aluminum Floor Jack SKU 1276166



- Light weight design for easy mobility
- 3 ton capacity dual pump piston with universal release
- Slow descent release



### Duralast GOLD 3-1/2 Ton Professional Foldable Garage Jack SKU 1276164



- 30" lift height with adapter
- Dual piston lift pump
- Slow descent release for controlled load lowering



FEATURE PRICE  
**249<sup>99</sup>**

FEATURE PRICE  
**229<sup>99</sup>**

### Duralast 2.5 Ton Jack & Stands Kit SKU 562996

**99<sup>99</sup>**

- 2.5 ton capacity
- 2.5 ton stands



### Duralast 2.5 Ton SUV Jack SKU 189970

**124<sup>73</sup>**

- Lift range: 5.88" - 20.88"
- 1-year warranty
- Rotatable saddle for easier positioning
- Extra heavy gauge steel chassis frame and side plates for added strength



### Duralast 3 Ton Garage Jack SKU 1399157

**148<sup>49</sup>**

- Lift range: 5.1" - 18.6"
- 1-year warranty
- Rotatable saddle for easier positioning
- Heavy-duty steel construction - high-grade steel with powder-coated finish



### Duralast 6 Ton Jack Stands SKU 234799

**69<sup>99</sup>**

- Full welded heavy gauge steel base
- Large cast iron ratchet pawls for secure locking
- Multiple height positions



### Duralast 6/12V 50A Battery Charger SKU 1541547

- Can detect batteries as low as 1.5V
- Simple operation with charging status, mode, and rate options
- Jump start capabilities for cars, trucks, SUVs
- Boost mode supplies 50A current to quickly recharge depleted batteries

**149<sup>99</sup>**



### Duralast 1200 AMP Vehicle Jump Starter SKU 1541545

**109<sup>99</sup>**

- Can provide 1200A peak current to jump start cars, light trucks, SUVs, and more
- Built-in protections to prevent overcharge, over-voltage, reverse polarity, etc.
- Equipped with 17lb air compressor to re-inflate tires



# HEATING & COOLING

Raise Productivity: Keep Your Technicians Cool And Comfortable

**OEM TOOLS**



Locking Swivel Casters



Hose-Ready Fill Connection



Molded Top Tray

## Evaporative Coolers

**3100 CFM**  
SKU 213184  
23968 **549<sup>99</sup>**

- 1/5 HP 3 Speed Motor
- Water Capacity: 10.3 Gallons
- Cooling Area: 950 Sq. Ft.
- Dimensions: 37" x 17" x 25"
- Weight: 39 Lb.

**5300 CFM**  
SKU 213172  
23969 **699<sup>99</sup>**

- 1/3 HP 3 Speed Motor
- Water Capacity: 14.6 Gallons
- Cooling Area: 1,600 Sq. Ft.
- Dimensions: 45" x 17" x 28"
- Weight: 56 Lb.

### Replacement Media Sets

For 23968/23976  
**3100 CFM**  
SKU 1485034  
HESCP370 **94<sup>99</sup>**

For 23969/23977  
**5300 CFM**  
SKU 1485036  
HESCP610 **139<sup>99</sup>**

**NEW**

## OEMTOOLS FANS

Precision Balanced Blades Reduce Noise and Move More Air

**OEM TOOLS**



### Oscillating Pedestal Fan

**20"**  
SKU OSB 34887 **129<sup>99</sup>**

- 3,320 CFM

**30"**  
SKU OSB 34888 **249<sup>99</sup>**  
• 7,800 CFM

Adjustable-Height Pedestal Cooling with Oscillation and 3-Speed Airflow Control

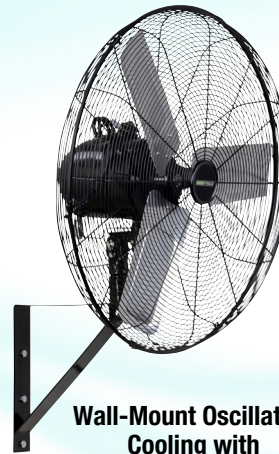

Wall-Mount Oscillating Cooling with High-CFM Airflow and 3-Speed Control

### Indoor Oscillating Wall Mount Fan

**24"**  
SKU OSB 34884 **209<sup>99</sup>**

- 4,216 CFM

**30"**  
SKU OSB 34886 **229<sup>99</sup>**

- 6,387 CFM



### Outdoor Oscillating Wall Mount Fans

- IP44 Water Resistance Rating for Outdoor Use



**24"**  
SKU OSB 34883 **209<sup>99</sup>**

- 5,500 CFM

**30"**  
SKU OSB 34885 **229<sup>99</sup>**

- 7,500 CFM



### 20" High Velocity Floor Fan

SKU OSB 34889 **79<sup>99</sup>**  
• 3,522 CFM

Compact High-Velocity Floor Fan for Targeted Shop, Garage or Bay Cooling



### 42" Direct Drive Barrel Fan

SKU OSB 34890 **539<sup>99</sup>**  
• 17,840 CFM

42" Direct-Drive Barrel Fan Moves Massive Air for Large Work Areas

To Confirm Price, Availability and Ordering Instructions on OSB, Call 901-300-4878

Prices subject to change without notice. Prices do not include applicable taxes, vehicles, tires, rims, installation or optional equipment as shown. Please do not return purchases to the store. For information regarding warranty, repair, or any questions or concerns, call 901-300-4878.

# HEATING & COOLING

TO ORDER, contact your Commercial Sales Manager or go to [AutoZonePro.com](http://AutoZonePro.com)

HEATING & COOLING

## PORTACOOOL

### PEAK COOLING, INTELLIGENT CONTROL

- Portacool APEX™ Series
- Setting the STANDARD for Auto Shop Cooling
- HydroTek™ Evaporative Media – designed to MAXIMIZE cooling performance with less maintenance
- Control Your Comfort with COOLSYNC™ – Sync your Portacools to your smartphone for intelligent control
- Fan Speed
- Wind Direction
- Water Control
- Group Syncing
- Scheduling



PRCA05001A1

#### Apex 500

SKU 1392317  
PRCA05001A1 **1,099<sup>99</sup>**

- Cooling: Up to 500 Sq. Ft.
- Velocity: 40 MPH
- Air Flow Reach: 55 Ft.
- Water: 13 Gal.

#### Apex 700

SKU 1392315  
PRCA07001A1 **1,599<sup>99</sup>**

- Cooling: Up to 700 Sq. Ft.
- Velocity: 37 MPH
- Air Flow Reach: 60 Ft.
- Water: 22 Gal.



PRCA12001A1

#### Apex 1200

SKU 1392332  
PRCA12001A1 **2,399<sup>99</sup>**

- Cooling: Up to 1200 Sq. Ft.
- Velocity: 25 MPH
- Air Flow Reach: 40 Ft.
- Water: 40 Gal.

#### Apex 2000

SKU 1392329  
PRCA20001A1 **3,199<sup>99</sup>**

- Cooling: Up to 2000 Sq. Ft.
- Velocity: 28 MPH
- Air Flow Reach: 60 Ft.
- Water: 45 Gal.



PRCA65001A1

#### Apex 4000

SKU 1392335  
PRCA40001A1 **3,799<sup>99</sup>**

- Cooling: Up to 4000 Sq. Ft.
- Velocity: 25 MPH
- Air Flow Reach: 50 Ft.
- Water: 55 Gal.

#### Apex 6500

SKU 1392341  
PRCA65001A1 **4,999<sup>99</sup>**

- Cooling: Up to 6500 Sq. Ft.
- Velocity: 24 MPH
- Air Flow Reach: 40 Ft.
- Water: 66 Gal.

Customer Responsible For Offloading, Liftgate Service Available | We Offer the Full Line of Portacool and Cool Boss Evaporative Coolers and Accessories

### Evaporative Coolers



- 80W 4000 Lumens Adjustable LED Floodlight
- Anion Negative Ion Air Purifier
- Low Level Shutoff
- Built-In Bluetooth® Audio Player and Speakers
- Wireless Remote Control

#### CB-12L

SKU 1360694  
CLBCB-12SL **1,529<sup>99</sup>**

- Max. Airflow: 1,565 CFM
- Cooling Area: 650 Sq. Ft.
- Fan Diameter: 12"

#### CB-14L

SKU 1400037  
CLBCB-14SL **1,799<sup>99</sup>**

- Max. Airflow: 2,300 CFM
- Cooling Area: 850 Sq. Ft.
- Fan Diameter: 14"

#### CB-16L

SKU 1275460  
CLBCB-16L **2,649<sup>99</sup>**

- Max. Airflow: 4,950 CFM
- Cooling Area: 1,125 Sq. Ft.
- Fan Diameter: 16"

#### CB-28L

SKU 1275461  
CLBCB-28L **3,449<sup>99</sup>**

- Max. Airflow: 9,020 CFM
- Cooling Area: 2,125 Sq. Ft.
- Fan Diameter: 28"

#### CB-36L

SKU 1275465  
CLBCB-36L **4,499<sup>99</sup>**

- Max. Airflow: 12,615 CFM
- Cooling Area: 3,125 Sq. Ft.
- Fan Diameter: 36"



CLBCB-16L

### Blower Fans



#### 300 CFM Blower Fan

SKU 1392323  
MSC20300-A **127<sup>99</sup>**

- 120 Volts, 60 Hz
- For Indoor or Outdoor Use
- 3-Speed Switch (High, Medium, Low)
- 4-Position Adjustment Feet
- 8.5 Ft. Cord Length



#### Heater Attachment for 300 CFM Blower

SKU OSB  
MSC20300-HTR **69<sup>99</sup>**

- Converts Your 300 CFM Portable Blower into a Heater for Your Garage or Work Space
- 1320 Watts, 5000 BTU
- Fits Many Popular Brands (300 CFM Only. Not for 1,200 CFM Fans.)



For OSB, Call 901-300-4878

Prices subject to change without notice. Prices do not include applicable taxes, vehicles, tires, rims, installation or optional equipment as shown. Please do not return purchases to the store. For information regarding warranty, repair, or any questions or concerns, call 901-300-4878.

# HEATING & COOLING

## EnergyLogic



On-board  
air compressor



Burn No.2 to 90W  
and synthetics



Small  
footprint



ENL11075104

**Stop paying to have your waste oil hauled off!**  
Save and burn it for **FREE** heat this winter.

### 75H Waste Oil Furnace with Built-In 10 Gal. Tank

FURNACE	BTUs	HEATS UP TO	PART NO.	PRICE
EL-75	75,000	1,750 Sq. Ft.	ENL11075104	<b>4,299.99</b>

### Waste Oil Heater Complete Systems\*

FURNACE	BTUs	HEATS UP TO	PART NO.	PRICE
EL-140	140,000	3,500 Sq. Ft.	ENL01140103	<b>11,649.99</b>
EL-200	200,000	5,000 Sq. Ft.	ENL01200104	<b>12,899.99</b>
EL-350	350,000	8,500 Sq. Ft.	ENL01350104	<b>15,549.99</b>

For OSB, Call 901-300-4878

\* Complete systems include waste oil furnace and 250 gallon tank, swing-away burner with built-in air compressor, low-fuel cutoff, draft gauge, drain valve and Class A flue kit.



ENL01140103

FOR BEST PRICING,  
Call 901-300-4878

Not for Sale in CA

## Lanair

# EXTREME PERFORMANCE BURNER

**FREE Strainer Pan & Tank Gauge Included!**

	Heater Package*	BTUs	Heats up to	Part Number	Price
Thru-roof chimney	XT150C	150,000	3,500 Sq. Ft.	LANXT150C	<b>10,449.99</b>
	XT200C	200,000	5,000 Sq. Ft.	LANXT200C	<b>10,799.99</b>
	XT250C	250,000	8,500 Sq. Ft.	LANXT250C	<b>13,849.99</b>
	XT300C	300,000	10,00 Sq. Ft.	LANXT300C	<b>14,599.99</b>

\* Packages Include 215 Gallon Tank and 6" Chimney Kit

For OSB, Call 901-300-4878

Not for Sale in CA



LANXT150C

## Sunfire

### Portable Radiant Heaters

- Built-In Safety Features – Equipped with Tip-Over Protection, Flame-Out Sensors, and Automatic Shutoff Systems to Ensure Safe Operation in Commercial and Indoor Settings
- Infrared Radiant Heating: Clean, Quiet and Odorless
- Built for Portability
- Thermostat-Ready and UL-Listed for Indoor/Commercial Use
- Made in the USA with Strong Support

**NO SMELL NO FUMES**



SFRSF120

Part Number	BTU's	Heats up to	Fuel	Tank	Price
SFRSF80	80,000	1,900 Sq. Ft.	Dual Fuel (Diesel/Kerosene)	6 Gal.	<b>1,799.99</b>
SFRSF120	120,000	2,800 Sq. Ft.	Dual Fuel (Diesel/Kerosene)	14 Gal.	<b>2,499.99</b>
SFRSF160	160,000	3,500 Sq. Ft.	Dual Fuel (Diesel/Kerosene)	19 Gal.	<b>3,499.99</b>

For OSB, Call 901-300-4878 Commercial/Shop Use Only | Use in Well-Ventilated Areas | Not for Residential Living Areas

To Confirm Price, Availability and Ordering Instructions on OSB, Call 901-300-4878

Prices subject to change without notice. Prices do not include applicable taxes, vehicles, tires, rims, installation or optional equipment as shown. Please do not return purchases to the store. For information regarding warranty, repair, or any questions or concerns, call 901-300-4878.

# HEATING & COOLING

TO ORDER, contact your Commercial Sales Manager or go to [AutoZonePro.com](http://AutoZonePro.com)

HEATING & COOLING

## Exhaust Hoses

### Flarelock Hoses

- Made Exclusively for Cars and Small Trucks
- End is Flared to Permit Connection of 2 or More Links at a Time



**2.5" x 11'**  
SKU 977557  
ACSF250 **129<sup>99</sup>**

**3" x 11'**  
SKU 977559  
ACSF300 **159<sup>99</sup>**

**3.5" x 11'**  
SKU 977589  
ACSF350 **224<sup>99</sup>**

**4" x 11'**  
SKU 977590  
ACSF400 **244<sup>99</sup>**

### 3" Y-Assembly Kit with F300 Adapter

SKU 977550  
ACSYA300  
**264<sup>99</sup>**



## CRUSHPROOF TUBING COMPANY

### Door Port Adapters

#### For 2.5" Hose (Rubber)

SKU 977551  
ACSD25 **59<sup>99</sup>**



- Rubber Garage Door Port Adapter
- Designed for 2-1/2" ID

#### For 3" Hose (Aluminum)

SKU 977552  
ACSA30 **59<sup>99</sup>**



- Aluminum Port Allows Hose to Be Vented Through the Door

#### For 4" Hose (Aluminum)

SKU 977554  
ACSA40 **89<sup>99</sup>**



- Use on 1" Thick Doors

### 2.5" Service Station Kit

SKU 977547  
ACSDSS25 **274<sup>99</sup>**

- 2 Each - 4' x 2-1/2" Hoses
- 1 Each - 6' x 2-1/2" Hose
- 1 Each - 2-1/2" Rubber "Y" Connector
- 2 Each - Straight Tailpipe Adapter, Hook and Chain
- 1 Each - Splice Connector



### 3" Service Station Kit

SKU 977548  
ACSDSS30 **279<sup>99</sup>**

- 2 Each - 4' x 3" Hoses
- 1 Each - 6' x 3" Hose
- 1 Each - 3" Rubber "Y" Connector
- 2 Each - Straight Tailpipe Adapter, Hook and Chain
- 1 Each - Splice Connector



### Bell Hose Adapters

- Designed for Easy Adapting to All Sorts of Tailpipes
- Connects with Ball and Snap

#### 2.5" Adapter

SKU 977544  
ACSRA250 **59<sup>99</sup>**



#### 3" Adapter

SKU 977545  
ACSRA300 **59<sup>99</sup>**

# SYLVANIA

#1 AFTERMARKET AUTOMOTIVE LIGHTING BRAND IN THE USA<sup>1</sup>

**NEW!**

## LED ULTRA + LED FOG + POWERSPORTS BULBS

BRIGHTEST LED<sup>3</sup>

SYLVANIA LED ULTRA



### PERFORMANCE, LONGEVITY + STYLE

- COOL WHITE LIGHT
- DIRECT REPLACEMENT<sup>4</sup>
- MAXIMUM LIFESPAN
- FOR LED ULTRA NIGHT VISION



BRIGHT LED

SYLVANIA LED



### PERFORMANCE + STYLE

- COOL WHITE LIGHT
- DIRECT REPLACEMENT<sup>4</sup>
- MAXIMUM LIFESPAN



BEST

SILVERSTAR ULTRA



### FARTHEST DOWNROAD + WHITER LIGHT<sup>3</sup>

BETTER

SILVERSTAR



### FARTHER DOWNROAD + WHITER LIGHT<sup>3</sup>

GOOD

XTRAVISION



### FARTHER DOWNROAD<sup>3</sup>

# SYLVANIA OFF ROAD

## LED OFF ROAD LIGHTBARS + PODS



LIFETIME LIMITED WARRANTY<sup>2</sup>



- Superior optical engineering
- Durable design
- Water resistant (IP67 or IP69K)

<sup>1</sup>Circana/U.S. Retail Tracking Service, May 3, 2025 <sup>2</sup>See packaging for details <sup>3</sup>Compared to SYLVANIA BASIC <sup>4</sup>Fog or powersports use only

Prices subject to change without notice. Prices do not include applicable taxes, vehicles, tires, rims, installation or optional equipment as shown. Please do not return purchases to the store. For information regarding warranty, repair, or any questions or concerns, call 901-300-4878.

# AIR CONDITIONING

FOR MORE DETAILS ON RECOVERY MACHINES GO TO AZTOOL1.COM

## Recovery Machines

### ArcticPRO®



Warranty:  
2 Years Parts and 1 Year Labor

MSSACX2180

MAHLE	Refrigerant 134a			Refrigerant 1234yf	
	ACX-2150 R134a Recovery Machine SKU 213170 MSSACX2150	ACX-2180 R134a Recovery Machine SKU 213168 MSSACX2180	ACX-2180H R134a Hybrid Recovery Machine SKU 213203 MSSACX2180H	ACX-2250 R1234yf Recovery Machine SKU 213151 MSSACX2250	ACX-2280 R1234yf Recovery Machine SKU 1187032 MSSACX2280
Automatic Oil Drain	✓	✓	✓	✓	✓
Automatic Air Purge	✓	✓	✓	✓	✓
Included Database	Optional	✓	✓	Optional	✓
Automatic Oil and Dye Injection	✓	✓			
Includes Refrigerant Identifier				✓**	✓*
Phone Application	Optional	✓	✓	Optional	✓
<b>Price</b>	<b>4,399<sup>99</sup></b>	<b>5,099<sup>99</sup></b>	<b>5,099<sup>99</sup></b>	<b>6,299<sup>99</sup></b>	<b>7,349<sup>99</sup></b>

On-Board Integrated Thermal Printer (Optional) \*Integrated \*\*Non-Integrated

### ECOTECHNICS®



Training Videos



Warranty:  
1 Year Parts and Labor

HOFEEAC800

Description	Hybrid Ready R134a SKU 1339733 HOFEEAC820B	Hybrid Ready R1234yf SKU 1335790 HOFEEAC830B	Eco Dual Gas A/C Service Station SKU 1335792 HOFEEAC800
Refrigerant Type	R134a	HFO-1234yf	R134a + HFO1234yf
Refrigerant Tank	30 Lb.	30 Lb.	30 Lb. + 30 Lb.
Command Valves	Automatic	Automatic	Automatic
Display	5" Touch	5" Touch	7" Touch
Database	✓	✓	✓
Printer	✓	✓	✓
Status Light	✓	✓	✓
Hybrid Function	✓	✓	✓
<b>Price</b>	<b>4,949<sup>99</sup></b>	<b>6,599<sup>99</sup></b>	<b>10,809<sup>99</sup></b>

### KONFORT



Warranty:  
2 Years Parts and Labor

TEXA17810

TEXA	750R R134a Recovery Machine SKU 1282745 TEXZ11450	760 R1234yf Recovery Machine SKU 1282756 TEXA17910	780 Dual Gas Recovery Machine SKU 1282809 TEXA17810
Automatic Oil Drain	✓	✓	✓
Automatic Oil and Dye Injection	✓		
10" Multi-Touch Display		✓	✓
R134a Management	✓		✓
R1234yf Management		✓	✓
Vehicle Capacity Database	✓	✓	✓
Software Update Over Wi-Fi		✓	✓
Push-Pull Recovery	✓	✓	✓
Fully Automatic Operation	✓	✓	✓
<b>Price</b>	<b>5,399<sup>99</sup></b>	<b>8,749<sup>99</sup></b>	<b>10,549<sup>99</sup></b>

Prices subject to change without notice. Prices do not include applicable taxes, vehicles, tires, rims, installation or optional equipment as shown. Please do not return purchases to the store. For information regarding warranty, repair, or any questions or concerns, call 901-300-4878.

# AIR CONDITIONING

TO ORDER, contact your Commercial Sales Manager or go to [AutoZonePro.com](http://AutoZonePro.com)

AIR CONDITIONING

## Recovery Machines

**ROBINAIR.**



ROBAC1234-9

Warranty:  
1 Year Parts and Labor

Description	AC1234-4 Premier R1234yf SKU 1212384 ROBAC1234-4	AC1234-9 Connected R1234yf ACS SKU 1212383 ROBAC1234-9	34288NI Economy R134a SKU 221185 ROB34288NI	34788NI-H Premier R134a Refrigerant for Hybrid and Non-Hybrid Vehicles SKU 751572 ROB34788NI-H	34788NI Premier R134a Refrigerant SKU 751569 ROB34788NI	34998 Connected R134a ACS SKU 1212385 ROB34998
Operation	Automatic	Automatic	Semi-Automatic	<ul style="list-style-type: none"> <li>Automatic</li> <li>Hybrid Vehicle Applications</li> </ul>	<ul style="list-style-type: none"> <li>Automatic</li> <li>Auto Oil Injection</li> </ul>	<ul style="list-style-type: none"> <li>Automatic</li> <li>Auto Oil Injection</li> </ul>
Display	4.3" LCD Display	10" Hi-Res Touch Screen	4.3" Full Color Display	4.3" Full Color Display	4.3" Full Color Display	10" Hi-Res Touch Screen
Printer	ROB30038 (optional)	Wireless Printing	ROB30038 (optional)	ROB30038 (optional)	ROB30038 (optional)	Wireless Printing
Bluetooth and Wi-Fi		✓				✓
<b>Price</b>	<b>6,850<sup>99</sup></b>	<b>7,700<sup>99</sup></b>	<b>4,250<sup>99</sup></b>	<b>5,150<sup>99</sup></b>	<b>5,150<sup>99</sup></b>	<b>6,165<sup>99</sup></b>

**MSX**



CPSMSX3030

Warranty:  
2 Years Parts and Labor

<b>cps</b>	R134a SKU 1407803 CPSMSX134	R1234yf SKU 1407806 CPSMSX1234	R134a/R1234yf SKU 1407510 CPSMSX3030	Heavy Duty R134a SKU 1407805 CPSMXHD
Fully Automatic	✓	✓	✓	✓
Onboard Oil Injection	✓			
High Capacity Oil-less Compressor	✓	✓	✓	✓
Vehicle Database Included	✓	✓	✓	✓
10 Ft. Service Hoses	✓	✓	✓	18' Hose
Includes 2 Tanks and 2 Sets of Hoses			✓	
Wi-Fi and Bluetooth Enabled	✓	✓	✓	✓
Touch Screen	7" Hi-Res	7" Hi-Res	7" Hi-Res	7" Hi-Res
Includes Refrigerant Identifier		✓	✓	
Converts Between R134a and R1234yf in 10 Min.			✓	
<b>Price</b>	<b>5,149<sup>99</sup></b>	<b>6,799<sup>99</sup></b>	<b>8,799<sup>99</sup></b>	<b>7,999<sup>99</sup></b>

## Recovery Machine Filters/Maintenance Kits

**ROBINAIR.**

**cps**

**Mastercool**  
"World Class Quality"

**MAHLE**

**ECOTECHNICS**

SKU	Part Number	Brand	Fits	Price
OSB	ROB34430	Robinair	17700A, 34450, 34700, 34134Z	<b>164.99</b>
OSB	ROB34724	Robinair	34288, 34788, 34788NI, 34788NI-H, 34988, 347002, 34134Z	<b>118.99</b>
OSB	ROB13172	Robinair	Maintenance Kit for Models Using 34724 Filter - Includes Oil	<b>99.99</b>
186483	CPSARXF5	CPS	FX and AR Series CPS Equipment	<b>99.99</b>
1149172	CPSFX3030X1	CPS	Includes FX Series Filter, Vacuum Pump Oil and Coupler O-Rings for FX134A	<b>154.99</b>
389222	MSC69788FLTPK	Mastercool	69788, 69789 and 69789-H	<b>219.99</b>
199681	MSCCOM1FLTRPK	Mastercool	Commander 4000 and 4000x	<b>169.99</b>
199675	MSCCOM2FLTRPK	Mastercool	Commander 1000, 2000 and 3000	<b>219.99</b>
1149182	MSS3608325400	Mahle	ACX2180, ACX2180H, ACX2286 and ACX2280	<b>149.99</b>
207349	MSS268077600	Mahle	ACX1120H, ACX1150, ACX1150H and ACX2120H	<b>109.99</b>
207508	MSS3608273900	Mahle	ACX1280, ACX2150 and ACX2250	<b>109.99</b>
818739	RTI3608213300	Mahle	RHS980 and ACX1180	<b>104.99</b>
1406968	HOFEEAC33023B	EcoTechnics	HOFEEAC800, HOFEEAC810, HOFEEAC820B and HOFEEAC830B	<b>99.99</b>

For OSB, Call 901-300-4878

Prices subject to change without notice. Prices do not include applicable taxes, vehicles, tires, rims, installation or optional equipment as shown. Please do not return purchases to the store. For information regarding warranty, repair, or any questions or concerns, call 901-300-4878.

AZG0226

# AIR CONDITIONING

## A/C VACUUM PUMP KITS - BETTER VALUE FOR YOUR MONEY

### Starter A/C Vacuum Pump Kit - R134a



SKU 1400034  
68950

- Includes: 1.8 CFM, 100 Micron Single Stage Vacuum, Professional Quality Extruded Aluminum Manifold with 72" Hoses, High Quality Manual Couplers and R134a Can Tap



**249<sup>99</sup>**  
REG. \$284.97

SAVE \$34  
OVER

When You Buy the Kit

### R134a and R1234yf Spark-Free A/C Vacuum Pump Kit



SKU 1400036  
68951

- Includes: 6 CFM, 75 Micron, Spark-Free Single Stage Vacuum for Use with R134a or R1234yf, Extruded Aluminum Manifold Gauges, 72" Hoses with High Quality Manual Couplers, R1234yf Conversion Couplers That Convert R134a Manifold and Hoses to R1234yf, 1/2" ACME Right Hand to 1/2" ACME Left Hand Tank Adapter, 1/4" SAE x 1/2" ACME Hose to Vacuum Pump Adapter and R134a and R1234yf Can Tap



**349<sup>99</sup>**  
REG. \$404.98

SAVE \$54  
OVER

When You Buy the Kit

### Professional A/C Kit - R134a



SKU OSB  
MSC134APROKIT

- Includes: 3 CFM, 80 Micron Single Stage Vacuum Pump, Professional Quality Extruded Aluminum Manifold with Sight Glass, 96" Hoses, Manual Couplers and Easy-to-Read Spring Dampened Gauges to Reduce Flutter, Electronic Leak Detector Sensitive to 0.1 Oz./Year, and 3-in-1 Side Mount Can Tap Fits 1 Lb. Cans of R134a



**469<sup>99</sup>**  
REG. \$609.96

SAVE \$139  
OVER

When You Buy the Kit

### Electronic Leak Detection

#### A/C Refrigerant Leak Detector

SKU 466307  
24510 **119<sup>99</sup>**

#### Detects All Types of Halogenated Refrigerants

- Sensitive to 0.1 Oz. per Year Single Color LED Display with 7 Level Leak Alarm
- Flexible Stainless Steel Probe to Reach Almost Any Space
- Includes Spare Sensor Tip



#### Black Series Infrared Refrigerant Leak Detector

SKU OSB  
MSC55600-A **584<sup>99</sup>**

- Easily Select Sensitivity Levels with a Maximum Sensitivity Up to 0.14 Oz./Yr.
- TFT Screen Provides Clear and Easy Readings That Show Leakage, Sensitivity, Battery Level and Sensor Fault Indicators
- Designed to Meet EN14624, SAE1627, SAE2791 and SAE2913 Standards



#### Raptor Refrigerant Leak Detector

SKU 916550  
MSC56100 **259<sup>99</sup>**

- Features 3 Sensitivity Levels and 5 Detection Levels
- Detects Leaks as Small as 1/10 Oz. per Year
- Detects All Refrigerants (CFC, HCFC, HFC)
- Flexible 16" Probe for Hard-to-Reach Areas



#### Inspector 2-in-1 Electronic/UV Leak Detector

SKU 916553  
MSC56200 **309<sup>99</sup>**

- Pinpoint Leaks as Small as 1/10 Oz. (3 gr) Per Year
- Built-In Ultra-Bright UV Light at End of Probe - Allowing Easy Access into Tight Areas



To Confirm Price, Availability and Ordering Instructions on OSB, Call 901-300-4878

### Portable Recovery Systems

#### R-134 Twin Turbo Complete Recovery Machine

SKU OSB  
MSC69360 **1,749<sup>99</sup>**

- Largest Volume Recovery Rate on the Market
- For Use with All Refrigerants Including R410A
- Injection Molded High Density Polyethylene Case for Maximum Durability
- Safety High Pressure Switch
- Revolutionary Double Piston Oil-Less Compressor



#### R1234yf Twin Turbo Complete Recovery Machine

SKU OSB  
MSC69360-YF **2,149<sup>99</sup>**

- Revolutionary Double Piston Oil-Less Compressor
- Largest Volume Recovery Rate on the Market
- Includes: 30 Lb. DOT Tank, Sight Glass, R1234yf Low Side Coupler, Oil Drain Bottle and R1234yf Blue and Yellow Hoses



#### R134a/R1234yf Complete A/C Recovery Set

SKU OSB  
MSC69372 **2,379<sup>99</sup>**

- Built with the Safest Spark-Free Components
- Includes: All Hoses and Couplers Needed to Recover, Cleanse and Remove the Oil from R134a and R1234yf Automotive A/C Systems
- 30 Lb. DOT Tank for R134a and 30 Lb. DOT Tank for R1234yf Refrigerants Included with Each Unit (Refrigerant Sold Separately)
- 115V/60 Hz
- 1/2 HP Oil-Less Compressor
- Compatible Refrigerants: All CFCs, HCFCs and HFCs



## Vacuum Pumps

### 1.8 CFM Single Stage Vacuum Pump

SKU 466312 **149<sup>99</sup>**  
24500

- Motor: 1/4 HP, 110V
- Ultimate Vacuum Rating: 100 Microns
- Inlet Ports: 1/2" ACME - 1/4" Flare
- Oil Capacity: 6.7 Oz. (200 mL), Included
- Internal High Volume Cooling Fan for Extended Use



### 4 CFM Single Stage Vacuum Pump

SKU 466305 **209<sup>99</sup>**  
24501

- Motor: 1/3 HP, 110V
- 75 Microns
- Inlet Ports: 1/2" ACME 1/4" Flare
- Oil Capacity: 11 Oz. (330 mL), Included
- Internal High Volume Cooling Fan for Extended Use



### 6 CFM Single Stage Vacuum Pump

SKU 466306 **259<sup>99</sup>**  
24502

- Motor: 1/2 HP, 110V
- 75 Microns
- Inlet Ports: 1/2" ACME - 1/4" Flare
- Oil Capacity: 11 Oz. (330 mL), Included
- Internal High Volume Cooling Fan for Extended Use



### 6 CFM Spark-Free Vacuum Pump

SKU 213133 **299<sup>99</sup>**  
24642

- Motor: Spark-Free 1/2 HP, 110V
- Ultimate Vacuum Rating: 75 Microns
- 3 Inlet Ports: 1/4" Flare, 1/2" ACME and 1/2" ACME LH
- Oil Capacity: 330 mL, Included
- Internal High Volume Cooling Fan for Extended Use
- Can Be Used with R1234yf Refrigerant



### Black Series 1.8 CFM Single Stage Vacuum Pump

SKU 1414397 **184<sup>99</sup>**  
MSC90059-BL

- 80 Microns
- 1/4 HP
- 110/120, 60 Hz
- T-Fitting 1/4" FL-M x 1/2 ACME-M



### 3 CFM Single Stage Vacuum Pump

SKU 1392324 **199<sup>99</sup>**  
MSC290062

- Large Fan Keeps Vacuum Pump Cooler and Extends Life
- 1/4" SAE and 1/2" ACME Port Access
- 110-120V, 60 Hz Voltage



### 6 CFM 2 Stage Vacuum Pump

SKU OSB **449<sup>99</sup>**  
MSC900662V-BL

- 15 Microns
- 1/2 HP
- 110/220, 50/60 Hz
- Includes: 3 Inlet Ports: 1/4", 3/8" SAE and 1/2" ACME



For OSB, Call 901-300-4878

### R1234yf Manifold/Hose Adapter Assortment

SKU 1142732 **32<sup>99</sup>**  
25091

- 6 Common Adapters to Fit Manifolds, Hoses, Couplers and Vacuum Pumps
- Includes: 1/2" LH ACME Female x 1/4" Male Flare, 1/2" ACME Male x M12 x 1.5 Male, 1/2" ACME Female x M12 x 1.5 Female, 1/4" Male Flare x M12 x 1.5 Male, 1/2" LH ACME Female x M14 QDK, 1/2" LH ACME Male x 1/4" Female Flare
- Includes: Organizer Case with I.D. Labels



### Vacuum Pump Oil (8 Oz.)

SKU OSB **10<sup>00</sup>**  
24399

- Increases Life Span of the Pump
- Performance of Your Pump Depends on Regular Service and the Quality and Purity of the Vacuum Pump Oil That You Use
- Compatible for Use in Pumps Made by Most Manufacturers



For OSB, Call 901-300-4878

### Premium Vacuum Pump Oil 1 Quart Bottle

SKU 517580 **19<sup>99</sup>**  
CPSVPOQ12

- Increases Life Span of the Pump
- Performance of Your Pump Depends on Regular Service and the Quality and Purity of the Vacuum Pump Oil That You Use
- Compatible with Most Pumps



### R1234yf Hose to Vacuum Pump Adapter Fitting 1/4" x 1/2"

SKU 600806 **19<sup>99</sup>**  
24509

- 1/4" SAE x 1/2" ACME Female LH Thread



**STORE STOCKED**

# AIR CONDITIONING

## Manifold Gauges

### R1234yf Manifold Gauge and Hose Set

SKU 752518 **229<sup>99</sup>**  
24559

- 3" Easy-to-Read Gauges with Temperature Chart
- 72" Hoses
- High Quality 6-Ball Manual Couplers

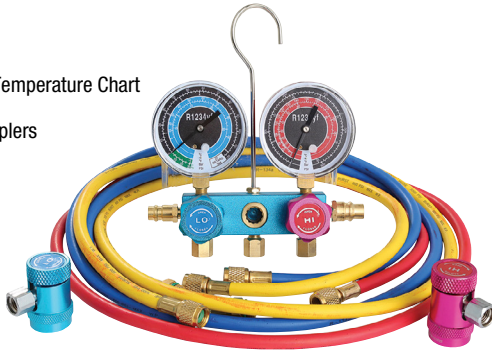

OEM TOOLS

### Dual Aluminum R134a/R1234yf Gauge Set

SKU 1335797 **239<sup>99</sup>**  
25130

- Includes: 72" Hoses, Manual Couplers and Can Tap Valves with 1/2" ACME Fittings for Use with Both R134a and R1234yf Refrigerants

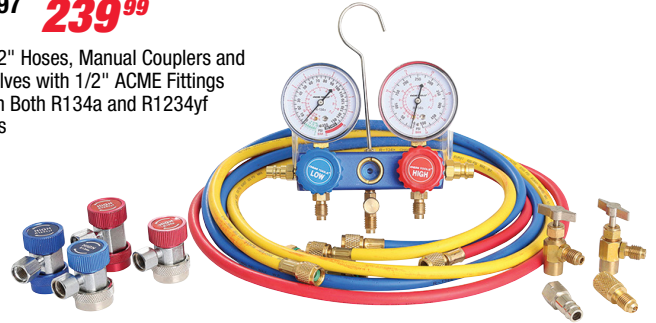

OEM TOOLS

### R134a Brass Manifold Gauge Set

SKU 752520 **129<sup>99</sup>**  
24563

- High Quality Brass Body with Sight Glass
- Large 2-1/2" Gauges are Easy to Calibrate and Have a High Impact Lexan Lens
- 60" Hoses (3,000 psi Burst, 600 psi Working Pressure)
- Snap Style Quick Couplers

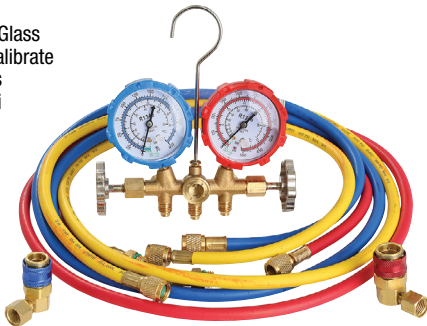

OEM TOOLS

### R134a Manifold Gauge and Hose Set

SKU 466319 **129<sup>99</sup>**  
24527

- Easy-to-Read 2-3/4" Spring Dampened Gauges to Reduce Flutter
- Extruded Aluminum Manifold
- 72" Hoses with Manual Couplers

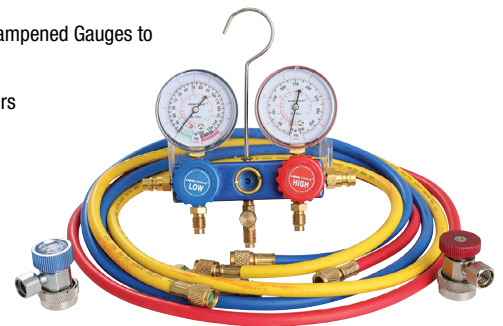

OEM TOOLS

### Dual R134a, R-12 Manifold Gauge Set

SKU 1335804 **131<sup>99</sup>**  
MSC293996PBCL

- Solid Block Extruded Aluminum Manifold
- 96" Long Hoses with Manual Couplers
- Gauge Guards for Protection
- Silicone Dampened Calibratable Gauges
- Extra Long Hose for Access to Heavy Duty Buses, Fleet and Refrigerated Trucks Systems

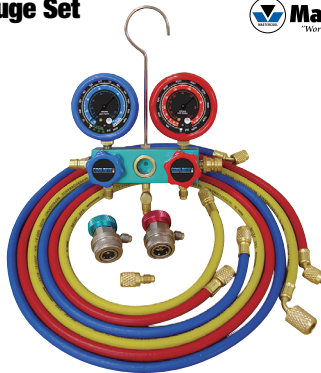

Mastercool  
World Class Quality

### Dual R134a/R1234yf Brass Gauge Set

SKU 1142631 **182<sup>99</sup>**  
MSC66661AYF

- 2-1/2" Silicone Dampened, Recalibratable Gauges
- Extra Access Port for Vacuum Line
- R1234yf High and Low Side Quick Couplers
- R134a High and Low Side Economy Couplers
- 1/2" ACME-M x 1/2" ACME-F LH Thread Adapter (2) 12 mm-M x 14 mm-F R1234yf Adapters Set of 3 - R134a Standard Hoses



Mastercool  
World Class Quality

### R1234yf Aluminum Manifold Gauge Set

SKU 505065 **274<sup>99</sup>**  
MSC83272

- Ideal for Shops That Want to Wait to Invest in New AC Service Stations Adapted for R1234yf
- Contains Manifold, 3 Service Hoses, 2 Service Couplers LT/HT

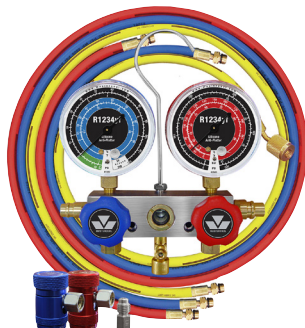

Mastercool  
World Class Quality

### Dual Aluminum R134a/R1234yf Gauge Set

SKU 1086254 **316<sup>99</sup>**  
MSC89661AYF

- Professional Extruded Aluminum Block
- 2-1/2" Silicone Dampened, Re-Calibratable Gauges
- Free-Floating Piston Type Valves Reduce O-Ring Wear
- R1234yf High and Low Side Couplers with Extended Disconnect Protection Sleeve
- Standard Hoses, R134a Manual Couplers, R1234yf Couplers, 1/2" ACME-M x 1/2" ACME-F LH Thread Adapter, (2) 12 mm-M x 14 mm-F R1234yf Adapters



Mastercool  
World Class Quality

Prices subject to change without notice. Prices do not include applicable taxes, vehicles, tires, rims, installation or optional equipment as shown. Please do not return purchases to the store. For information regarding warranty, repair, or any questions or concerns, call 901-300-4878.

# AIR CONDITIONING

TO ORDER, contact your Commercial Sales Manager or go to [AutoZonePro.com](http://AutoZonePro.com)

AIR CONDITIONING

## Can Taps

**R1234yf Self-Sealing Can Tap**  
SKU 213178 24553 **14<sup>99</sup>**

**R134a Can Tap**  
SKU 466315 24524 **14<sup>99</sup>**



**4-Way Side Can Tap**  
SKU 1103203 FJC6842 **34<sup>99</sup>**

- For Use with R-12, R134a or R1234yf Refrigerant Cans and Oil Change Cans
- Fits Cans with 2-7/8", 2-1/2" and 2" Diameter
- Includes: 1/2" ACME LH, 1/2" ACME and 1/4" Flare Male Fitting with Check Valve

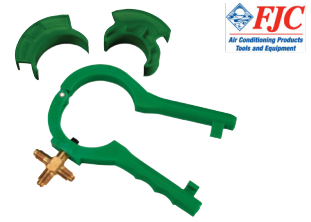

**Refrigerant and Oil Charge Side Can Tap**  
SKU 466313 24523 **27<sup>99</sup>**

- Fits 1 Lb. Cans of R134a, R12 and 2" Oil Charge Cans
- Plier Type Grip with Positive Lock
- Includes: 1/2" ACME Male and 1/4" FL Male Ports with Safety Valve



**3-In-1 Side Mount Can Tap**  
SKU 290033 MSC85530 **17<sup>99</sup>**

- Unique Design will Work on All R134a (2-7/8"), R12 (2-1/2") and Oil Charge (2") Cans
- Outlet Port Offers a 1/2" ACME and 1/2" FL Fitting with an Internal Check Valve to Prevent System Backflow



## Manifold Gauge Repair

**Replacement Gauge High Side for A/C Manifold**  
SKU 481705 24530 **10<sup>99</sup>**

- Replacement High Side Gauge Fits OEMTOOLS® and Other Brands of A/C Manifolds Used to Service A/C Systems on Cars
- 1/8" NPTF Male Threads
- Reads 0 to 500 psi



**Replacement Gauge Low Side for A/C Manifold**  
SKU 481709 24531 **9<sup>99</sup>**

- Reads 0 to 120 psi and 0 to 30" Hg



**A/C Manifold Upgrade Kit**  
SKU 1043688 68903

- Includes: 3-in-1 Side Mount Can Tap Valve, R134a Manual Coupler Set, 1234yf Self Sealing Can Tap, 1/2" ACME Hose Set 72", R134a to HFO-1234yf Conversion Coupler Set



**139<sup>99</sup>**  
REG. \$199.95

**SAVE \$59 OVER**  
When You Buy the Kit

**R1234yf Manifold/Hose Adapter Assortment**  
SKU 1142732 25091 **29<sup>99</sup>**

- 6 Common Adapters to Fit Manifolds, Hoses, Couplers and Vacuum Pumps
- Includes: 1/2" LH ACME Female x 1/4" Male Flare, 1/2" ACME Male x M12 x 1.5 Male, 1/2" ACME Female x M12 x 1.5 Female, 1/4" Male Flare x M12 x 1.5 Male, 1/2" LH ACME Female x M14 QDK, 1/2" LH ACME Male x 1/4" Female Flare
- Includes: Organizer Case with I.D. Labels

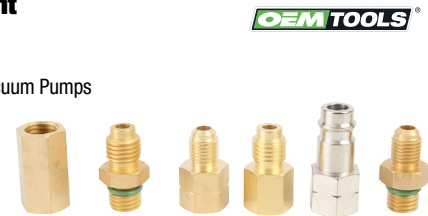

**R134a/R12 Charging Hose Repair Kit**  
SKU 295557 MSC91334-A **28<sup>99</sup>**

- 50 Piece Assortment of Replacement Gaskets, O-Rings, Depressors for Charging Hoses and Adapters



**72 Pc. Valve and Gasket Set**  
SKU 1544670 25099 **17<sup>99</sup>**

- Includes: 50 Common Gaskets for 134a Hoses and Manifold Sets, 10 Replacement Valves and 10 Replacement Valve Cores
- Includes: Valve Core Replacement and Installation Tool and Organizer Case



## A/C Hoses

**96" R134a Red Hose**  
SKU 489152 MSC84963 **34<sup>99</sup>**

- 1/2" ACME-F and 14 mm-M Auto A/C Fittings - 96"



**96" R134a Blue Hose**  
SKU 489151 MSC84961 **34<sup>99</sup>**

- 1/2" ACME-F and 14 mm-M Auto A/C Fittings - 96"



**72" R134a Hose Set**  
SKU 752516 24558 **59<sup>99</sup>**

- 3 Color Coded Hose: Red, Yellow and Blue

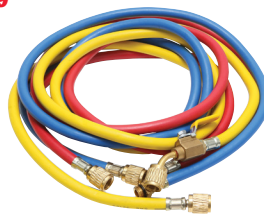

**96" 2 Pc. 1234yf Recovery Hose Set**  
SKU OSB 25010 **36<sup>99</sup>**

- Includes: 96" Set Blue/Red 12 mm-M x 12 mm-M
- Meets or Exceeds SAE J2888 Standards

**72" 1/4" SAE Hose Set**  
SKU 752515 24557 **46<sup>99</sup>**

- 3 Color Coded Hose: Red, Yellow and Blue



**72" 3 Pc. R1234yf Hose Set**  
SKU OSB 25009 **42<sup>99</sup>**

- Includes: (2) 72" High/Low Charging Hoses with 12 mm Male Fittings and 72" Charging Hose with 12 mm and 1/2" x 16" Left Hand Acme Fitting
- Meets or Exceeds SAE J2888 Standards

For OSB, Call 901-300-4878

Prices subject to change without notice. Prices do not include applicable taxes, vehicles, tires, rims, installation or optional equipment as shown. Please do not return purchases to the store. For information regarding warranty, repair, or any questions or concerns, call 901-300-4878.

# AIR CONDITIONING

## A/C Service Tools

### A/C Condenser Fin Comb Straightener/Cleaner

SKU 466317 **8<sup>99</sup>**  
24526

- Clean and Straighten Condenser and Evaporator Coils
- Compact Design for Confined Spaces
- 6 Clearly Marked Combs: 8, 9, 10, 12, 14 and 15 Fins per Inch



### Valve Core Tool Set (2 Piece)

SKU 1209377 **9<sup>99</sup>**  
22589

- Designed for Removal and Installation of Schrader Style Valve Cores



### A/C Clutch Holding Tool

SKU 1392339 **15<sup>99</sup>**  
26550

- Holds Compressor Clutch in Place When Removing the Holding Bolt
- Adjustable Pins to Fit Various Compressor Clutches
- Compatible with Domestic and Import Vehicles



### A/C Clutch Hub Puller and Installer

SKU 1103539 **89<sup>99</sup>**  
37150

- Features All the Tools Necessary to Remove and Install Pressed on A/C Clutch Hubs on Many Domestic and Import Vehicles
- Includes Orifice Tube Extractor Tool Set

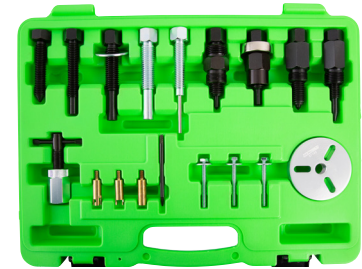

**OEM TOOLS**

## A/C Couplers

### R134a Manual Coupler Set

SKU 362980 **29<sup>99</sup>**  
24396

- All Metal Construction for Extra Durability
- 6-Ball Coupler for Secure Grip
- Includes Adapter for Use with R12 Hoses



### R134a High Side Manual Coupler

SKU 347267 **17<sup>99</sup>**  
24395

### R134a Low Side Manual Coupler

SKU 347266 **17<sup>99</sup>**  
24394

### 1234yf Manual Coupler Set with 134a Hose Adapters and Acme Adapter

SKU 1544682 **49<sup>99</sup>**  
25093

- Couplers Have 12 mm F Threads to Connect to 1234yf Hose Connections
- Two 12 mm M to 14 mm F Brass Adapters Included for Use with 134a Hoses
- Includes 1/2" M to 1/2" F Left Hand Acme Adapter



### R1234yf High-Side Coupler

SKU 1544684 **29<sup>99</sup>**  
25094

- Includes R134a Adapter

### R1234yf Low-Side Coupler

SKU 1544686 **29<sup>99</sup>**  
25095

- Includes R134a Adapter

**OEM TOOLS**

### R134a Extra Long Coupler

SKU 752517 **42<sup>99</sup>**  
24556

- Used on BMW E60 (2003-2009 5 Series) and Some Volvo Models
- Allows for A/C Service with No Radiator Removal



### R134a Refrigerant Tank Adapter

SKU 850565 **19<sup>99</sup>**  
24554

- Male Low-Side R134a to Female 1/2" ACME
- Attaches to Virgin Tank and Low-Side Service Coupler



### R1234yf Low Side Tank Adapter

SKU 1103204 **19<sup>99</sup>**  
25086

- Used to Fill Refrigerant from R1234yf Cylinders
- Attaches to Virgin Tank and Low Side Service Coupler
- This Fitting Does Not Have a Valve Core or Valve Core Depressor



### R1234yf Hose to Vacuum Pump Adapter Fitting 1/4" x 1/2"

SKU 600806 **19<sup>99</sup>**  
24509

- 1/4" SAE x 1/2" ACME Female LH Thread



## Valve Core Tools

### A/C Valve Core Tool

SKU 466314 **14<sup>99</sup>**  
24555

- Double-Ended Valve Core Tool to Service Both Standard and Large Bore R134a and R12 Cores

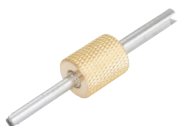

### No Gas Loss A/C Valve Core Remover/Installer

SKU 466321 **58<sup>99</sup>**  
24529

- Remove and Install Standard R134a Valve Cores without the Loss of Refrigerant
- Built-In Ball Valve Retains Charge and Allows Access to A/C System
- For 13 mm and 16 mm High and Low Service Ports
- Comes in Blow Mold Case



### Universal Valve Core Remover/Installer for R1234yf

SKU 1043686 **148<sup>99</sup>**  
MSC58490-YF

- Attaches to R1234yf Service Ports to Quickly and Easily Remove and Replace Valve Cores without the Loss of Refrigerant
- Ball Valve Design with Stainless Steel Ball Provides Smooth Movement and Durability
- Kit Covers 17 mm and 14 mm High and Low Side Service Ports
- Includes: Valve Assembly, High Side 17 mm Connector, Low Side 14 mm Connector, Standard Valve Core Shaft, GM Large Bore Valve Core Shaft and Eaton R134a/R1234yf High Side Valve Core Shaft



### Universal Valve Core Remover/Installer for R134a/R12

SKU 1142576 **241<sup>99</sup>**  
MSC58490

- Kit Covers All R12 and R134a System Valve Cores for Standard, JRA, Eaton and GM Large Bore
- Includes: Valve Assembly, R134a High Side 16 mm Connector, R134a Low Side 13 mm Connector, 1/4" FL Swivel Connector, Adapter 1/4"-M x 3/16"-F High Side GM/Ford, Adapter 1/4"-M x 1/8"-F High Side Ford and Blow Mold Case

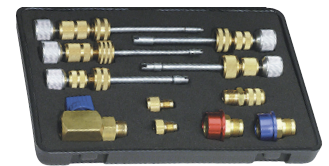

**Mastercool**  
"World Class Quality"

**Mastercool**  
"World Class Quality"

## SpotGun® Jr.

### SpotGun® Jr. Univ. Oil/UV Dye Kit for R134a/R1234yf - 1 Oz.

SKU 1368623 **229<sup>99</sup>**  
UVU390100

- Works with Both R134a and R1234yf Refrigerant Systems
- 4 Universal Oil Cartridges (1 Oz.)
- 2 ExtenDye™ Cartridges (1 Oz.)
- 2 LeakGuard™ OneShot Cartridges (1 Oz.)
- 2 Low-Side Service Adapter Hoses and R134a/R1234yf Couplers



### SpotGun® Jr. Univ. Oil/UV Dye Kit for R134a/R1234yf - 1 Oz. with UV Lite

SKU 1400039 **299<sup>99</sup>**  
UVU390200

- Works with Both R134a and R1234yf Refrigerant Systems
- Includes: UV Phazer (AAA) UV Lite and UV Enhancing Glasses
- 4 Universal A/C Oil (1 Oz.)
- 2 ExtenDye™ Cartridges (1 Oz.)
- 2 LeakGuard™ OneShot Cartridges (1 Oz.)



### A/C ExtenDye™ Cartridge

- SAE J2297 Certified Super Concentrated UV Dye
- Works in R134a, R1234yf Systems and is Hybrid Safe
- Contains Friction Modifier to Increase Lubricity and Decrease Friction
- Contains Antioxidant to Prolong Oil Life
- Anti-Wear Additive for Better Wear Resistance
- Works with SpotGun® Jr. Injection System

### A/C ExtenDye™ Cartridge 1 Oz. (4 Pack)

SKU 1362004  
UVU399020A

**59<sup>99</sup>**



### A/C ExtenDye™ Cartridge .25 Oz. (6 Pack)

SKU OSB  
UVU399006A

**34<sup>99</sup>**



### Universal PAG 46 Oil for R134a - 1 Oz. Cartridge (12 Pack)

SKU OSB **99<sup>99</sup>**  
UVU399046

- OEM Approved
- Works with SpotGun® Jr. Injection System
- Formulated to Work with R1234yf, R134a and Hybrid Safe
- Sealed Cartridge Assures Clean Oil Delivered to Vehicle A/C System
- Injection System Measures the Correct Dosage



### Universal PAG 46 Oil R1234yf - 1 Oz. Cartridge (4 Pack)

SKU OSB  
UVU399046YF

**54<sup>99</sup>**

To Confirm Price, Availability and Ordering Instructions on OSB, Call 901-300-4878

## SpotGun®

### SpotGun® Univ. Oil/Dye Kit for R134a/R1234yf - 8 Oz. without UV Lite

SKU OSB **199<sup>99</sup>**  
UVU490100

- Works with Both R134a and R1234yf Refrigerant Systems
- 1 Universal Oil Cartridge (8 Oz.)
- 1 ExtenDye™ Cartridge (8 Oz.)
- Service Maintenance Stickers
- 2 Low-Side Service Adapter Hoses and R134a/R1234yf Couplers



### SpotGun® Univ. Oil/Dye Kit for R134a/R1234yf - 8 Oz. with UV Lite

SKU OSB **259<sup>99</sup>**  
UVU490200

- Works with Both R134a and R1234yf Refrigerant Systems
- 1 Universal Oil Cartridge (8 Oz.)
- 1 ExtenDye™ Cartridge (8 Oz.)
- UV Phazer™ Black (AAA Batteries Included) UV Enhancing Glasses



### A/C ExtenDye™ Cartridge - 8 Oz.

SKU OSB **79<sup>99</sup>**  
UVU499108A

- Works in R134a, R1234yf Systems and is Hybrid Safe
- Contains Friction Modifier
- Contains Antioxidant to Prolong Oil Life
- Fits Competitive Guns



## Mastercool

### Professional UV Leak Detection Kit with 12V/50W UV Light

SKU 290041 **96<sup>99</sup>**  
MSC53351

- 12 Volt/50 Watt UV Leak Detector
- 1 Oz. Coolant Dye, 1 Oz. Oil/ATF/Fuel Dye, Dye Remover
- Mini Dye Injector (10 Applications of Universal A/C Dye) Compatible with R134a and R12 Adapter
- UV Enhancing Safety Glasses
- 12 Service Labels



### Universal Concentrated Dye Cartridge 1 Oz. (5 Pack)

SKU 505040 **80<sup>99</sup>**  
MSC53810-5

- 5 Pack of Dye for 53585 Leak Detector Kit
- 10 Applications per Bottle



# AIR CONDITIONING

## UV Leak Detection Lights

### 13.4" Multi-Use Rechargeable Diagnostic Under-the-Hood Work Light

SKU 591153 24609 **129<sup>99</sup>**

- 5 Hr. Run Time on High



OEM TOOLS

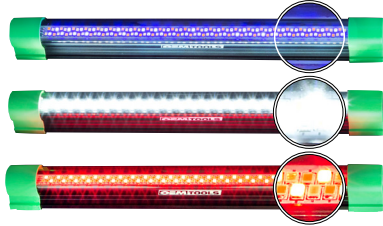

UV Leak Dye Detection Light

400 Lumens Super Bright Work Light

Yellow Smoke Detection Light

### Rechargeable UV Flashlight

SKU 1544660 MSC53518UV **111<sup>99</sup>**

- High-Intensity LED Ensures Superior Illumination for Accurate Leak Detection
- 2W Lamp Power: Provides Powerful Performance In a Compact Design
- UV Intensity: 154–170  $\mu\text{W}/\text{cm}^2$ , Comparable to a 50-Watt UV Flashlight
- UV Wavelength: Operates At 390–400 Nm for Optimal Detection
- Rechargeable Battery: Delivers 3 to 5 Hours of Continuous Use
- Backup Power Option: Includes Holder and 3 AAA Batteries



Mastercool  
"World Class Quality"

### UV Phazer Professional 395nm Leak Detection Light

- Adjustable Zoom Lens Allows for Focusing Light Intensity In a Smaller/Larger Area for Precision Viewing
- Rechargeable Li-ion Battery

#### Black

SKU 1405963 UVUEW40395 **109<sup>99</sup>**

- High Output True UV LED Light
- Precise, True UV Wavelength and Bandwidth to Optimize the Fluorescence of UV Dyes
- Max. Run Time: 4 Hrs.



#### NEO

SKU 1400042 UVUEW50395 **164<sup>99</sup>**

- UV Dye Shines Brighter with the Phazer Neo Than Any Other UV Light
- Water Resistant
- Max. Run Time: 5 Hrs.



VIEW

### UV Leak Detection Light and Glasses

SKU 213144 24516 **34<sup>99</sup>**

- Compact UV Leak Detection Pen Light
- Can Be Used with All Types of UV Leak Detection Dyes
- Yellow Lens Protective Glasses Enhance Visibility of Leaks



OEM TOOLS



2 AA

### Magnifying Glass with 5 LED and 1 UV Light

SKU 191688 25465 **23<sup>99</sup>**

- Compact Magnifier with 5 LED Lights and a Super Bright UV Light
- UV Light Detects Dyes



OEM TOOLS

## Refillable Injectors

### In-Line Dye and Oil Injector

SKU 466322 24532 **43<sup>99</sup>**

- Add Up to 2 Oz. of Oil or Dye to a System Under Vacuum or While Adding Refrigerant
- 1/2" ACME Fittings to Fit Most R134a Systems
- Use with UVU499008A A/C ExtenDye™ Bottle (8 Oz.)



OEM TOOLS

### R12 and R134a Hand Turn Dye Injector

SKU 466320 24528 **109<sup>99</sup>**

- Injects Dye or Oil into R12 or R134a Systems
- Refillable, Capacity: 2 Oz.
- Includes: R134a Quick Coupler
- Use with UVU499008A A/C ExtenDye™ Bottle (8 Oz.)



OEM TOOLS

## Pourable Dyes

### A/C ExtenDye™ Bottle - 8 Oz.

SKU 1392333 UVU499008A **59<sup>99</sup>**

- SAE J2297 Certified Super Concentrated UV Dye
- Works in R134a, R1234yf Systems and is Hybrid Safe
- Contains Friction Modifier to Increase Lubricity and Decrease Friction
- Contains Antioxidant to Prolong Oil Life
- Anti-Wear Additive for Better Wear Resistance



VIEW

### R1234yf Hand Turn Oil and Dye Injector

SKU 213158 24517 **109<sup>99</sup>**

- Easy to Operate Hand Turn Injection
- Durable Aluminum Construction with Laser Etched Filling Guide
- Includes: R1234yf System Coupler
- 2 Oz. (60 mL) Capacity
- Use with UVU499008A A/C ExtenDye™ Bottle (8 Oz.)



OEM TOOLS

### R134a and R1234yf Oil and Dye Injector Kit

SKU OSB 24699 **134<sup>99</sup>**

- Great Accessory for Hybrid AC Recovery Machines
- Injects Dye or Oil into R1234yf or R134a Systems
- Easy Twist Injection Allows for Precise Control
- Includes: 2 Injectors and Adapters to Fit Most Automotive AC Systems
- Heavy Duty Aluminum Construction



For OSB, Call 901-300-4878

OEM TOOLS

### Refillable Universal Dye Injector for R1234yf

SKU 764999 MSC53123-YF **164<sup>99</sup>**

- Heavy Duty Aluminum Construction
- Injects Dye or Oil into R1234yf Systems
- Refillable, Any Dye or Oil Can Be Used
- Easy Twist Injection System
- Precise Injection Control



Mastercool  
"World Class Quality"

### Multi-Purpose Dye

SKU 1392316 UVUB483206 **49<sup>99</sup>**

- Pinpoint Leaks in Engine Oil, Transmission, Hydraulic, Power Steering, Gasoline and Diesel Fuel Systems



Prices subject to change without notice. Prices do not include applicable taxes, vehicles, tires, rims, installation or optional equipment as shown. Please do not return purchases to the store. For information regarding warranty, repair, or any questions or concerns, call 901-300-4878.

# AIR CONDITIONING

TO ORDER, contact your Commercial Sales Manager or go to [AutoZonePro.com](http://AutoZonePro.com)

AIR CONDITIONING

## Orifice Tube

OEM TOOLS®

### 26 Piece Master Orifice Tube Assortment

SKU 851868 **30<sup>99</sup>**  
24564

- Covers Most Vehicles That Require Air Conditioning Orifice Tubes
- Includes: Chrysler (Orange, Purple T-Top), Ford (Black, Blue, Brown, Green, Red), GM (Black T-Top, White, Yellow), Jeep (Green - White) and Volvo (Yellow)



## A/C O-Ring Assortment

HARDWARE  
MACHINERY

### 270 Piece A/C O-Ring Kit

SKU 271196 **9<sup>99</sup>**  
68141

- Great O-Ring Set for Most Automotive and Refrigerant Applications

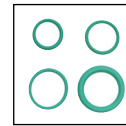

Kit Contains 270 O-Rings in a Variety of SAE Sizes



## Digital Scales

### Digital Refrigerant Scale (240 Lb. Capacity)

SKU 752521 **289<sup>99</sup>**  
24560

- High-Visibility .75" x 2.5" LCD Backlit Display
- 3 Units of Measure: Kg/Oz./Lb.
- Automatic Shut-Off After 10 Minutes, Backlight Will Shut Off After 3 Minutes
- Fully Enclosed and Removable Metal Scale Platform Enables Use of Product in or Out of the Protective Case



### Black Series Electronic Charging Scale with Bluetooth

SKU 290029 **309<sup>99</sup>**  
MSC98210-BL

- Includes: Bluetooth Wireless Technology
- Capacity: 243 Lb.
- Accuracy:  $\leq \pm 0.05\%$  of Reading
- Resolution: 0.05 Lb./0.5 Oz./0.01 kg
- Rugged, Non-Slip Platform



Mastercool®  
"World Class Quality"

## A/C Flush

### A/C Flush Machine

SKU OSB  
CPSAFM100

**1,799<sup>99</sup>**

- Air Operated 8' Hoses to Reach Any System
- Forward or Reverse Flush without Changing Hoses
- 2-1/2 Gallon Capacity Tank for Use on Cars and Buses
- Universal Couplers Allows Connection to Most Types of Connections
- Clear Filter Bowl Allows You to See What is Coming Out of the System with a Cleanable Filter



cps®

For OSB, Call 901-300-4878

### MASTERCLEANSE A/C Flush Machine

SKU OSB **879<sup>99</sup>**  
MSC69900

- Designed to Flush All HVAC/R and Automotive Systems
- Pump Power: 0.4 HP; Flow Rate: 4 Gal/Min.
- Stainless Steel Ball Valve Controls
- 1/4" SAE Connection
- Pump Equipped with Mechanical Seal and PTFE Gasket
- 110 VAC



Mastercool®  
"World Class Quality"

For OSB, Call 901-300-4878

### Adapter Kit

SKU 481575 **144<sup>99</sup>**  
MSC69925

- Isolates A/C System Components for Closed Loop Flushing
- Flush Individual Components without Removing Them from the Vehicle
- Install Adapters on A/C Line Ends to Allow Attachment of Flushing Equipment



### A/C Flush Kit

SKU 1103579 **84<sup>99</sup>**  
37377

- Uses Shop Air to Pressurize the Solvent to Thoroughly Clean the System
- Simple, Effective and Easy to Use
- Attached Nozzle Directs the Solvent without Sprayback
- Includes: Canister, Hose, Blowgun, Rubber Tip and Cylinder Cap
- Solvent Purchased Separately



OEM TOOLS®

### A/C Flush Solvent

#### Bottle (32 Oz.)

SKU 695650 **18<sup>99</sup>**  
MSC91049-32

#### 1 Gallon

SKU 695653 **55<sup>99</sup>**  
MSC91049-128



Mastercool®  
"World Class Quality"

MSC91049-32

MSC91049-128

Prices subject to change without notice. Prices do not include applicable taxes, vehicles, tires, rims, installation or optional equipment as shown. Please do not return purchases to the store. For information regarding warranty, repair, or any questions or concerns, call 901-300-4878.

AZG0226

# AIR CONDITIONING

## A/C Hose and Line Repair

OEM TOOLS®

### Heavy Duty Ratcheting Hose Cutter

SKU 466311 **19<sup>99</sup>**  
24522

- Smooth Action and High Quality Blade Provide Quick, Clean and Accurate Cuts
- Ratcheting Action Makes it Faster and Easier to Use than Other Cutters
- Cuts Rubber Hose and PVC Up to 1-1/2" OD
- Wide Hooked Jaws Hold Tubing Securely



### Ratcheting Tubing Cutter

SKU 466309 **34<sup>99</sup>**  
24520

- Ratcheting Action is Ideal Where Space is Limited
- Cuts 1/4" to 7/8" Tubing
- Spare Cutting Wheel Included



OEM TOOLS®

## Thermometers

OEM TOOLS®

### Thermal Imaging Camera

SKU 213193 **439<sup>99</sup>**  
24552

- Temperature Range: -4°F to 1,202°F (-20°C to 650°C), Selectable Temperature (C or F)
- Captures Thermal Images and Saves to MicroSD Card (Not Included)
- 3 Selectable Color Palettes
- 1.8" LCD Color Display
- Includes: Storage Pouch and Mini USB Cable



### Manual Style A/C Hose Crimper, Bench or Vise Mounted

SKU 290028 **359<sup>99</sup>**  
MSC71550

- Manual Style A/C Hose Crimper
- Mount to Bench Using Holding Fixture or Place in Vise
- Includes: 71500 - 001 Yoke Assembly, 71550 - 002 Arbor Assembly, 71550 - 003 Holding Fixture Assembly, 71500 - 6 Die Set - #6 (5/16"), 71500 - 8 Die Set - #8 (13/32"), 71500 - 10 Die Set - #10 (1/2"), 71500 - 12 Die Set - #12 (5/8") and 71500-PB Custom Mold Box Carrying Case

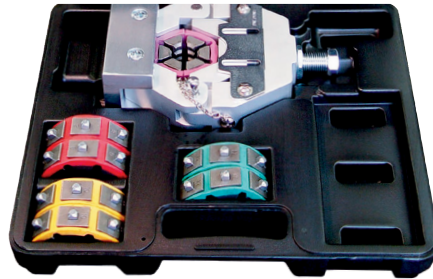

Mastercool®  
World Class Quality™

### Non-Contact Infrared Thermometer

SKU 951642 **44<sup>99</sup>**  
25245

- Point-and-Click Non-Contact Thermometer Uses a Laser Pointer to Give Precise Temperature Readings Ranging from -58°F to 716°F (-50°C to 380°C)
- Laser Pointer Identifies the Spot to Be Measured and Provides Accurate Temperature Measurements from a 12:1 Distance-to-Spot Ratio (Emissivity 0.95 Preset)
- Lightweight and Easy to Operate with an LCD Backlit Display That Makes it Effective Even in Low Light Situations
- Auto Power-Off Feature Conserves Battery Power by Shutting Thermometer Off After 7 Seconds of Non-Use
- 9V Battery Included (Typical Battery Life: 22 Hours in Non-Laser Mode, 12 Hours in Laser Mode)



## AirSept® Line Repair

**SAVE TIME & MONEY!**

CERTIFIED  
LEAK-FREE

UP TO 2,600 psi

**FIX or TERMINATE a Line in 5 MINUTES!**

OE-APPROVED REPAIR SOLUTION INSTALLS IN MINUTES, NO SPECIAL TOOLS, NO GLUE

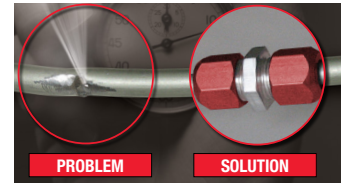

AIRSEPT  
PART SMART

### Line Terminator SAE (5 Pack)

SKU 504122 **109<sup>99</sup>**  
AIR76526

- Quickly and Effectively Blocks A/C Lines at the Damage Point or at the Front System "Y"
- Block Off Leaking Rear Evaporators and Failed System Components
- Include One Each: 5/16", 3/8", 1/2", 5/8" and 3/4" SAE Kits



### Line Terminator SAE/Metric (10 Pack)

SKU 504124 **199<sup>99</sup>**  
AIR76530

- Quickly and Effectively Blocks A/C Lines at the Damage Point or at the Front System "Y"
- Block Off Leaking Rear Evaporators and Failed System Components
- Includes: One Each: 5/16", 3/8", 1/2", 5/8", 3/4", 8 mm, 10 mm, 12 mm, 15 mm and 16 mm

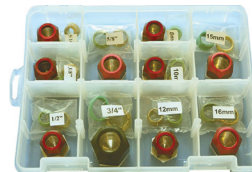

### Line Splice Straight SAE/Metric (10 Pack)

SKU 504103 **284<sup>99</sup>**  
AIR76051

- Includes: One Each: 5/16", 3/8", 1/2", 5/8", 3/4", 8 mm, 10 mm, 12 mm, 15 mm and 16 mm



### Line Terminator Rear A/C Blockoff Kits

- Quickly and Effectively Blocks A/C Lines at the Damage Point or at the Front System "Y"
- Block-Off Leaking Rear Evaporators and Failed System Components
- Help Maximize Front A/C Performance
- Eliminate Refrigerant and Oil Pooling in Rear A/C Lines



SKU	Part #	Size	Price
504149	AIR76502	3/8" Line	<b>26.99</b>
504146	AIR76501	1/2" Line	<b>26.99</b>
504150	AIR76503	5/16" Line	<b>26.99</b>
504152	AIR76504	5/8" Line	<b>30.99</b>
504154	AIR76505	3/4" Line	<b>35.99</b>
329221	AIR77508	8 mm OD Line	<b>26.99</b>
329219	AIR77510	10 mm OD Line	<b>26.99</b>
329231	AIR77515	15 mm OD Line	<b>30.99</b>
329230	AIR77516	16 mm OD Line	<b>30.99</b>

### Line Splice Straight Repair Kit

- High-Tech Anti-Vibration Tension Ring Ensures Durability in Tough Automotive Applications
- HNBR Seal Sleeve Dramatically Expands the Sealing Surface Area
- Burst Tested to 2,600 psi



SKU	Part #	Size	Price
504140	AIR76003	5/16" Line	<b>35.99</b>
504138	AIR76002	3/8" Line	<b>35.99</b>
504136	AIR76001	1/2" Line	<b>35.99</b>
504143	AIR76011	5/8" Line	<b>44.99</b>
504132	AIR77008	8 mm Line	<b>35.99</b>
504155	AIR77010	10 mm Line	<b>35.99</b>

### Smart Splice™ Line to Hose

- Leak-Proof Line Splice™ Technology on the Metal Side of the Connection
- Superior Hose Crimp Technology on the Rubber Side
- Also Works for Heater and Coolant Lines
- Install in 5 Minutes



SKU	Part #	Size	Price
504125	AIR76701	1/2" Line to #8 Hose	<b>35.99</b>

# ALLDATA®

ALLDATA REPAIR® & ALLDATA COLLISION® + ALLDATA ESTIMATOR

## Fast-Track Estimates & Order AutoZone® Parts

**NEW!**  
ALLDATA ESTIMATOR  
NOW INCLUDED  
WITH YOUR  
SUBSCRIPTION

- Quickly create professional, compliant estimates
- Easily add parts & labor costs directly from ALLDATA Repair or ALLDATA Collision
- Store customer and vehicle data, including custom jobs
- Customize the estimate with your shop's logo
- Order AutoZone parts directly from the catalog

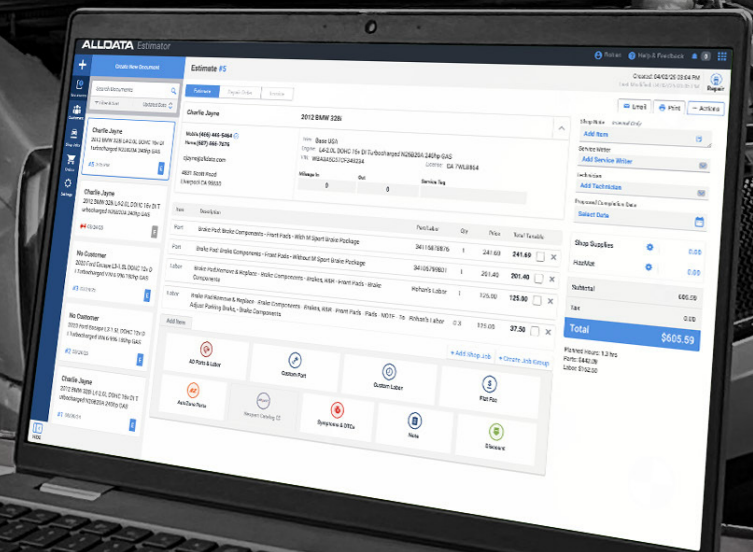

# (888) 726-3211

For our latest pricing and promotions visit

# ALLDATA.com

©2016 ALLDATA LLC. ALLDATA, Automotive Intelligence, ALLDATA Repair, ALLDATA Collision, ALLDATA Shop Manager, ALLDATA Tech-Assist and ALLDATA Mobile are registered trademarks and ALLDATA Manage, ALLDATA Community and ALLDATA Estimator are marks of ALLDATA LLC. AutoZone is a registered trademark of AutoZone IP LLC. All other marks are property of their respective owners.

# DIAGNOSTICS

## TopDon

### 6" Bluetooth Scan Tool with Service Functions and CAN-FD

SKU **OSB**  
**TPDAD800BT2** **299<sup>99</sup>**

- FCA SGW Support
- 28+ Special Services for Your Productive Days
- Wider Coverage, Faster Solutions
- Cut the Cord, Work Without Limits
- All Systems Covered, All Issues Addressed
- Real-Time Performance Tracking with Live Data
- Effortless Organization, Ergonomic Excellence
- Identify, Record, and Share with Ease
- Take Advantage of the Feedback Feature to Communicate Any Issues You Encounter



For OSB, Call 901-300-4878

### T-Ninja Pro Key Programming Via OBD2

SKU **1340225**  
**TPDNINJAPRO** **559<sup>99</sup>**

- Pin Reading and Key Learning
- Remote Control Learning
- Deletes Keys
- All Keys Lost
- Reads and Clears Fault Codes
- Supports Wireless and Wired Dual Connectivity



**TOPDON**<sup>®</sup>

### Phoenix Smart Diagnostic System

SKU **1331482**  
**TPDPXSMART** **2,259<sup>99</sup>**

- Android Based OE-Level Coverage
- 10.1" HD Touch Screen
- TOPOLOGY Feature for Enhanced Diagnostics
- SmartLink VCI - Adds CanFD, DoIP, J2534, RP1210
- Codes/Data/Bi-Directional/Special Functions/Coding/Programming



### Phoenix Max Diagnostic System

SKU **1331492**  
**TPDPXMAX** **4,159<sup>99</sup>**

- Includes A 4-Channel Oscilloscope
- Supports Cloud-Based Programming For 9+ Brands, Including: Mercedes-Benz, BMW, Audi, Volkswagen/Skoda/Seat, Porsche, Jaguar/Land Rover, Nissan, Subaru and Renault
- Supports 9V to 24V Vehicle Models, Configuring Both Passenger Cars and Heavy Trucks
- Heavy Duty Housing with IP65 Standards
- Auto VIN Technology Automatically Uses the Right Diagnostic Software After Identifying the Vehicle Through its VIN



### UltraDiag 2-in-1 Diagnostic Scanner and Key Programmer

SKU **1368629**  
**TPDULTRADIAG** **799<sup>99</sup>**

- Full-System Diagnostics
- 8 Reset Functions: Oil, Throttle Adaptation, EPB, Steering Angle, DPF Regeneration, ABS Bleeding, BMS and Airbag
- Key Programming Functions: Number of Keys, PIN Reading, Key Learning, Remote Control Learning, Delete Keys and All Keys Lost



### Transponder and Remote Tester Tool

SKU **OSB**  
**TPDT-DARTS** **40<sup>99</sup>**

- Allows Either USB or Battery Powered Function
- Supports Transponder Chips
- Supports 100+ Transponder Chips
- Includes: Quick Guide and a USB Type-C Cable



For OSB, Call 901-300-4878

### Heavy-Duty Non-16 Pin Cable Kit

SKU **OSB**  
**TPDHDCKIT** **399<sup>99</sup>**

- Includes: OBD-9, OBD-6, OBD-16, IVECO-38, IVECO-30, BENZ-14, MAN-12, MAN-37, ISUZU-3, ISUZU-20, RENAULT-12, VOLVO-8PIN, and CAT-9



For OSB, Call 901-300-4878

## SHARED SERVICE FUNCTIONS

- |                                 |   |                             |                                 |
|---------------------------------|---|-----------------------------|---------------------------------|
| OIL RESET                       | THROTTLE                                  | AIRBAG RESET                | A/C                             |
| EPB - ELECTRONIC PARKING BRAKE  | ABS/SRS                                   | CLUTCH                      | RAIN/LIGHT SENSOR               |
| BMS - BATTERY MANAGEMENT SYSTEM | VGT LEARN                                 | A/F SETTING                 | RESET CONTROL UNIT              |
| SAS - STEERING ANGLE SENSOR     | RELATIVE COMPRESSION WINDOW / DOOR / ROOF | RESOLVER SENSOR CALIBRATION | CCS/ACC VIN                     |
| IMMO KEYS - IMMOBILIZER & KEYS  | SEATS                                     | AUTOMATIC START/STOP        | COOLANT/REFRIGERANT CHANGE      |
| BRAKE BLEED                     | ODOMETER                                  | ELECTRONIC WATER PUMP START | SUNROOF INITIALIZATION          |
| DPF - DIESEL PARTICULATE FILTER | LANGUAGE CHANGE                           | EGR                         | TEC LEARN                       |
| INJECTOR SUSPENSION             | HEADLAMP                                  | FRM RESET                   | HV DE-ENERGIZATION/ENERGIZATION |
|                                 | CHG TIRE SIZE                             | TRANSPORT MODE              | ALL SYSTEM AUTO-SCAN            |
|                                 | SPEED & PTO                               | HV BATTERY ACC              |                                 |
|                                 | CYLINDER                                  |                             |                                 |
|                                 | TRANS ADAPTION                            |                             |                                 |



MaxiCheck<sup>®</sup> MX900  
 SKU #1369200 | Part #MX900



MaxiTPMS<sup>®</sup> TS900  
 SKU #1337325 | Part #TS900



MaxiBAS<sup>®</sup> BT609  
 SKU #1125832 | Part #BT609

	MAXICHECK MX900	MAXITPMS TS900	MAXIBAS BT609
OPERATING SYSTEM	ANDROID 11	ANDROID 11	ANDROID 9
SOFTWARE UPDATES	1 YEAR FREE	1 YEAR FREE	1 YEAR FREE
AUTOMATIC DETECTIONS	AUTO-VIN/SCANVIN	AUTO-VIN/SCANVIN	AUTO-VIN/SCANVIN
VEHICLE COVERAGE	US, ASIAN & EUROPEAN 1996+	US, ASIAN & EUROPEAN 1996+	US, ASIAN & EUROPEAN 1996+
OBDDII TEST MODES	PERFORM BI-DIRECTIONAL ACTIVE TESTS AND SPECIAL FUNCTIONS	PERFORM BI-DIRECTIONAL ACTIVE TESTS AND SPECIAL FUNCTIONS	PERFORM BI-DIRECTIONAL ACTIVE TESTS AND SPECIAL FUNCTIONS
DIAGNOSTICS & SERVICE	ALL SYSTEMS / 40+ SERVICES	ALL SYSTEMS / 40+ SERVICES	ALL SYSTEMS / 40+ SERVICES
VEHICLE CONNECTIVITY	CORDED	BLUETOOTH VCI	BLUETOOTH VCI
TPMS DIAGNOSTICS	-	INCLUDED WITH ENHANCED TPMS STATUS SCREEN	-
TPMS SENSOR COMPATIBILITY	-	AUTEL BLE SENSOR FOR TESLA + PROGRAM AUTEL MX-SENSOR 1-SENSORS	-
BATTERY TESTING	-	-	INCLUDED

CALL FOR PRICE

**AUTEL**<sup>®</sup>

## Smoke Leak Detectors

### Smoke Pro® Total Tech Smoke Machine

SKU OSB  
RED95-0050 **1,199<sup>99</sup>**

- Pinpoint Leaks as Small as 0.010"
- Rechargeable LED Inspection Light
- Field Replaceable Smoke Hose
- Refined Flow Meter Callout Heavy Duty Flow Control Valve
- Includes: Easy Intake and Easy Connect



For OSB, Call  
901-300-4878

REDLINE  
DETECTION.COM



Made in USA

### Smoke Pro Air™

SKU 1340239  
RED95-0075 **1,399<sup>99</sup>**

- Ideal for Performing Diagnostics on the Evap Systems of Naturally-Aspirated Vehicles
- Features an Onboard Micro Air Compressor for Total Portability and Includes All Needed Accessories
- Uses OEM-Approved Fluid to Produce a Visual Vapor That is Free of Dyes and Contaminants
- Detects Leaks as Small as 0.010" and Performs Air Leak Decay Test



REDLINE  
DETECTION.COM



Made in USA

### ReadySmoke™ Leak Detector

SKU 744010  
RED95-0400 **749<sup>99</sup>**

- Pinpoint Intake, Exhaust and Other EVAP Leaks In Minutes
- Flow Meter Identifies Minute Leaks at and Below .010" in Diameter
- Easy Fill Dipstick Style Fluid Port
- Includes: (2) 2 Oz. OEM-Approved Vapor Producing Fluid, EVAP Service Tool Kit, Halogen Inspection Light, Cap Plug Kit, Standard Cone Adapter and Storage Case



REDLINE  
DETECTION.COM



Made in USA

### Intake Inflatable Block Off Bladder

OEM TOOLS®

SKU 598274  
24536 **134<sup>99</sup>**

- Conforms to Any Shape
- Intake/Exhaust: Square, Round, Oval or Rectangular
- Works with Most Automobiles and Light, Medium and Heavy Duty Trucks
- Replacement Bladder Available



Use with All  
Smoke Machines

### EasyConnect® Test Kit

SKU 1189091  
RED96-0190 **109<sup>99</sup>**

- Forms a Complete Seal for Effective Leak Testing without Disturbing Other Components
- Comes in a Compact and Durable Storage Case
- Compatible with Any Smoke Machine
- Includes: 4 Different Sized Adapters with 4 Add-On Components



REDLINE  
DETECTION.COM



Made in USA

### Easy INTAKE™

SKU 696477  
RED95-0082 **169<sup>99</sup>**

- Compatible with Any Smoke Machine
- Block Off Bladder Conforms to Any Shape Intake/Exhaust



REDLINE  
DETECTION.COM



Made in USA

### Smoke Producing Fluid (8 Oz.)

SKU 802333  
RED96-0039 **29<sup>99</sup>**

- Contains No Dye or Other Contaminants
- Works in Most EVAP Smoke Machines
- Uses OEM-Approved Fluid to Produce a Visual Vapor That is Free of Dyes and Contaminants



REDLINE  
DETECTION.COM



Made in USA

### EasyEVAP™ Universal Filler Neck Connector

SKU 343405  
RED95-0030 **124<sup>99</sup>**

- Compatible with Any Smoke Machine and Removes Cleanly from the Gas Cap
- Essential Tool for Late Model Cars with Fuel Tank Rollover Valves



REDLINE  
DETECTION.COM



Made in USA

### Digital Dual Smoke Machine

SKU OSB  
MSC43066 **1,649<sup>99</sup>**

- High-Precision Gas Pressure Sensor Ensures Accurate Data
- 3 Built-In High-Power Air Pumps, Offers Faster and Thicker Smoke Generation
- Pressure Regulated at 0.44-0.5 psi for Safe EVAP Testing, Maximum Out 20 psi for High Pressure Testing
- Accessories Include: Full Set of Block Off Caps, Schrader Valve Remover/Installer, Service Port Adapter Hose, 2 Oz. Smoke Producing Fluid and Bladder for Intake Testing



For OSB, Call  
901-300-4878

Mastercool®  
"World Class Quality"

### Evap Diagnostic Smoke Machine

SKU OSB  
MSC43060EV **1,049<sup>99</sup>**

- Multiple Options for Smoke Injection Include Built-In Internal Compressor, Shop Air and Inert Gases
- Pressure Decay Gauge 0-30" H2O (70 mbar)
- Flow Meter: 0 to 0.040" (0 to 1.0 mm)
- Input Pressure: Max. 100 psi (8.2 bar)
- Built-In Pressure Regulated at 0.5 psi



For OSB, Call  
901-300-4878

Mastercool®  
"World Class Quality"

# DIAGNOSTICS

## Diagnostics

### Compression Tester Gauge Set

SKU 1103601  
37138 **46<sup>99</sup>**

- Use to Test Compression 0 to 300 psi on 14 mm and 18 mm Spark Plug Ports and Determine Engine Mechanical Condition

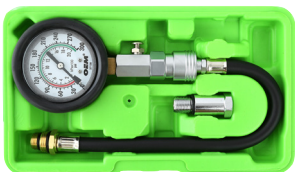

### 8 Piece Noid Light Set

SKU 1103589  
37161 **29<sup>99</sup>**

- Includes: GM TBI, GM SCPI, GM PFI, Ford TBI, GEO TBI, Bosch PFI, Bosch Type 2 and GM Multec 2
- See-Through Design to Check Electrical Pulses

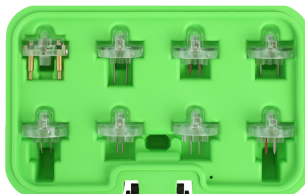

### Automotive Tune-Up and Brake Bleed Kit

SKU 466495  
25138 **39<sup>99</sup>**

- Includes Components to Diagnose and Service Vacuum and Pressure-Related Systems
- Modern System Coverage – Tests Vacuum Lines, Reservoirs, Actuators, and HVAC Controls on Today's Vehicles
- Enables One-Person Brake Bleeding with Minimal Spills



### Exhaust Back Pressure Tester/Gauge

SKU 1103604  
37263 **69<sup>99</sup>**

- Oxygen Sensor Adapter is M12 and M18 Thread
- 6' Hose Allows User to Test from Driver's Seat
- Test for Restricted Exhaust Systems

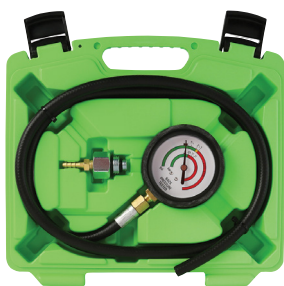

### Oil Pressure Gauge Set

SKU OSB  
27262 **54<sup>99</sup>**

- For Use on Diesel and Gasoline Engines
- Includes Standard and Metric Adapters Found on Most Cars and Trucks
- 2-1/2" Easy-to-Read Gauge with Protective Boot
- Range: 0-100 psi, 0 to 7 Bar



For OSB, Call 901-300-4878



## AUTEL MAXISYS ULTRA S2

ANOTHER LEAP FORWARD



6-in-1 VCMII

MaxiSYS® MSULTRA S2  
SKU #1540763 | Part #MSULTRAS2

NEW



MaxiSYS® MS919 S2  
SKU #1606641 | Part #MS919S2

NEW



MaxiSYS® MS909 S2  
SKU #1606642 | Part #MS909S2

INCLUDE 5 YEARS SOFTWARE COVERAGE



MaxiCheck® MX900  
SKU #1661670  
Part #MX9005YR  
• Read & Erase Codes  
• Bidirectional Active Tests and Special Functions  
• 40+ Function Service Menu



MaxiSYS® MS909CV  
SKU #1174556 | Part #MS909CV  
• For Class 1-8 Commercial Vehicles  
• Topology Mapping on Select Models  
• Engine Coverage for Construction & Agricultural Vehicles



MaxiSYS® MS906 MAX  
SKU #1661671 | Part #MS906MAX5YR  
• 10.1" professional diagnostics and service tablet  
• Perform all-systems diagnostics  
• Bi-directional Active Tests & Special Functions



MaxiIM® IM608PROIIPKA  
SKU #1336440  
Part #IM608PROIIPKA  
• IMMO and Key Programming Bundle  
• Program IMMO & Keys for U.S., Asian, and European Vehicles  
• IM608PROIIPKA Tablet, XP400Pro, Wireless JVCI, IMKPA Key Programming Adapter Kit



SCAN OR VISIT  
AUTEL.US/ULTRA-S2

Built on its award-winning predecessor, the Autel MaxiSYS Ultra, the Ultra S2 sets a new benchmark for efficiency and accuracy with upgraded hardware and advanced diagnostic features that deliver near OEM-level diagnostics and service capability.

### Data-Driven Diagnostics with Enhanced PID Analysis

**Data Visualization:** Enhanced graphing capability to visualize multiple parameters to identify the relationship between PIDs and pinpoint system anomalies.

**Live Data Fusion:** Record and compare value changes across multiple systems.

**Parameter Grouping:** Multi-PID selection for analyzing related parameters simultaneously. Ideal for engine fault and performance and emissions troubleshooting.

**Reference Sampling:** Record, store, and review selected PIDs for pre- and post-repair comparison that will flag min, max, and average.

**Real-Time, Split-Screen Analysis:** Access the oscilloscope directly from the current Live Data screen. (MSULTRAS2 & MS919S2 ONLY)



MaxiVIDEO® MV480  
SKU #1137680 | Part #MV480  
• Record/Playback Images & Videos  
• 4.1" Color LCD Display  
• Dual Front and Side Cameras for Wider Viewing Angle

MaxiVIDEO® MV460  
SKU #1089243 | Part #MV460  
• 3.5" Color LCD Display

### AutoLINK® AL549 | SKU #789375 | Part #AL549

- Universal OBD II and ABS Code Reader
- Read & Erase Codes, View Freeze Frame and Live Data
- Supports all 10 Modes of OBD II
- Compatible with U.S., Asian, and European vehicles, 1996 & Newer



### MaxiDIAG® MD909 Pro

- SKU #1597905 | Part #MD909PRO
- All Systems diagnostic tablet for U.S., Asian, and European vehicles, 1996+
  - Performs 11 Common Service Tasks
  - Direct-to-system access for popular service functions
  - Bluetooth VCI with CanFD and DoLP support
  - Read and Erase codes, view freeze frame & live data
  - Quick Browser-Based Code Lookup



AutoLINK® AL329  
SKU #103946 | Part #AL329  
• Read/Erase Engine DTCs  
• One-Touch I/M Readiness /LED Indicator  
• Display Live & Freeze Frame Data



MaxiSYS® MS909CV  
SKU #1174556 | Part #MS909CV  
• For Class 1-8 Commercial Vehicles  
• Topology Mapping on Select Models  
• Engine Coverage for Construction & Agricultural Vehicles



MaxiSYS® MS906 MAX  
SKU #1661671 | Part #MS906MAX5YR  
• 10.1" professional diagnostics and service tablet  
• Perform all-systems diagnostics  
• Bi-directional Active Tests & Special Functions



MaxiCheck® MX900  
SKU #1661670  
Part #MX9005YR  
• Read & Erase Codes  
• Bidirectional Active Tests and Special Functions  
• 40+ Function Service Menu



MaxiIM® IM608PROIIPKA  
SKU #1336440  
Part #IM608PROIIPKA  
• IMMO and Key Programming Bundle  
• Program IMMO & Keys for U.S., Asian, and European Vehicles  
• IM608PROIIPKA Tablet, XP400Pro, Wireless JVCI, IMKPA Key Programming Adapter Kit



MaxiIM® IM508S  
SKU #1442228  
Part #IM508S  
• Fast and Portable IMMO & Key Programming Tablet  
• Includes the XP200 Key Programmer

MaxiIM® KM100  
SKU #1242003  
Part #KM100

- Advanced key and IMMO 5.5-in. touchscreen tablet with 2 IKEYS
- Program Autel's IKEY universal keys as smart key replacement for 3,000+ vehicles
- One-minute Key generation, Easy key button customization



CALL FOR PRICE

AUTEL®

## LANG

### TU-113PB Fuel Injection Pressure Tester

SKU 1330689 **94<sup>99</sup>**  
LNGTU-113PB

- Works on Most Domestic and Import Vehicles

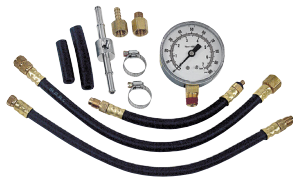

### Cylinder Leakage Tester with 2 Gauges - 100 psi

SKU 1580933 **149<sup>99</sup>**  
LNGCLT-2

- 2 Gauges: 1 for Compression Reading and 1 for Shop Air
- Easy Adjustable Regulator
- Protective Boots for Gauges
- Additional Adapters Available
- Includes: Storage Case



### TU-550 Master Fuel Injection Pressure Tester



SKU 1330693 **674<sup>99</sup>**  
LNGTU-550

- Covers All Domestic and Foreign Platforms 1988 to Present



Does Not Include CIS and TBI Adapters

## Fuel System Cleaners



### Carbon Clean 1000

SKU OSB MVC500-0220 **2,149<sup>99</sup>**

- Complete, Through the Rail, Fuel System Decarbonizing Service
- Fuel Rail Hookup Provides the Most Effective Results
- Online Application Guide
- Unique Time Saving Adapter System
- Cleans Fuel Injectors, Combustion Chamber and Intake Valves
- Works with MV5 (400-0050) Fuel System Cleaner



### MV5 Press Gas/Petrol Fuel System Cleaner 17 Oz. (6 Pk.)

SKU OSB MVC400-0050 **129<sup>99</sup>**

For OSB, Call 901-300-4878

## SUR&R®

### S-Hook Sprayer

SKU 1149152 **74<sup>99</sup>**  
SURS-TOOL

- Nozzle End Produces Fine Mist Spraying Action for Thorough Cleaning of the Air Intake
- Helps Improve Fuel Performance
- Removes Carbon Build-Up
- For Use with SURFIC203

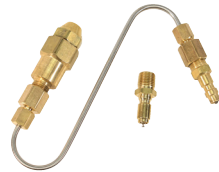

### Fuel Injection Cleaner Kit

SKU 1137808 **439<sup>99</sup>**  
SURFIC203

- Makes Connections Quickly and Easily Using S.U.R.&R.'s Exclusive Quick Connects
- Holds Up to 18 Oz. of Canister Cleaning Solution
- Cleans More Thoroughly Than Aerosol Methods
- Easy to Connect and Use with Shop Air
- For Top Engine and Throttle Body Cleaning

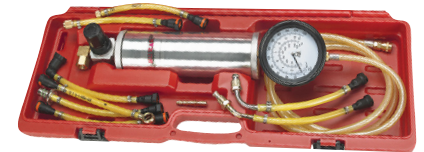

# AUTEL MAXISYS SOLUTIONS FOR EVERY SHOP



## IA700 MODULAR WHEEL ALIGNMENT PRE-CHECK

ADVANCED DIAGNOSTICS + WHEEL ALIGNMENT PRE-CHECK

The ultimate diagnostic and alignment pre-check system with ADAS-capability to future-proof your shop. SKU 1484478 | Part #IA700T



## IA900 COMPLETE WHEEL ALIGNMENT & VEHICLE DIAGNOSTICS

ADVANCED DIAGNOSTICS + WHEEL ALIGNMENT

An industry-first, camera-based, complete diagnostics and wheel alignment system. Add ADAS Calibration with additional purchase to future-proof your shop.

SKU #1281937 | Part #IA900WAT

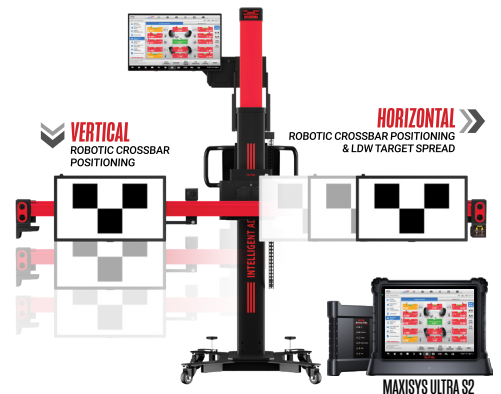

## IA1000 AUTOMATED ADAS CALIBRATION & WHEEL ALIGNMENT SYSTEM

FULLY ROBOTIC FORWARD-FACING CALIBRATIONS

The ultimate robotic digital target ADAS calibration system with Ultra S2 diagnostics and wheel alignment all in one convenient system. SKU #1573142 | Part #IA1000ASTDT

CALL FOR PRICE

AUTEL®

# DIAGNOSTICS

## Power Probe

### Power Probe III with Case and Accessories

SKU 262523  
PWPPP319FTC **229<sup>99</sup>**

Other Colors Available on [AZTOOL1.com](http://AZTOOL1.com)

- Relay and Component Tester
- Voltmeter and Continuity Tester
- Audio Tone
- 20' Jumper Lead
- Works on 12V to 24V Sources



### Power Probe III with Lead Set

SKU 1330690  
PWPPP3LS01 **319<sup>99</sup>**

- Supplies Power and Ground
- Digital Voltmeter with Min./Max. Voltage Capturing
- 4 mm Banana Jack
- 20 Ft. Power Lead



POWER PROBE

### Power Probe III Master Combo Kit

SKU 1105994  
PWPPPKIT03S **489<sup>99</sup>**

- Power-Up Components
- Audible Monitoring of Electrical Signals Voltmeter
- 12V to 24V Range
- Bad Ground Indicator
- Continuity Tester
- Relay and Component Tester
- Trace Short and Open Circuits



### Power Probe IV Master Kit

SKU 1330692  
PWPPPKIT04 **609<sup>99</sup>**

- Supply Power or Ground for Functional Component Testing
- Self-Resetting Thermal 8 Amp Circuit Breaker
- Multiple DC Volt Readings on the Same Display
- Quickly Determine if the Circuit is Open or is Shorted



### Power Probe III Circuit Tester

SKU 1580942  
PWPPP3CSRED **174<sup>99</sup>**

- Digital Voltmeter
- Continuity Tester
- 20' Jumper Lead Set
- Relay and Component Tester
- Removable Probe Tip Adapts to Any 4 mm Lead
- 2 Bright LED Lamps
- Quickly Supply Power and Ground to the Tip



### Power Probe III Professional Electrical Test Kit

SKU 1330691  
PWPPPPOKIT01 **389<sup>99</sup>**

- Supplies Power and Ground for Functional Component Testing
- CAT-IV 600V Hybrid Safe AC/DC Voltmeter
- Measures Resistance to 60M Ohms
- Measures Current from .001 Amps to 10 Amps



### Power Probe IV with Case and Accessories

SKU 802331  
PWPPP401AS **359<sup>99</sup>**

- Supplies Power and Ground for Functional Component Testing
- Digital Volt and Ohmmeter for Circuit Testing
- Large Color LCD Screen with Easy to Navigate User Menu
- AC-RMS, AC Peak-to-Peak, Frequency and Pulse Width for Signal Testing
- Fuel Injector Tester for Easy Circuit Diagnosis
- PCM/ECM Driver Supplies Safe Voltage for Testing Circuits



## TEXA

### Axone Light Car Diagnostic Kit (NANO)

SKU OSB  
TEXAXLTAKN **3,699<sup>99</sup>**

The Navigator NANO S can perform diagnostic operations on all major brands of cars and light commercial vehicles. It is the perfect entry level scan tool for automotive repair shops.

- Axone Nemo Light Rugged Tablet
- Navigator NANO S VCI
- IDC5m Car Software License
- Rugged Carrying Case with Custom Foam
- Motor TruSpeed Repair Included



For OSB, Call 901-300-4878

### Axone Light Car Diagnostic Kit (Multihub)

SKU OSB  
TEXAXLTAKMH **4,999<sup>99</sup>**

The TXT MULTIHUB is TEXA'S flagship scan tool. It is IP53 Certified, can handle Doip, Can-FD, J2534/RP1210 protocols and more. Perfect for advanced diagnostics and shops that want the capability to work in more than one environment from the same device.

- Axone Nemo Light Rugged Tablet
- Navigator TXT Multihub
- IDC5m Car Software License
- Rugged Carrying Case with Custom Foam
- Motor TruSpeed Repair Included



For OSB, Call 901-300-4878

TEXA

## Mityvac®

### Professional Compression Test Kit

SKU 972276 **119<sup>99</sup>**  
MITMV5530

Everything You Need to Perform Cylinder Compression Tests on Motorcycles, Marine and Small Engines and an Air-Hold Adapter for Performing Valve Seal Repairs

- Adapters Include: 10 mm, 12 mm, 14 mm and 18 mm
- Extended Hoses for Hard-to-Reach Cylinders
- Large 2-3/4" Easy-to-Read Gauge
- Quick Disconnect Fittings



### Silverline Elite Test Kit

SKU 988888 **144<sup>99</sup>**  
MITMV8500

- Provides Either Vacuum or Pressure with Equal Precision and Convenience
- Performs Engine Performance Diagnostics, Brake Bleeding, Fluid Transfer, Evacuation, Sampling and More
- Includes Components Needed to Perform Hundreds of Diagnostic and Mechanical Tests



### Power Steering Adapter Kit

SKU 752069 **89<sup>99</sup>**  
MITMVA670

- Works with a Hand Vacuum Pump
- Helps Remove Trapped Air in the Power Steering System
- Includes: Universal Power Steering Adapter (MVA660), GM Power Steering Adapter (MVA661), Ford Power Steering Adapter (MVA662)



### Digital Gas Engine Compression Test Kit

SKU 383182 **224<sup>99</sup>**  
MITMV5532

- Stores Maximum Compression Value for Up to 12 Cylinders
- 3 Minute Auto Shut-Off
- Sealed, Grease and Oil-Resistant Gauge Face Prevents Contamination of Electronics
- Displays Values in psi, Bar and kPa



### Diesel Digital Compression Test Kit

SKU OSB **399<sup>99</sup>**  
MITMV5535

- Features an Electronic Tester that Memorizes Peak Values for Each Cylinder Injector Adapter
- Includes: (2) Injector Adapters and (4) Glow Plug Adapters for Testing Most Modern Diesel Cars and Light Trucks Sold in the U.S.



### Ford 6 Liter Adapter

SKU 972279 **54<sup>99</sup>**  
MITMVA5610

- Glow Plug Adapter - M14 x 1.25
- International VT365
- Ford Power Stroke, 6.0 Liter Engine



For OSB, Call 901-300-4878

## INNOVA®

## OE-LEVEL DIAGNOSTIC TOOLS US-BASED SUPPORT

### SDS-Pro

Contact commercial sales manager for pricing.

INNOVA® 7111  
SKU#1062521

- Secure Gateway (SGW) access on 2018 & newer FCA vehicles
- Active Tests and Special Functions

- OEM Diagnostics
- Removeable VCI - Wireless Diagnostics
- FREE access to RepairSolutions PRO built-in



POWERED BY REPAIR SOLUTIONS PRO

### SDS-Tech

Contact commercial sales manager for pricing.

INNOVA® SDS50  
SKU#1269649

- OEM Diagnostics
- Active Tests and Special Functions for ECM/PCM, TCM

- Reads TPMS/Tire Pressure
- Service Check and Warning Light
- FREE access to RepairSolutions PRO



POWERED BY REPAIR SOLUTIONS PRO

### SDS-Inspector

Contact commercial sales manager for pricing.

INNOVA® SDS43  
SKU#1269650

- OEM Diagnostics
- Active Tests and Special Functions for ECM/PCM, TCM

- Reads Tire Pressure, Service Check and Warning Light
- Multiple Report Types
- FREE access to RepairSolutions PRO



POWERED BY REPAIR SOLUTIONS PRO

### INNOVA® AUTOMOTIVE DIGITAL MULTIMETER

3340  
SKU#94874

- Tests alternators, diodes, solenoids, breaker points, wiring, switches and more
- 10 MegOhm impedance prevents damage to ECU
- Measure RPM, Dwell, Frequency, Temperature, Pulse Width, Duty Cycle
- Accessories included



POWERED BY REPAIR SOLUTIONS PRO

Download on the App Store  
GET IT ON Google Play

Trusted data, powerful reporting, and pro-grade insights built to give technicians the edge in every job.

- Verified Fixes
- Technical Services Bulletins (TSBs)
- Scheduled Maintenance
- Repair Tips
- Parts/Tools for Repair
- Predicted Repairs



SCAN TO LEARN MORE

FREE ACCESS. NO SUBSCRIPTION REQUIRED.

### INNOVA® AUDIO ENHANCED INSPECTION CAMERA

3381  
SKU#1392578

- Record video and audio
- 8 Bright Illumination LEDs fully light up the inspection area
- IP67 Rated Submersible Lens allows safe inspection of areas contaminated by oil or water

Accessories Included: Magnet, Hook and Mirror



## HIGH-POWERED, RECHARGEABLE WORK LIGHTS



### Portable Dual Mode LED Work Lights with Multi-Position Mounting

- Dual Mode Features a Flood LED Work Light and a Directional Flashlight
- 180° Magnetic Adjustable Base
- USB-C Rechargeable



WATER RESISTANT IPX-6



180° Multiple Positions for Angling Light

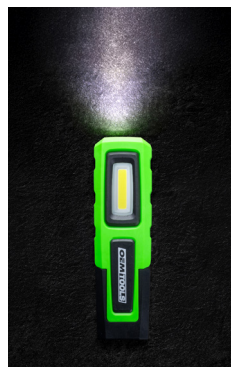

#### 200 Max. Lumens

SKU 1525563 32132 **45<sup>99</sup>**

- Heavy-Duty Belt Clip
- Charging Time: 2.5 Hours

#### LUMENS



#### RUNTIMES



Magnetic Base

#### 400 Max. Lumens

SKU 1525555 32124 **49<sup>99</sup>**

- 360° Rotating Hanging Hook
- Charging Time: 2.5 Hours

#### LUMENS



#### RUNTIMES



Magnetic Base

#### 600 Max. Lumens

SKU 1525559 32126 **54<sup>99</sup>**

- 360° Rotating Hanging Hook
- Charging Time: 3.5 Hours

#### LUMENS



#### RUNTIMES



Magnetic Base

### Flashlights

#### 2 Pack Button LED Lights

SKU 1525557 32129 **39<sup>99</sup>**

- Magnetic Base for Hands-Free Use
- Charging Time: 0.5 Hours
- Includes: Two LED Lights with Two Charging Ports, USB-C and Micro USB, and 1 Charging Cable



Magnetic Base

#### LUMENS



#### RUNTIMES

#### Mini Rechargeable LED Light

SKU 1525564 32137 **22<sup>99</sup>**

- Dual Mounting Options; Heavy-Duty Clip and Dual Magnets
- Charging Time: 2.5 Hours



Heavy-Duty Clip

Magnetic Base

#### LUMENS



#### RUNTIMES

#### LED Light with Auto Sensor

SKU 1525569 32122 **47<sup>99</sup>**



- Auto Sensor Automatically Turns Light Off When Sensor is Covered
- Dual Mounting Options; Heavy-Duty Clip and Dual Magnets
- Charging Time: 3.5 Hours

#### LUMENS

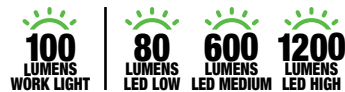

#### RUNTIMES



Heavy-Duty Clip

Magnetic Base



LIGHTWEIGHT 5.2 oz.



## Work Lights



### 3-in-1 Multi-Use Rechargeable Diagnostic Under-the-Hood Work Light

SKU 591153 **129<sup>99</sup>**  
24609

- 3 Different Light Modes - White, Yellow (Smoke Detection), UV/Black (Leak Dye Detection)
- 400 Lumens of Super Bright Light Lasts More Than 5 Hours (White Light)
- Holds Charge for a Longer Run Time with 4400 mAh Li-ion Battery
- Built-In Power Bank/Source Charges Cell Phones, Tablets and Handheld Devices
- Includes Universal Micro USB Charger
- LCD Battery Indicator Screen Displays Charge Level
- Strong Magnets on Each End
- Run Time: White (5.5 Hrs.), Yellow (5.5 Hrs.), UV/Black (12.5 Hrs.)
- Accessory Kits Available

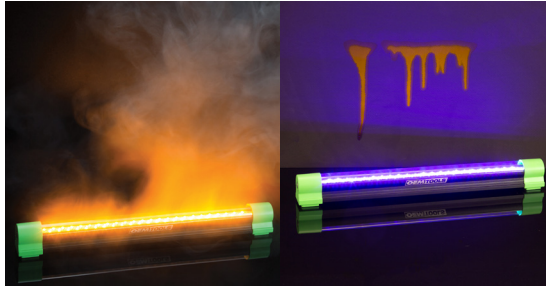

UV Leak Dye Detection Light

400 Lumens Super Bright Work Light

Yellow Smoke Detection Light



MAX OUTPUT  
**400**  
LUMENS

MAX RUNTIME  
**5.5 hrs**

### Multi-Application Work Lights Deliver the Versatility of Several Lights in a Single Unit

#### 600 Max. Lumens

SKU 822266 **69<sup>99</sup>**  
25997

- 6 Hr. Runtime on High

13.4"



5 Light Modes: High, Medium, Low, Strobe, SOS

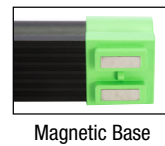

#### 360 Max. Lumens

SKU 603726 **45<sup>99</sup>**  
24695

- 3.5 Hr. Runtime on High
- 4000 mAh Li-ion Battery

8.5"



4 Light Modes:  
High, Medium,  
Low, SOS

**STORE STOCKED**

### Mechanics 500 Max. Lumen Rechargeable Flashlight and 450 Lumen Ultra Slim Wand with UV Inspection

SKU 344835 **99<sup>99</sup>**  
24607

- 5 Light Modes: 100%, 50%, 25%, Strobe and SOS
- Flashlight Head Can Be Removed and Replaced with the Slim Inspection Light (as Shown)
- 3 Powerful, UV LED Lights on Inspection Light Detect Leaks Quickly and Easily



### Magnetic Rechargeable LED Work Light

SKU 819644 **77<sup>99</sup>**  
25982

- 3W COB LED, Super Bright White Lights: 400 Lumens
- 3.7V 2200 mAh Li-ion Battery
- Runtime: 3 Hrs. (Work Light), 9 Hrs. (Torch Light)
- Powerful Magnets on the Back and Swivel Base
- Includes: USB Cable for Recharging

Swivels, Hangs or Sticks



MAX OUTPUT  
**400**  
LUMENS

MAX RUNTIME  
**9.0 hrs**

### Pivoting Ultra-Slim 300 Max. Lumen Work Light

SKU 603727 **41<sup>99</sup>**  
24696

- Ultra-Slim Body Design Pivots 180° Providing More Light to Any Work Area
- Magnetic Base Attaches to Any Ferrous Surface
- 4 Light Modes: High, Low, Top Light and Handle Spotlight
- Top Light Illuminates the Tightest Work Areas

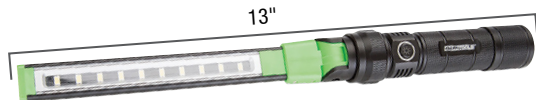
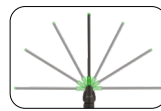

MAX OUTPUT  
**300**  
LUMENS

MAX RUNTIME  
**15 hrs**

### Rechargeable Multi-Head All-in-One Work Light Kit

SKU 765525 **119<sup>99</sup>**  
24648

- Quick-Attachment Coupler Allows for Easy Change Between 3 Interchangeable Heads

Comes with USB Charging Cord, AC Adapter, 180° Swivel Hook and (1) 18650 Rechargeable Battery

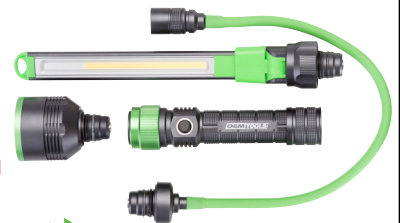

MAX OUTPUT  
**350**  
LUMENS

MAX RUNTIME  
**2.5 hrs**



### Work Lamp Attachment for 24648 Work Light Set

SKU 884377 **22<sup>99</sup>**  
24648E



**STORE STOCKED**

# LIGHTING

## Flashlights

### Periscope LED Flashlight

SKU **OSB 25458** **14<sup>99</sup>**

- Chip On-Board LED
- Beam Distance: 2 Meters
- Includes: Magnetic Base to Stand Upright and 2 AA Batteries

For OSB, Call 901-300-4878



**OEM TOOLS**



60 LUMENS



6.0 hrs MAX RUNTIME

### E54 Cree 700 Lumens Tactical Flashlight

SKU **347200** **59<sup>99</sup>**  
EXPE54

- Water and Shock Resistant Aluminum Body
- No-Slip Grip Surface
- Beam Distance: 300 Meters

Requires 2 or 4 CR133A Batteries (Not Included)



700 LUMENS

3.0 hrs RUN TIME

## Headlamp



### Ultra-Bright Double Strip Headlamp

SKU **OSB** **44<sup>99</sup>**  
SLPSP81463

- Fast Charging USB Type C System
- Ultra Bright 3W COB LED Floodlight with 4 Brightness Settings
- High Power COB LED Beam Spot Light with 2 Brightness Settings
- Smart On/Off Motion Sensor
- Ultra Lightweight, Sleek, Slim, Low Profile Design
- Adjustable Headband with Non-Slip Grip
- IP44 Water Resistant Rating
- SOS Emergency Flash Mode



For OSB, Call 901-300-4878

### E36 Cree Rechargeable Flashlight Kit

SKU **568461** **84<sup>99</sup>**  
EXPE36-E02

- Beam Distance: 300 Meters
- Impact Resistant Up to 1.5 Meters
- IPX-6 Water Resistant
- Includes: (1) 18650 Battery and Charger



**GreatLite**



1000 LUMENS  
2.0 hrs RUN TIME

### Stinger LED with AC/DC

SKU **291368** **260<sup>99</sup>**  
STL75732

- 425 Lumens
- Runtime: 10 Hours
- Beam Distance: 322 Meters
- Four Lighting Modes: High, Medium, Low and Strobe



**STREAMLIGHT**

## Pocket Lights



### Stylus Pro with White LED

- 48 Lumens
- Runtime: 7.5 Hours
- Waterproof Construction with an Unbreakable Polycarbonate Lens Pocket Clip

**Blue** SKU **291362**  
STL66122

**Red** SKU **291358**  
STL66120

**Black** SKU **291408**  
STL66118

**39<sup>99</sup> each**

**Silver** SKU **291359**  
STL66121



### Cree LED Pen Light

- 3 Modes: Low (50 Lumens), High (150 Lumens) and Strobe
- 80 Meter Beam Distance
- Anodized Aluminum Body is Impact and Water Resistant
- Battery Runtime: 6 Hours (Low), 3 Hours (High)
- Comes with 2 AAA Batteries and Tactical Clip

**Red** SKU **592188** **29<sup>99</sup> each**  
32838

**Silver** SKU **592183**  
32839

**Black** SKU **592184**  
32835

**Green** SKU **592186**  
32837

**Blue** SKU **592185**  
32836



150 LUMENS

6.0 hrs MAX RUNTIME



### 2-in-1 Rechargeable Pocket Light

SKU **081751** **24<sup>99</sup>**  
26029

- Super Bright COB LED Work Light with Integrated LED Flashlight
- Easy Hands-Free Operation with Magnetic Base and Magnetic Pocket Clip
- Max. Output (Work Light): 200 Lumens
- Max. Output (Flashlight): 140 Lumens
- Includes: (1) 18650 Li-ion Rechargeable Battery and (1) USB Charging Cord



MAX OUTPUT  
200 LUMENS

3.0 hrs MAX RUNTIME



## Underhood Light



### Cordless Underhood LED Work Light

SKU **OSB** **199<sup>99</sup>**  
SPLSP81466

- High-Power SMD LEDs with Diffused Lens
- Brightness Control - 2 Settings
- Extends from 1150 mm to 1800 mm
- Soft Padded Hooks
- 360° Swivel and Wide 120° Light Spread



**NEW**

For OSB, Call 901-300-4878

## Inspection Light



### 700 Max. Lumen Rechargeable COB LED Slim Inspection Light

SKU **418752** **23<sup>99</sup>**  
24646

- Unique Variable Dial Lets You Control Output (0 to 700 Lumens)
- Runtime: 10 Hours (at 50% Power), 2.5 Hours (at 100% Power)
- Removable Magnetic Base with 360° Swivel and Lock Feature Lets You Adjust Angle to Point Light Where it's Needed



MAX OUTPUT  
700 LUMENS

10 hrs MAX RUNTIME

## Extension Cord Reel



### Flexzilla Pro Extension Cord Reel

SKU **OSB** **189<sup>99</sup>**  
LEGFZ8120603

- Self-Leveling System Winds the Cord Evenly
- Lighted Triple Tap Outlet for Plenty of Capacity
- Circuit Breaker Reset Button Prevents Breaker Tripping and Blown Fuses
- Oil-Resistant 12/3 AWG SJTOW Cord Flexible in Low Temperatures and Resists the Effects of Oil, Water and Sunlight
- Impact-Resistant Housing; Cord Locks Out in 2 Ft. Increments



For OSB, Call 901-300-4878

# BATTERY SERVICE

TO ORDER, contact your Commercial Sales Manager or go to [AutoZonePro.com](http://AutoZonePro.com)

BATTERY SERVICE

## Battery Testers

### Battery Conductance Tester

**MIDTRONICS** Advancing Battery Management

SKU 291330 **249<sup>99</sup>**  
MIDPBT100

- Tests Both the Starter and the Charging System
- Tests 12V Automotive Batteries from 200 to 850 CCA's
- Durable Design for the Workshop or in the Field



### BT MobilePro S Jump Start/Power Bank/BSC System Analyzer

SKU 1485041 **155<sup>99</sup>**  
TPDBTMPROS

- Turns Your Diagnostic Scan Tool into a Battery Tester
- Compatible to Phoenix Line of Diagnostic Scanners
- Battery, Cranking and Charging Tests
- Tablet Compatibility
- Test Voltage: 12V
- Test Range: 100~2000CCA
- Battery Type: Regular Flooded, AGM, EFB and GEL
- Test Standards: CCA, BCI, CA, MCA, JIS, DIN and More



### 100 Amp Battery Load Tester

SKU 203583 **48<sup>99</sup>**  
24338

- Conveniently Tests Batteries in Just 10 Seconds
- Battery Load Test: 100A (12V), 50A (6V)
- Designed to Work on Both 6V and 12V Batteries Up to 1,000 CCA
- Determines State of Charge, Cranking and Charging Volts
- Convenient Handle for Transport



### 500 Amp Carbon Pile Load Tester

SKU 1168827 **149<sup>99</sup>**  
24336

- Variable Load Capability to 500 Amps
- Tests Batteries to 1,000 CCA
- Test Alternators, Regulators and Starters
- Large, Easy-to-Read Gauges
- Heavy Duty Clamps



### Battery Tester with Printer

SKU OSB **299<sup>99</sup>**  
TPDBT600P

**TOPDON**

- 6V/12V/24V Battery, Cranking and Charging Tests
- Onboard Power Tests Low Batteries Down to 2 Volts
- Built-In Thermal Printer for Instant Reports
- 100-2000 CCA Range with 3.5" Color Display
- Supports Multiple Battery Types: Flooded, AGM, GEL, EFB and VRLA
- Stores Up to 10 Previous Test Results
- Resistance, Sequence and Low Voltage Testing
- Measures Resistance for Lead-Acid, Lithium, Alkaline and Carbon-Zinc Batteries

**NEW**



For OSB, Call 901-300-4878

### BT600 Battery Tester with Printer

SKU 1339732 **139<sup>99</sup>**  
TPDBT600

**TOPDON**

- 3.5" Color Screen
- Built-In Thermal Printer for Instant Reports
- 100-2000 CCA Range with 3.5" Color Display
- Supports Multiple Battery Types: Flooded, AGM, GEL, EFB and VRLA
- Performs Complete Battery, Cranking and Charging Tests
- Large, Reinforced, Smoke-Free and Spark-Free Copper Clamps
- Quick and Accurate Test Results



### Replacement Clamps

SKU 1544657 **29<sup>99</sup>**  
TPDBT600RC

### Thermal Printer Paper for BT600, BT300P

SKU 1442591 **19<sup>99</sup>**  
TPDBTPAPER

### 12V Digital Battery Electrical System Tester with Printer

**ASSOCIATED**

SKU 343373 **479<sup>99</sup>**  
ASC12-1015

- Tests Both Batteries Up to 1,700 CCA and Alternators
- Tests Starters and Charging Systems
- Backlit Digital Display
- 9 Languages
- Includes: Deluxe Case and Extra Print Paper



### 12/24V Digital Battery Electrical System Tester with Printer

SKU 1491305 **549<sup>99</sup>**  
ASC12-2415

- Tests Both Batteries Up to 2,000 CCA and Alternators

## Battery Service Tools

### Side Terminal Battery Wrench

- For Use with Side Terminal Batteries Found on Many GM and Other Domestic Vehicles



25282

**5/16"**  
SKU 466513 **9<sup>99</sup>**  
25287

- Length: 5-1/2"

**10 mm and 5/16"**  
SKU 965838 **18<sup>99</sup>**  
25282

- Length: 12"
- Double Sided



For Use on 5/16" and 10 mm Battery Terminals

### 2 Liter Battery Filler

SKU 972771 **12<sup>99</sup>**  
87010

- Automatic Shut-Off to Prevent Overfilling
- Fills Battery to Proper Level without Spilling



### Battery Terminal Puller

SKU 466489 **14<sup>99</sup>**  
25121

- Use to Remove Battery Terminal Clamp without Damaging the Battery Post
- Puller Will Also Work on Corroded Spring-Type Clamps

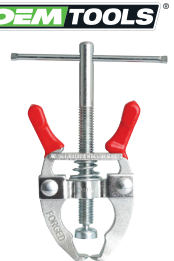

### Battery Nut Pliers

SKU 943134 **15<sup>99</sup>**  
25123

- Easily Tighten and Loosen Nuts
- Offset Handles
- Serrated Jaws for a Firm Grip



### Battery Carrier

SKU 094644 **19<sup>99</sup>**  
25283

- Designed to Grab, Lift and Carry Top Post and Side Terminal Batteries
- Grips Battery Widths from 5" to 7" with Rubber Pads
- Plastic Hand Grip Provides a Firm Hold



### 6 Piece Battery Service Kit

SKU 1168822 **79<sup>99</sup>**  
25110

- Includes: Battery Terminal Puller, 4-Way Post Cleaner, Battery Nut Pliers, Extended 5/16" and 10 mm Battery Terminal Wrench, 5/16" Side Terminal Battery Wrench and a Side Terminal Brush Organized in a Heavy Duty, Roll-Up Storage Sleeve



Prices subject to change without notice. Prices do not include applicable taxes, vehicles, tires, rims, installation or optional equipment as shown. Please do not return purchases to the store. For information regarding warranty, repair, or any questions or concerns, call 901-300-4878.

AZG0226

35

# BATTERY SERVICE

## Jump Starters

### Battery Tester and Jump Start

SKU 1368635 **124<sup>99</sup>**  
TPDV2200PLUS

- Jump Start Capacity: 8L Gas, 6L Diesel
- 2200A Peak Current for Jumps
- Use the App to Perform Detailed Battery Tests
- 300 Lumen LED Light with Solid, SOS and Strobe Functions
- Output Ports: Type-C: USB1, USB2, DC



TOPDON®

### 2-in-1 2200 Peak Amp Jump Starter and Tire Inflator

SKU 1485043 **159<sup>99</sup>**  
TPDV2200AIR

- Battery Capacity: 12,000mah
- Delivers a Powerful 2200A Peak Current with Up to 25 Starts Per Charge
- Capable of Jump-Starting Vehicles with Engines Up to 8.0 Liters for Gasoline or 6.0 Liters for Diesel
- Functions as a PD45W Fast-Charging Power Bank
- 400-Lumen LED Flashlight
- Tire Inflator Fills in Under 3 Minutes



TOPDON®

### Battery Jump Starter, Power Bank and Flashlight

SKU OSB **199<sup>99</sup>**  
TPDV3000

- 3000 Peak Amps and 750A Sustained Current Allow Instant Jump-Starting for Large Engines
- Multi-Function Power Bank with Fast Charging and 12V/10A DC Output
- Advanced Safety with 10 Protection Features Including Stop Spark™ Technology
- Built for Extreme Weather and Rugged Conditions



TOPDON®

### 2-in-1 4500 Peak Amp Jump Starter and Battery/System Tester

SKU 1485040 **279<sup>99</sup>**  
TPDV4500PLUS

- Up to 45 Jump Starts on a Single Charge
- Test and Monitor Battery with App
- Peak Amps: 4500
- 500 Lumen Flashlight
- Outputs: Bidirectional TYPE-C, USB1, USB2
- IP65-Rated Casing
- Includes: D45W Charger Adapter, DC Adapter, DC Adapter and PD100W Cable



TOPDON®

### 1700 Peak Amp 12 Volt Jump Starter

SKU OSB **299<sup>99</sup>**  
SOLJNC660

- Heavy Duty Clamps with 46" #2 AWG Welding Cables
- 1700 Peak Amps; 425 Cranking Amps
- Heavy Duty Clamps with 46" Cables



SOLAR®

### Premium 1700 Peak Amp 12 Volt Jump Starter

SKU OSB **324<sup>99</sup>**  
SOLJNC770R

- Heavy Duty Clamps with 68" Cables
- 1700 Peak Amps; 425 Cranking Amps
- Dual USB Outlets to Charge Mobile Devices
- Master ON/OFF Switch



SOLAR®

### 3400 Amp 12/24 Volt Jump Starter

SKU OSB **649<sup>99</sup>**  
SOLJNC1224

- Voltmeter Provides Charge Status of Onboard Battery
- Clore PROFORMER Battery Technology
- 3400 Peak Amps and 850 Cranking Amps - 12V
- 1700 Peak Amps and 425 Cranking Amps - 24V



SOLAR®

### Kwikstart® 12 Volt Portable Power and Jump Start

SKU 850637 **264<sup>99</sup>**  
ASC6256

- Peak Amp Output: 1700 Amps
- 360 CCA of Boost Assist
- (2) 12V DC Accessory Outlets to Power and/or Recharge DC Electronics
- 32" Heavy Duty Cables and USB Port



ASSOCIATED

To Confirm Price, Availability and Ordering Instructions on OSB, Call 901-300-4878

## Booster Cables

### 20 Ft. 4 Gauge Booster Cables with Storage Bag

SKU 1168815 **44<sup>99</sup>**  
24335

- Extra Long 20 Foot Flexible Cables Expands Your Reach
- Tangle-Free Design Ensures Quick and Easy Connections
- Insulated Clamps Fit Top and Side Post Batteries
- Oil, Gas and Acid-Resistant All Copper Wire
- Includes Storage Bag

20 Ft. Extra Flexible Cables



OEM TOOLS®

## Remote Starter

### Remote Starter Switch

SKU 265124 **20<sup>99</sup>**  
25330

- Heavy Clips with Insulated Sleeves Attach to Ground and Starter Solenoid Switch
- Thumb Activated Switch
- 83" Heavy Insulated Wire for Long Tool Life



OEM TOOLS®

# BATTERY SERVICE

TO ORDER, contact your Commercial Sales Manager or go to [AutoZonePro.com](http://AutoZonePro.com)

BATTERY SERVICE

## Associated Battery Chargers

**ASSOCIATED**



Safe In Any Weather



Made in USA



ASC6002B

ASC6021AGM

ASC6012AGM

ASC6008MSK

ASC6007B

ASCIBC6008MSK

	Commercial Duty Charger	Heavy Duty Fleet Charger/Analyzer	Heavy Duty Charger	Intellamatic® Charger and Reflash Power Supply			
	SKU 221248 ASC6002B	SKU 1414394 ASC6021AGM	SKU 662763 ASC6012AGM	SKU 344790 ASC6008MSK (Not Pictured)	SKU 343379 ASC6008MSK	SKU 343370 ASC6007B	SKU 662745 ASCIBC6008MSK
Charger Type	Wheel	Wheel	Wheel	Wheel	Wheel	Wheel	Wheel
UL of CSA Continuous Amperage Charging Rate	100/80A	70/65/30A	70/60A	60A	60A	40A	60A
Re-Flash Power Supply Output Amperage	N/A	N/A	N/A	70A @ 13.9V	70A @ 13.9V	45A @ 13.9V	70A @ 13.9V
Crank Assist Amperage	400	205A	250	270	270	130	270
Operating Charging Voltage	6/12/18/24V	6/12/24V	6/12V	12V	12V	12V	12V
Battery Types	SLA	SLA, AGM, EFB	SLA, AGM, EFB	SLA, AGM, Gel-Cell, EFB	SLA, AGM, Gel-Cell, EFB	SLA, AGM, Gel-Cell, EFB	SLA, AGM, EFB, Li-ion, Gel-Cell
Smart Charger	N	N	N	Y	Y	Y	Y
Adjustable Charging Voltage	N	N	N	N	N	N	Y
Adjustable Re-Flash Power Supply Voltage	N	N	N	Y	Y	Y	Y
Memory Saver Mode	N	N	N	N	Y	N	Y
DC Cable Length and Gauge	8' 4AWG	6.5' 4AWG	6.5' 6AWG	6.5' 6AWG	6.5' 6AWG	6.5' 6AWG	6.5' 6AWG
Warranty*	2 Year B2B 5 Year Limited	2 Year B2B 5 Year Limited	2 Year B2B 5 Year Limited	2 Year B2B 3 Year Limited	2 Year B2B 3 Year Limited	2 Year B2B 3 Year Limited	2 Year B2B 3 Year Limited
<b>Price</b>	<b>1,259<sup>99</sup></b>	<b>899<sup>99</sup></b>	<b>709<sup>99</sup></b>	<b>1,009<sup>99</sup></b>	<b>1,149<sup>99</sup></b>	<b>809<sup>99</sup></b>	<b>1,419<sup>99</sup></b>

\*Two years bumper to bumper (B2B) manufacturer's warranty with five years transformer/rectifier for heavy duty battery chargers (6001A, 6002B, 6006, 6009 and 6012) and three years transformer/rectifier warranty for INTELLAMATIC wheeled smart chargers.

## Power Supply

**ASSOCIATED**

### 12V - 90A Reflash Power Supply and Charger

SKU OSB  
ASC6006100 **1,669<sup>99</sup>**

- Adjustable Power Supply from 12.6V to 14.9V at Up to 90 Amps
- Safe for All Batteries Including AGM, EFB, Li-ion and Gel
- OEM Vehicle Manufacture Approved
- 8.4 Ft. DC Leads

For OSB, Call 901-300-4878



### 120A Power Supply and Battery Charger

SKU 1485033  
TPDT1200005 **899<sup>99</sup>**

- Intelligent Current (5-120A) and Voltage (11-16.8V) Output Adjustment
- 3 Major Charging Modes and 9-Step Smart Charging
- Compatible with Lead-Acid Batteries and Lithium Batteries
- Clamp Cable Length: 16 Ft.



**TOPDON®**

Prices subject to change without notice. Prices do not include applicable taxes, vehicles, tires, rims, installation or optional equipment as shown. Please do not return purchases to the store. For information regarding warranty, repair, or any questions or concerns, call 901-300-4878.

# BATTERY SERVICE

## Wheeled Chargers



### Battery Charger 12V

SKU **OSB SOL4735** **289<sup>99</sup>**

- EZ View Control Panel
- 200 Amp Engine Starting Assistance
- 40 Amp Fast Charge Rate
- 5 Amp Setting for ATVs, Boats, Lawn and Garden Applications

### Battery Charger with Engine Start 12/24V

SKU **OSB SOL4745** **389<sup>99</sup>**

- 40 Amp 12V, 20 Amp 24V Charge Rate



For OSB, Call 901-300-4878 SOL4735

## 6/12V, 40A Standard **ASSOCIATED** Duty Wheel Charger

SKU 344795 **449<sup>99</sup>** ASCUS20



- 40 Amp Charger with 90 Minute Timer
- 40 Amp Continuous Rating at 6/12 Volts
- 200 Amp Cranking Assist and 330 Amps Boost
- Fan Cooling Prevents Overheating
- UL Listed
- Two Year Manufacturer's Warranty



**BONUS VALUE: \$44.99**



### 20 Ft. 4 Gauge Booster Cables with Storage Bag

24335 With Purchase of: ASCUS20

Offers Good Through June 30, 2026



## Bench Chargers

### 6/12V, 1A Maintainer

SKU 765478 **69<sup>99</sup>** ASC9003A

- LED Lights Indicating Charging Status
- Includes 2 Sets of Charging Leads
- OEM Vehicle Manufacture Approved
- Safe for AGM, Gel Cell, SLA Batteries
- Reverse Polarity Protected
- Overcharge Protection
- 1 Year Warranty



## **ASSOCIATED**

### 6/12V, 15/2A Smart Bench Top Charger

SKU 850634 **199<sup>99</sup>** ASC3100A

- Digital Display Shows Charging Voltage/Amperage or Time Remaining
- Safe for AGM, Gel Cell, SLA Batteries
- 100A Boost
- 1 Year Warranty



## Smart Charger

### 30A Smart Charger and Power Supply

SKU 1442582 **319<sup>99</sup>** TPDT30000

- Suitable for Multiple Battery Types, Including AGM, LI, WET, GEL, MF CAL and EFB
- 9-Step Smart Charging, Checks for Sulphation and Acid Stratification, Repairs Batteries, Prevents Battery Damage
- Works as a Stable Power Supply for 12V and 24V Devices
- Current Range: 12V-30A, 24V-15A, 6V-15A, 12V-10A
- Clamp Cable Length and Gauge: 7.2', AWG10

## TOPDON



One Charger Does It All

# AUTEL MAXIBAS BOOST REVENUE AND CUSTOMER SATISFACTION

UNRIVALED ALL-IN-ONE TOOL FOR TESTING AND ADVANCED BMS FUNCTIONALITIES, INCLUDING BMS RESET AND REGISTRATION.



### ADVANCED BMS FUNCTIONS & ALL-SYSTEM DIAGNOSTICS

- Largest Vehicle Coverage in the Category
- Battery & Electrical System Resets
- One-touch Battery Registration
- Print, Email, or Text Battery and Health Reports to Customer
- 12 and 48 Volt Lithium Ion Capabilities for Mild Hybrid Vehicle Applications
- Read and Clear Codes

### ADVANCED BATTERY DIAGNOSTICS & SERVICE

- Adaptive Conductance Technology Reduces Battery Misdiagnosis
- Eliminate Charge and Retests On Discharged Batteries
- Automatic Vehicle ID with AutoVin, VINscan, and Plate Scan
- Quickly Diagnose Low-capacity Batteries
- Battery Location Diagrams and Guided Replacement Instructions

### MaxiBAS® BT506

SKU #1125835 | Part #BT506

- Use with Smartphone or other Smart Device
- Connects with all Autel Bluetooth capable Professional Tools
- Support In-vehicle and Out-of-Vehicle Testing of Passenger Vehicle Batteries
- Test 6- and 12-volt Batteries: 100 - 2000 CCA
- Test 12- and 24- Cranking/Charging Systems
- Test Flooded, AGM, AGM Spiral, EFB & GEL Batteries



### OBDDII EXTENSION CABLE

SKU #1443473 | Part #VCIEXTCAB

- Compatible with all OBDII-compliant VCIs
- It keeps VCI in sight and is easy to retrieve and not forget after use



### MaxiBAS® BTAK

SKU #1149588 | Part #BTAK

- Battery Tester Accessory Kit
- Digital Multimeter and Current Clamp Kit
- Measures Voltage, Current and Resistance



### MaxiBAS® BT608

The MaxiBAS BT608 is the most versatile standalone handheld battery tester and multi point inspection tool on the market. Capture a complete snapshot of every vehicle's battery and electrical system health, plus gain visibility into all available systems and fault codes.

SKU #1105501 | Part #BT608

- Adaptive Conductance Technology: Detects Battery Capacity Reducing Misdiagnosis
- Auto Battery Reset / Print Test Reports Via Built-in Thermal Printer
- AutoSCAN/VINScan for Quick Vehicle Identification & Battery Specifications



### MaxiBAS® BTMS

SKU #1149587 | Part #BTMS

- Battery Tester Memory Saver
- Preserves Vehicle Codes and Electronic Presets When Replacing Battery
- Enables Vehicle Computer to Be Powered and Maintain Data When Connected to Backup Vehicle Battery



CALL FOR PRICE

**AUTEL**

Prices subject to change without notice. Prices do not include applicable taxes, vehicles, tires, rims, installation or optional equipment as shown. Please do not return purchases to the store. For information regarding warranty, repair, or any questions or concerns, call 901-300-4878.

# GREASE GUNS

TO ORDER, contact your Commercial Sales Manager or go to [AutoZonePro.com](http://AutoZonePro.com)

GREASE GUNS

## Grease Guns

- Cast Iron Pump Head for Added Strength and Durability
- Multiple Filling Options to Support Suction, Filler and Cartridge Loading

- Precision Fit Plunger Prevents Grease Bypass and Resists Scoring
- Heavy Duty Follower Spring Allows Easy Priming and Efficient Pumping

**OEM TOOLS**



87206

**Mini Lever Action**



87204

**Lever Action Clear**

Clear Barrel for Easy Grease Monitoring



87201

**Lever Action**



87203

**Pistol Grip with 18" Extension Hose**



87205

**Pneumatic with 18" Extension Hose**

SKU 1207896   87206	SKU 1207899   87204	SKU 1362012   87201	SKU 1207888   87203	SKU 1207901   87205
• 4,000 Max. psi	• Includes 7" Extension • 10,000 Max. psi	• Includes: 6" Steel Extension • 7,000 Max. psi	• Pistol Grip Handles Supports One Handed Operation • 6,000 Max. psi	• Includes 5.5" Extension • Air Operated for Continuous Lubrication Flow • 6,000 Max. psi
<b>23<sup>99</sup></b>	<b>43<sup>99</sup></b>	<b>32<sup>99</sup></b>	<b>46<sup>99</sup></b>	<b>53<sup>99</sup></b>

## Grease Gun Accessories

### 7 Piece Grease Gun Accessory Kit

SKU 978118 **64<sup>99</sup>**  
25711

- Includes: Press-On 90° Lube Tool, Straight Extension, 300 mm Hose Extension, Slide-On 90° Coupler, Rubber Tip Nozzle, Needle Nozzle and 60° Coupler



### Extension Hoses with Spring Guard

- Premium Grease Hoses for Manual and Air-Operated Grease Guns
- Spring Guard for Added Rigidity to Prevent Kinking
- Max. Working Pressure: 4,500 psi
- Burst Pressure: 12,000 psi
- Accessory Thread: 1/8" NPT



**12"**

SKU 1207902 **11<sup>99</sup>**  
87220

**18"**

SKU 1207887 **11<sup>99</sup>**  
87221

**36"**

SKU 1207893 **18<sup>99</sup>**  
87222

### 70 Piece Grease Fitting Assortment

SKU OSB 25752

**28<sup>99</sup>**

- 70 Assorted Grease Fittings in 6 Popular Sizes



For OSB, Call 901-300-4878

### Bearing Packer

SKU OSB 26540 **25<sup>99</sup>**

- Quickly Flushes Out Old Grease and Repacks Bearings with New Grease
- Transparent, Impact Resistant Cup Allows User to Clearly See Grease Level
- Works on Bearings with Up to 3-1/2" Outside Diameter



For OSB, Call 901-300-4878

### Universal Bearing Packer

SKU 1339731 **9<sup>99</sup>**  
25081

- Connects to Any Grease Gun
- Services Most Roller and Ball Bearings
- Forces Out the Old Grease and Evenly Injects Fresh Grease



## Lincoln

### 20V Li-ion PowerLuber Kit

SKU 751676 **549<sup>99</sup>**  
LIN1884

- Delivers Grease at Up to 10,000 psi
- Built-In LED Illuminates the Work Area
- Includes: Grease Gun, 2 Batteries, Charger and Case
- 36" Flex Hose



### 12V Li-ion PowerLuber Kit

SKU OSB LIN1264 **339<sup>99</sup>**

- Li-ion Battery for Maximum Power and Efficiency
- Delivery at Up to 8,000 psi
- Built-In LED Illuminates Dimly Lit Areas
- 30" Grease Hose



For OSB, Call 901-300-4878

### Fully Automatic Pneumatic Grease Gun

SKU 445386 **174<sup>99</sup>**  
LIN1162

- Fully Automatic, Continuous Operation
- 30" High-Pressure Hose with Coupler and Attachment Clip
- Pump Ratio: 40:1 at 150 psi
- Max. Grease Pressure: 6,000 psi



### Super Pistol Grip

SKU 445385 **89<sup>99</sup>**  
LIN1134

- 18" Whip Hose
- Includes Rigid Pipe
- Variable Stroke Design
- 7,500 psi
- Filler Nipple/ Bleeder Valve



### Professional Lever Grease Gun with 18" Whip Hose and Coupler

SKU OSB LIN1147 **54<sup>99</sup>**

- 3-Way Loading: By Cartridge, Bulk Load and Suction Load



For OSB, Call 901-300-4878

Prices subject to change without notice. Prices do not include applicable taxes, vehicles, tires, rims, installation or optional equipment as shown. Please do not return purchases to the store. For information regarding warranty, repair, or any questions or concerns, call 901-300-4878.

# OIL CHANGE

## Oil Drains

### 18 Gallon Rolling Oil Drain

SKU 988882 **389<sup>99</sup>**  
LIN3601

- All Steel Design Includes Reinforced Caster Supports
- 14" Telescoping Bowl: Range of 45" to 72"
- Preset Air Regulator (Up to 150 psi)
- Pressurized Self-Evacuation Feature Requires Only Shop Air and a Tire Chuck to Discharge Fluids



### 25 Gallon Used Fluid Combo Drain/Evacuator

SKU 543345 **849<sup>99</sup>**  
LIN3639

- Powerful Compressed Air Operated Venturi Vacuum Quickly Draws Fluids from Reservoirs
- Includes: Mercedes-Benz, BMW and VW Dipstick Tube Adapters and 6 Evacuation Wands of Varying Flexibility, Diameter and Length
- Pressurized Self-Evacuation Feature Requires Only Shop Air and a Tire Chuck to Discharge Fluids
- Min. Height: 60"
- Max. Height: 74"



### 25 Gallon Used Fluid Evacuator

SKU 543344 **659<sup>99</sup>**  
LIN3637

### 25 Gallon Used Fluid Gravity Drain

SKU 543350 **779<sup>99</sup>**  
LIN3635

### 18 Gallon Rolling Oil Drain

SKU 667005 **249<sup>99</sup>**  
87042

- Self-Evacuating Design Operates Using Standard Shop Air Connections
- Funnel Capacity: 2.6 Gallons
- Funnel Diameter: 17"
- Min. Height: 44.5"
- Max. Height: 68.5"



### 21 Gallon Oil Drain Vacuum and Extractor

SKU 546658 **699<sup>99</sup>**  
24862

- Designed for the Collection of Used Fluids from Lift Mounted Vehicles or by Evacuation Directly from Fluid Reservoirs or Dipstick Tubes
- Funnel Diameter: 15"
- Funnel Extension Adapter: 22"
- Funnel Height Adjustment: 45" to 62"
- Includes 5 Extraction Tubes: 7 mm x 35"; 6 mm x 29"; 6 mm x 23"; 6 mm x 22" and 3/8" x 15"



### 18 Gallon Rolling Oil Drain

SKU 606546 **329<sup>99</sup>**  
LIN3518

- Durable, High-Density Polyethylene Reservoir with Flat-Top Design to Hold Drain Filters, Tools, Nuts, Bolts, etc.
- Funnel Incorporates Splash Shield to Catch Overspray
- Optional Cam Lock Evacuation Kit



Drain Adjusts from 40" to 77"



Flat-Top Design to Hold Tools, etc.

### Upright Portable Oil Drain

- Features Built-In Drain Valve and Evacuation Spout
- 4 Heavy Duty Casters for Easy Transport
- Includes: Tool Holder



### 9 Gallon

SKU 908386 **169<sup>99</sup>**  
87032

- Adjustable Drain Height: 32" to 62"
- Funnel Diameter: 17"

### 18 Gallon

SKU 908388 **199<sup>99</sup>**  
87031

- Adjustable Drain Height: 54" to 70"
- Funnel Diameter: 18"

### 21 Gallon Waste Oil Drain

SKU 544817 **499<sup>99</sup>**  
24861

- Pressurized Self-Evacuation Feature Requires Only Shop Air
- Large Diameter Funnel Includes a Removable Filter Screen and Wide-Mouth Extension
- Funnel Diameter: 15"
- Funnel Extension Diameter: 22"
- Funnel Height Adjustment: 45" to 62"



Large Funnel



Sight Tube Catches Fluids without Spills

### 21 Gallon Oil Drain Vacuum and Extractor



## Accessories

Prevents Splashing of Hot Oil

### Oil Drain Splash Pads

- Keep Work Areas Clean While Changing Transmission or Other Oils
- Allow Hot Oil to Drain Through Porous Pad

#### 15" Round

SKU 1340218  
SHA73850

**19<sup>99</sup>**



#### 22" Square

SKU 1340219  
SHA73851

**27<sup>99</sup>**



Drains Not Included. Not for Coolants or Fluids That Will Be Recycled in the Vehicle

### Super Transmission Drain Funnel

SKU 291377 **99<sup>99</sup>**  
LIS17902

- Extends the Catch Area of Any Lift Drain
- Fits the Ford E 40D
- Dimensions: 24" x 36"

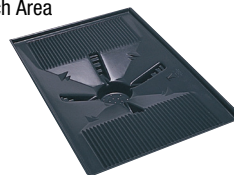

### Transmission Drain Pan

SKU 908383 **39<sup>99</sup>**  
87035

- Flexible Plastic Construction Fits on Top of Funnels for Most Lift Drains
- Built-In Screen to Catch Debris, Parts and Tools
- Dimensions: 22-3/4" (L) x 23-3/4" (W) x 4-3/4" (H)



## Oil Filter Tools

### Filter Removal Cup

- Specifications: 6" x 6" x 6" (34 Oz. or 1 Liter), Volume Sufficient to Hold Typical Size Filters Commonly Used on Cars, SUVs, Light Duty Trucks and Vans
- Safely Holds Oils, Fuel (Gasoline, Diesel, Biofuels), Brake Fluid, Antifreeze and Other Hazardous Fluids. (Not Intended for Storing Fluids)



**1 Pack**  
SKU 1089033  
SURFC5  
**29<sup>99</sup>**

**2 Pack**  
SKU 1245617  
SURFC5PK2  
**39<sup>99</sup>**

REG. \$59.98

**SAVE OVER \$19**

When You Buy the 2 Pack



### Torque Limiting Adapter for Oil Filter Canister Caps

SKU 1580932 **29<sup>99</sup>**  
87118

- 3/8" Drive Adapter Limits Torque to 25 Nm (18 Ft. Lb.)
- Prevents Over Tightening and Damage to Plastic and Metal Oil Filter Caps
- Can Also Be Used with a 21 mm Socket or Wrench for Limited Access Areas



### Swivel Oil Filter Wrench

SKU 1125870 **9<sup>99</sup>**  
87115 REG. \$14.99

- Fits Oil Filters 4-3/4" to 5-3/4"
- 1" Wide Stainless Steel Band

**SAVE \$5**



Offer Good While Supplies Last Through June 30, 2026



### Auto Fit Filter Pliers

SKU 1339727 **16<sup>99</sup>**  
87164

- Suitable for Filters with 2.4" to 5" Diameters
- Long Reach Slip Joint Design
- Precision Machined Jaw
- Non-Slip Comfort Grip



### Wide Range Filter Wrench

SKU OSB **14<sup>99</sup>**  
87162

- Fits Standard Sizes from 3-1/8" to 3-7/8"
- Designed for an Exact Fit to Prevent Slipping
- Use with a 3/8" Drive



For OSB, Call 901-300-4878

### 3 Jaw Adjustable Filter Wrench

SKU 1339734 **14<sup>99</sup>**  
87160

- Works on a Variety of Vehicles
- Fits Oil Filters 2-1/2" to 4-1/2" (63.5 mm to 114 mm)
- Fits 3/8" Drive Ratchets and Extensions
- Perfect for Removing Hard to Reach Filters



### 3 Jaw Adjustable Magnetic Oil Filter Wrench

SKU 908387 **14<sup>99</sup>**  
25101

- Oil Filter Diameter: 2.4" to 3.6" (60 mm to 93 mm)
- Secure Magnetic Attachment
- Spring-Loaded Legs for a Secure Grip
- Includes 3/8" to 1/2" Drive Adapter



### 4 Piece Swivel Oil Filter Wrench Set

SKU 1414418 **31<sup>99</sup>**  
87117

- Fits Oil Filters 2-3/8" to 2-7/8", 2-7/8" to 3-3/8", 3-3/8" to 3-3/4" and 3-3/4" to 4-3/8"
- Dimpled Band with 3 Sets of Grippers to Hold Filter Securely in Place
- 1" Wide Stainless Steel Band for a Strong Grip and Slip Resistance
- Rubber Cushioned TPR Grip for Comfort and Safety in Tight Places
- Includes OEMTOOLS 87111, 87112, 87113 and 87114



### 4-in-1 Steel Oil Filter Wrench

SKU 1189097 **9<sup>99</sup>**  
87116

- 4 Interchangeable Swivel Bands
- Size Range 2-3/8" to 4-3/8" (60.3 mm to 111.1 mm)
- 1 Swivel Handle with 4 Stainless Steel Bands
- Bands are Easily Removed and Installed



### 2-3/8" to 5" Oil Filter Pliers

SKU 757057 **29<sup>99</sup>**  
25324

- Removes Stubborn Oil Filters from Gas or Diesel Engines
- Long Reach Slip Joint Design
- Precision-Machined Jaw
- Non-Slip Comfort Grip
- 14" Length



### 2-1/2" to 4-5/8" Oil Filter Pliers

SKU OSB **14<sup>99</sup>**  
25320

- 20° Jaw Bend for More Applications
- Jaw Teeth for Sure Grip
- 12" Length



For OSB, Call 901-300-4878

### Heavy Duty Oil Filter Strap Wrench

SKU 1544663 **22<sup>99</sup>**  
87119

- For Use with 3/8" or 1/2" Drive Tools
- Fits Oil Filters Over 8" in Diameter
- Heavy Duty 27" Nylon Strap



### 15" Chain Wrench

SKU 452624 **54<sup>99</sup>**  
22659

- Great for Stubborn Oil Filters
- Designed for Tight Spaces
- Double-Action Allows Use in Either Direction
- Capacity: 5-1/2" Diameter
- 15" I-Beam Handle



### Heavy Duty Truck Oil Filters

- Extra Wide Band for Secure Grip
- 1/2" Drive Tools



SKU	Part #	Range	Price
344322	25231	4-1/8" to 4-5/8" (104 to 118 mm)	<b>34.99</b>
344323	25232	4-5/8" to 5-1/4" (118 to 134 mm)	<b>34.99</b>
344324	25233	5-1/4" to 5-3/4" (134 to 142 mm)	<b>39.99</b>



### Oil Filter Plug for Cummins

SKU 1340221 **7<sup>99</sup>**  
87168

- Perfect Tool for Installing and Removing Oil Filters
- Compatible with Dodge 6.7 Diesel Engines
- Prevents Oil Leaks When Removing Oil Filters from Engines
- Hard Plastic Construction for Maximum Strength and Durability
- Wide U-Shaped Handle for Added Grip and Control



# OIL CHANGE

## Cap Style Filter Wrenches

OEM TOOLS®

### Toyota/Lexus Oil Filter Cap Wrench Set

SKU 383457 **37<sup>99</sup>**  
25409

- Sizes: 64 mm, 73 mm and 74 mm
- Comes in Sturdy Blow Mold Case



### 9 Piece Oil Filter Cap Wrench Set

SKU 255627 **109<sup>99</sup>**  
27199

- Includes: 5 Chrome Plated Aluminum Wrenches (64.5 mm - 14 Flute Toyota, 64.5 mm - 14 Flute Toyota/Lexus, 88.8 mm - 15 Flute Hyundai/Kia, 74.2 mm - 14 Flute European, 86.6 mm - 6 Flute European), (1) 63 mm to 83 mm Adjustable Filter Wrench for Universal Applications, 3 Forged Low Profile Oil Filter Sockets (27 mm, 32 mm and 36 mm) and 3/8" Drive Application Chart for Quick Reference
- Comes in Sturdy Blow Mold Case



### 10 Piece Metric Cap Wrench Set

SKU 1189096 **39<sup>99</sup>**  
87151

- Painted for Rust Resistance
- Includes: 65/67 mm - 14 Flutes, 80 mm - 15 Flutes, 68 mm - 14 Flutes, 86 mm - 16 Flutes, 74/76 mm - 15 Flutes, 93 mm - 15 Flutes, 76 mm - 14 Flutes, 93 mm - 36 Flutes, 76 mm - 30 Flutes, 100 mm - 15 Flutes
- Comes in Sturdy, Green Blow Mold Case



Make	SKU	Part #	Size	Price	
Toyota/Lexus	OSB	25412	64mm - 14 Flutes	<b>13.99</b>	
BMW/Volvo	255675	25453	86.6 mm - 16 Flutes	<b>15.99</b>	
Hyundai/Kia	255659	25454	88.8 mm - 15 Flutes	<b>15.99</b>	
Toyota/Lexus	255634	25451	64.5 mm - 14 Flutes	<b>16.99</b>	
Toyota/Lexus	1340227	87131	64.5 mm - 14 Flutes	<b>7.99</b>	
Mercedes-Benz, Sprinter, VW, Audi, Porsche, Mazda	1340230	87132	74.2 mm - 14 Flutes	<b>9.99</b>	
Mazda/Ford	1340228	87133	75.6 mm - 14 Flutes	<b>10.99</b>	
Chrysler	1340234	87134	84 mm - 14 Flutes	<b>16.99</b>	
Volvo	1340237	87136	88.8 mm - 15 Flutes	<b>20.99</b>	
Land Rover	1340238	87137	90 mm - 15 Flutes	<b>21.99</b>	

For OSB, Call 901-300-4878

## Drain Plug Tools

OEM TOOLS®

### 14 Piece Drain Plug Socket Set

SKU 818568 **43<sup>99</sup>**  
25374

- Designed for Both Foreign and Domestic Vehicles Including: BMW, Ford, Mazda, Mercedes-Benz, Nissan, Peugeot, Renault and More
- Ideal for Removal of Oil Drain Plugs from Manual Transmissions, Transfer Cases, Differential Housings and More
- Includes Hex: 9, 10, 12, 14 and 17 mm; Square: 7, 8, 11, 13 mm, 5/16", 3/8"; Female Square: 10 mm; Male Triangle: 10 mm; Tamper-Proof Triple Square: 16 mm



### 8-in-1 Oil and Lube Multi-Wrench

- Designed to Fit Most Oil Drains, Transfer Case and Differential Plugs
- Features Offset Head Design with Yoke Support for High Torque Applications



SKU 1442594  
CTA2495K  
**49<sup>99</sup>**

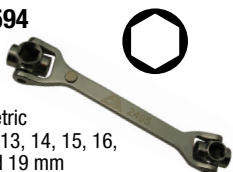

- 6 Point Metric
- Sizes: 12, 13, 14, 15, 16, 17, 18 and 19 mm

SKU 1442585  
CTA2497K  
**57<sup>99</sup>**

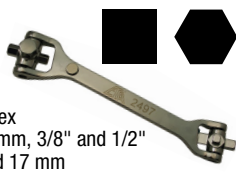

- Male Square and Hex
- Square: 8 mm, 10 mm, 3/8" and 1/2"
- Hex: 10, 12, 14 and 17 mm

### 3 Piece Plastic Oil Drain Plug Removal Set

SKU 1207894 **12<sup>99</sup>**  
25098

- Safely and Easily Removes Plastic Oil Drain Plugs on Late Model Ford, Volkswagen, BMW and Audi Cars
- 3/8" Drive
- Does Not Cause Damage to the Plug



### Plastic Oil Drain Plug Removal Set

SKU OSB  
SURDPR350 **69<sup>99</sup>**

- Releases Late Model Plastic Oil Pan Drain Plugs without Damage for Audi/BMW/Ford/Lincoln/VW



For OSB, Call 901-300-4878

## Oil Filter Sockets

OEM TOOLS®

### 7 Piece Oil Filter Removal Socket Set

SKU 191682 **41<sup>99</sup>**  
27197

- 3/8" Drive
- Includes: 24 mm for Cadillac; 27 and 36 mm for Mercedes-Benz, VW, Cadillac, Buick, Saturn, SAAB; 29 mm for Dodge Cummins Fuel Filter; 30 mm for Korean Cars; 32 mm for GM, Saturn and SAAB; 35/36 mm for Ford Diesel, MINI, BMW and Mack; 38 mm for Vauxhall Vectra
- Comes in Sturdy, Green Blow Mold Case



### 7 Piece Offset Oil Filter Cap Wrench Set

SKU 1145990 **27<sup>99</sup>**  
87165

- 3/8" Drive Set Includes: 24 mm for Cadillac; 27 and 36 mm for Mercedes-Benz, VW, Cadillac, Buick, Saturn, Saab; 29 mm for Dodge Cummins Fuel Filter; 30 mm for Korean Cars; 32 mm for GM, Saturn and SAAB; 35/36 mm for Ford Diesel, MINI, BMW and Mack; 38 mm for Vauxhall Vectra
- Comes in Sturdy, Green Blow Mold Case



### 3/8" Drive

- Use with a 3/8" Drive Chrome Plated

### 27 mm Socket

SKU OSB **10<sup>99</sup>**  
87171

### 32 mm Socket

SKU OSB **11<sup>99</sup>**  
87173

### 36 mm Socket

SKU OSB **16<sup>99</sup>**  
87174

### 36 mm Oil Filter Socket for 6.0L Ford Diesel

SKU 110279 **9<sup>99</sup>**  
25411

For OSB, Call 901-300-4878

### 3 Piece Low Profile Oil Filter Socket Set

SKU 094803 **18<sup>99</sup>**  
27204

- Includes: 27, 32 and 36 mm
- 3/8" Drive



## No Spill Oil Funnels

### Universal No-Spill Oil Funnel Set

SKU 1533126 **15<sup>00</sup>**  
87025

- Mounts Directly to Vehicle's Oil Fill Port for Spill-Free Oil Changes
- Includes 12 Adapters and 2 Extensions to Cover Most Engine Types
- No-Spill Adapters are Threaded to Securely Fit Filler Necks and Eliminate Oil Spills
- Funnel Can Support an Inverted Quart of Oil
- Transparent Funnel with Embossed Scale Lets You Easily Monitor Fluid Levels



STORE STOCKED

### Universal Direct Fit No Spill Oil Funnel Set

SKU 824884 **84<sup>99</sup>**  
87039

- Set Includes: Universal Oil Funnel, Chrysler (87019), Ford/Mazda (87020), GM (87021), Honda (87022), Toyota/Lexus (87024), Subaru Adapter, Toyota/Lexus Adapter and 150° Extended Adapter (87027) and Storage Rack
- Funnel Screws Directly into Filler Neck
- Threaded to Fit a Range of Import and Domestic Vehicles Older and Current Models
- Transparent Lower Chamber to Monitor Oil Flow
- Wide Passage for Rapid Refilling



OEM TOOLS®

Includes Wall Mount Bracket and Drip Tray



### Fast-Clamp Universal Oil Funnel

SKU 825017 **33<sup>99</sup>**  
87037

- Automatically Adjusts to Filler Neck
- Securely Clamps into Filler Neck; No Need to Hold Funnel in Place During the Refilling Process
- Transparent Lower Chamber to Monitor Oil Flow
- Clamp Can Be Used with Standard Funnels



### Direct Fit Individual Funnels



SKU	Part #	Description	Price
824892	87019	Chrysler, Dodge and Jeep	<b>19.99</b>
824879	87021	GM and BMW	<b>17.99</b>
824890	87022	Honda	<b>31.99</b>
824888	87023	Subaru	<b>34.99</b>
824886	87024	Toyota, Lexus, VW and Mercedes	<b>22.99</b>

## Dispensers

### 8 Quart Dispenser Lid and Cap

SKU 080078 **34<sup>99</sup>**  
LIS19702

- Spout Cap and Lid to Keep Out Contaminants
- Many Large SUVs and Trucks Now Require More Oil



Lisle

### 10 Quart Oil Jug

SKU 605325 **39<sup>99</sup>**  
87018

- Safe for Automotive Oils and Fluids
- Convenient Carry and Pour Handles
- Spill Proof Caps



OEM TOOLS®

### Flexible Spout Measuring Cans

- Designed for One-Hand Operation
- 14" Flexible Spout with Tapered Tip
- Recessed Bottom Drains Fully and Guards Against Punctures
- Rolled-Edge Top Helps Prevent Spilling

5 Quart  
SKU 298486  
LING525

**64<sup>99</sup>**

8 Quart  
SKU 298473  
LING528

**74<sup>99</sup>**



LINCOLN

## Oil Funnels

### Short Vortex Funnel

SKU OSB **2<sup>99</sup>**  
87307

- Innovative Vortex Design Vents Air While Pouring to Increase Flow for Fast, Clean, Consistent Pours
- Integrated Splash Guard and Bottle Support Help Reduce Spills and Mess
- Triangular Body Seats Securely in Round Fill Ports to Minimize Tipping
- Compact 5.8" Height with 4" Opening and 175 mL C
- Size: 5" D x 4" W x 5.8" H
- Spout Width: 1.15"
- Made in the USA For Dependable, Professional-Grade Performance



OEM TOOLS®

NEW



For OSB, Call 901-300-4878

## Drain Pans

### 16 Quart Oil Drain Pan

- Heavy Duty Polyethylene Construction
- Features a Pour Spout and No-Splash Lip



Green  
SKU 908389  
87034

**27<sup>99</sup>**

Black  
SKU 908382  
87033

**27<sup>99</sup>**

### 2.8 Quart Low-Profile Oil Drain Pan

SKU 568474 **11<sup>99</sup>**  
87017

Great for Motorcycles and Small Engines



### 4.7 Quart Clear Oil Drain Pan

SKU 568469 **9<sup>99</sup>**  
87013

- Built-In Level Scale Lets You See Fluid Level



Great for Transmission Fluid Changes

### 4.5 Gallon Black Oval Drain Pan

SKU 1142687 **49<sup>99</sup>**  
LIS17972

### 4.5 Gallon Green Oval Drain Pan

SKU 1142342 **49<sup>99</sup>**  
LIS17982



Lisle

### Oil and Transmission Funnel

SKU 547009 **16<sup>99</sup>**  
87008

- Both Straight and 45° Angle Screen to Prevent Debris from Entering Transmission
- Includes: Screen and Dust Cap
- Length: 25"

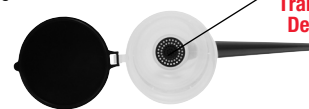

Filter to Keep Transmission Debris Free



OEM TOOLS®

### Offset Funnel with Spout Cap and Lid

SKU 1544662 **21<sup>99</sup>**  
LIS18232

- 10" Tall Translucent Funnel with a 6-3/4" Offset from Center of Mouth to Center of Spout
- Lid and Spout Cap Help Keep Funnel Contaminant Free
- Includes: Offset Funnel with Cap and Lid, Adapter for Transmission and Other Dipstick Tubes



Lisle

# FLUID HANDLING

## Fluid Extractors

Change fluids quickly and easily anytime. No mess, no clean up.  
Simply remove the dipstick and insert the tube.

**OEM TOOLS**

All OEMTOOLS Fluid Extractors Include:



- Single Piece Reservoir Structure Features a Leak Proof Bottom
- Overflow Shut Off Valve Prevents Fluid from Overflowing
- Use to Extract Most Fluid Types: Engine Oil, Transmission Fluid, Gear Oil, Coolant and Power Steering Fluid
- Updated 41" Extended Dipstick Hose Adapter for Longer Reach and Broader Applications

### Manual Fluid Extractors

- Reservoir with Hand Operated Pump to Tackle Big Jobs



**1.4 Gallons (5.6 Qts.)**  
SKU 544744 24389 **129<sup>99</sup>**

**2.1 Gallons (8.4 Qts.)**  
SKU 666877 24936 **144<sup>99</sup>**

**2.5 Gallons (10 Qts.)**  
SKU 547010 24397 **178<sup>99</sup>**

### Pneumatic/Manual Fluid Extractors

- Working psi: 85; Max. psi: 120
- Air Consumption: 6.5 CFM



**1.5 Gallons (6.3 Qts.)**  
SKU 666978 24937 **163<sup>99</sup>**

**2.5 Gallons (10 Qts.)**  
SKU 666881 24938 **149<sup>99</sup>**

### Brake Bleeder Adapter Hose for Fluid Evacuators

SKU 568479 24446 **28<sup>99</sup>**

- Use with OEMTOOLS Fluid Evacuators, Converting Them into One-Person Vacuum Brake or Hydraulic Clutch Bleeders
- Universal Bleed Screw Adapter



### Replacement Dipstick and Tube Adapter

SKU 1442595 24938-2 **22<sup>99</sup>**

- 1/4" x 17" PVC Hose



### Main Suction Hose Replacement

SKU 1442592 24938-1 **29<sup>99</sup>**

- Replacement for OEMTOOLS 24938, 24937, 24397, 24389 and 24936



## Fluid Evacuators

### Fluid Evacuator (1.9 Gallon)

SKU 594882 24446 **154<sup>99</sup>**

- Integrated 1.9 Gallon (7.3 Liter) Capacity Reservoir
- Evacuates All Kinds of Fluids Including Engine Oil, Transmission Fluids, Gear Oil, Coolant, Brake Fluid and More



### PneumatVac Fluid Evacuator (2.3 Gallon)

SKU 497203 24446 **179<sup>99</sup>**

- Operates on Compressed Air
- Independent Air Shut-Off Valve



### Fluid Evacuator Plus

SKU 497200 24446 **184<sup>99</sup>**

- Evacuates or Dispenses at the Push of a Button
- Integrated 2.3 Gallon (8.8 Liter) Capacity Reservoir
- Durable, Chemical Resistant Polyethylene Construction
- Dipstick Tube Adapters Included



**Mityvac**

## Fluid Extractors and Fillers

**Mityvac**

### 1.5 L Fluid Extractor/Dispenser

SKU 606541 24446 **89<sup>99</sup>**

- Simple Manual Syringe-Type Action Quickly and Cleanly Extracts or Dispenses Fluid
- Integrated Valve and Cap to Prevent Spills and Leaks
- Compact, Streamlined Design Allows Access into Tight Spaces
- Ideal for Evacuating or Topping Off Fluid Reservoirs
- Easy to Clean; Hose and Seals are Simple to Replace



### 1.5 L Fuel Extraction Syringe

SKU OSB 24446 **109<sup>99</sup>**

- Ideal for Evacuating or Priming Diesel Fuel Systems
- 2 Adapter Hoses: 10 mm Male to 3/8" or 5/16" Female Fuel System Connections
- 3 Male-to-Male Adapters: 10 mm Male to a Barbed, 3/8" or 5/16" Male Connection

For OSB, Call 901-300-4878



### Fluid Siphon Pump

SKU 568475 24863 **31<sup>99</sup>**

- Easily Transfers Gas, Water, Oil and Other Non-Corrosive Liquids
- Hose Reach: 6' with 1/2" Diameter



### 500 cc Fluid Extractor and Filler

SKU 1544658 25572 **23<sup>99</sup>**

- Use to Extract and Refill Many Common Automotive Fluids, Including Brake Fluid
- Dual Scale Molded into Cylinder Body (Qt/mL)
- Translucent Cylinder Body to Easily Read Volume Extracted and Fluid Condition
- 500 cc Volume and Suction Tubes Enable Faster, More Efficient Fluid Transfer



### Transmission Fluid Fill Adapter

SKU 1125880 25740 **5<sup>99</sup>**

- Required Tool to Fill or Add Fluid to the 5R55W Automatic Transmission
- Used in Many Ford Vehicles (2003 - Newer) Same as Ford No. 307-437



## Fluid Management



### ATF Refill Kit, 5 L

SKU **OSB**  
MITMV6410A **484<sup>99</sup>**

- Fluid is Dispensed Under Pressure for Smooth Continual Flow
- Integrated Manual Pump Adds Air Above the Fluid Level to Prevent Aeration
- Internal Pump Components are Sealed Against Exposure to Fluids
- Flow Control Valve is Conveniently Located Near Fluid Output
- Features Integrated Safety and Manual Pressure Relief Valve



For OSB, Call 901-300-4878

### Pneumatic ATF Refill Kit, 10 L

SKU 1330680  
MITMV7412 **524<sup>99</sup>**

- Utilizes Compressed "Shop-Air" to Produce Pressure for Fluid Dispensing



### ATF Refill Adapters with Hose

SKU 1361999  
MITMV7216A **264<sup>99</sup>**

Quickly Converts the Mityvac MITMV7201 Fluid Evacuator Plus into a Professional Tool for Refilling Sealed Automatic Transmissions

- 13 Quick-Change ATF Refill Adapters Fit Most Vehicle Transmissions



### Pneumatic Powered Gear Oil Dispenser

SKU 1544685  
MITMV7454 **439<sup>99</sup>**

- 10 Liter Pneumatic Pump Gear Oil Dispense Bottle with Low Restriction Hose, Valve and Nozzle
- Powered by Compressed Air
- 10 Liter Reservoir for Larger Dispensing/Longer Refill Intervals
- Can be Pressurized and Disconnected from Compressed Air Source for Convenience
- Easily Replaceable Tubing for Repair or Customization of Unit to Job Requirements



### Hand Pump Powered Gear Oil Dispenser

SKU 1544672  
MITMV7455 **329<sup>99</sup>**

- 10 Liter Hand Pump Gear Oil Dispense Bottle with Low Restriction Hose, Valve and Nozzle
- 10 Liter Reservoir for Larger Dispensing/Longer Refill Intervals
- Hand Pump Supplies Compressed Air to Power Unit
- Manual Pump to Compress Air; Nothing but Pressurized Air Moves Fluid which Lessens Risk of Contamination
- Fluid Level Indications on Reservoir to Monitor Fluid Levels



### Manual ATF Filler System

SKU 526508  
24441 **139<sup>99</sup>**

- Complete System for Servicing Sealed Automatic Transmissions
- Includes Adapters to Fit Ford, BMW, Honda, Nissan, VW, Porsche, MINI, Audi and Mercedes-Benz
- Transmissions Reservoir Capacity: 3 Liters (3.1 Quarts)
- Adapters Included:
  - DSG M24 x 1.5,
  - CVT M22 x 1.5,
  - CVT M12 x 1.5,
  - ATF M10 x 1.0,
  - ATF 1/8 NPT - 27,
  - ATF 04, ATF 03 and ATF 02



### Universal Fluid Dispensing System

SKU 265093  
MITMV6400 **254<sup>99</sup>**

- Large 1.2 Gallon (5 Liter) Fluid Capacity
- Integrated Manual Pump Adds Air Above the Fluid Level to Prevent Aeration
- Pressure Gauge Indicates Fluid Dispensing Pressure
- Safety and Manual Pressure Relief Valve
- Vehicle Adapters Not Included



### DEF Fluid Extractor 1.5 L

SKU 1089032  
LIN617 **84<sup>99</sup>**

- Integrated Valve and Cap to Prevent Spills and Leaks
- Ideal for Evacuating or Topping Off DEF Reservoirs
- Simple Manual Syringe-Type Action Extracts or Dispenses DEF Quickly
- Disassembles Easily for Cleaning
- 16" Clear Hose is DEF Compatible



### Battery-Operated Liquid Transfer Pump

SKU 1414413  
87230 **15<sup>99</sup>**

- Move Liquids Safely and Easily with this Convenient Handheld Pump
- Use in Garage, Aquariums, Home and Yard
- Pumps Up to 6 Quarts of Liquid per Minute
- Battery Operated (2 "D" Batteries)

Great for Use with Generators



# FLUID HANDLING

## Lever Action Pumps

**OEM TOOLS**

### Lever Action Hand Oil Pump

SKU 462495 **42<sup>99</sup>**  
24381

- Oil Pump for Use with Oil-Based Fluids, Heating Oils, Motor Oils, Heavy and Light Oils, Diesel and Kerosene
- Built-In 1-1/2" and 2" Bung for Use on 16 to 55 Gallon Drums with Either Opening
- Not for Gasoline or DEF



**OEM TOOLS**

### Lever Action Barrel Pump - Polypropylene

SKU 688036 **69<sup>99</sup>**  
24471

- Lever Action Pump, Self-Priming
- Ideal for Diesel, Kerosene, Lubricants and Other Oils
- Not for Gasoline, Water Based Chemicals or DEF
- Maximum Flow Rate: 12 Oz. per Stroke
- Maximum Viscosity: 40 Wt. Oil



**OEM TOOLS**

### Lever Action Barrel Pump Polypropylene Stainless Steel Rod

SKU 688038 **59<sup>99</sup>**  
24472

- Ideal for Pumping Diesel, Oils, Kerosene, Water-Based Chemicals, Bases and Mild Acids
- Not for Gasoline or DEF



**OEM TOOLS**

### Lever Action Barrel Pump - Ryton® Stainless Steel Rod

SKU 688037 **89<sup>99</sup>**  
24473

- Ideal for Pumping Diesel, Oils, Kerosene, Water-Based Chemicals, Bases and Acids Including DEF
- Not for Gasoline

**DEF COMPATIBLE**



**LINCOLN**

### Lever Action Barrel Pump

SKU 970530 **99<sup>99</sup>**  
LIN1340

- Pumps Non-Corrosive Fluids, Not for Gasoline
- Telescoping Tube for 16 to 55 Gallon Drums
- Removable Non-Drip Spout Allows for Threaded Hose Connection



## Rotary Pumps

**OEM TOOLS**

### Rotary Barrel Pump

SKU 462486 **54<sup>99</sup>**  
24382

- Fluid Transfer Pump for Use with Oil-Based Fluids, Heating Oils, Motor Oils, ATF, Diesel and Kerosene
- Not for Gasoline or DEF



**OEM TOOLS**

### Polypropylene Rotary Drum Pump

SKU 688035 **129<sup>99</sup>**  
24470

- Ideal for Pumping Diesel, Oils, Kerosene, Water-Based Chemicals, Bases and Mild Acids
- Not for Gasoline or DEF



### Manual Rotary Oil Pump with Hose for 55 Gallon Drums

SKU 265089 **349<sup>99</sup>**  
LIN1385H

- Includes: 8 Ft. x 3/4" Anti-Static Hose with Non-Sparking Aluminum Nozzle with Hanger; Seal Tight Telescoping Pick-Up Tube with Strainer for 16 to 55 Gallon Drums with 2" Bung



**LINCOLN**

### Manual Rotary Fuel Pump with Hose for 55 Gallon Drums

SKU 265088 **394<sup>99</sup>**  
LIN1387

- 3 Vane Manual Rotary Pump for Most Fluid Types Including Gasoline, Diesel, Kerosene, Coolant, Non-Corrosive Materials, Medium Viscosity Petroleum Based Fluids, Hydraulic Oils and ATF



**LINCOLN**

### Manual Rotary Pump for 55 Gallon Drums

SKU 462977 **264<sup>99</sup>**  
LIN1385

- Hose Not Included

Drum Not Included

## Drum Wrench

**OEM TOOLS**

### Aluminum Drum Bung Wrench

SKU 1267963 **28<sup>99</sup>**  
22664

- Comfortable and Textured Grip for Ease of Use
- Non-Sparking, Non-Corrosive Aluminum Construction
- Fits Most Steel and Plastic Caps, Including 3/4" Vent Plugs
- Effortlessly Opens and Tightens Bungs to Guarantee Drum Contents are Safe
- Opens 10, 15, 20, 30 and 55 Gallon Barrels



## Fuel Transfer Pump

**JD JohnDow Industries**

### 25 Gallon Steel Gas Caddy

SKU 360585 **1,079<sup>99</sup>**  
DOWFC25GC

- UL Approved
- 25 Gallon Tank is Constructed of 14" Gauge Steel for Use with Unleaded Gasoline, Kerosene, Ethanol E85, Diesel and Bio-Diesel Fuels



## DEF Pump

**LINCOLN**

### Lift Action Pump

SKU 1142361 **174<sup>99</sup>**  
LIN1390

- Transfers Popular Shop Fluids Including Acetone, Antifreeze, Windshield Washer, Thinners and More
- Includes NPT and Buttress Threads for Steel and Plastic Drums
- Adjustable Bung Type Fits 15, 16, 30 and 55-Gallon Drums
- Welded Ground-Post for Safe Dispensing of Volatile Fluids
- Premium Grade 316 Stainless Steel
- Self-Priming

**DEF COMPATIBLE**



## Grease Pump

**LINCOLN**

### Manual Gear Lube Dispenser

SKU 174166 **154<sup>99</sup>**  
LIN1293

- 5' Hose, 13" Pump Tube
- Fits 25 to 50 Lb. 5 Gallon Containers
- Delivers 1 Oz. per Stroke



## Lube Tech Set **OEM TOOLS**

SKU 227302 | 24965

**1,899<sup>99</sup>** REG. \$2,252.39

**SAVE \$352**

**Includes 160 of the Most Common Tools in Tool Cart**

- SAE and Metric, 1/4", 3/8" Drive Tools, Combination Wrench Sets, Pliers and Screwdrivers. Plus Battery Service Tools, Oil Change Tools and More



Go to [AZTOOL1.com](http://AZTOOL1.com) for 24965 Contents List

Offer Good Through June 30, 2026

Cart Style and Color May Vary

## Oil and Grease

### Oil Control Handle with Digital Meter

SKU 1485049 **334<sup>99</sup>**  
BAL3330-159

- Exclusive "Memory" Flex Enables the Extension to Bend Into Any Desired Shape
- Replaceable Electronic Circuit Board and Face Plate
- Ergonomically Designed Grip Handle Reduces Fatigue for Technicians

### Electronic Preset Meter

SKU OSB **649<sup>99</sup>**  
BAL3331-032



### Lynx 3:1 Universal Stub Pump

SKU 1580956 **469<sup>99</sup>**  
BAL1110-007

- Reliable Air Motor Design that Features Corrosion Resistant Materials
- Double-Acting Pump Design for Smooth and Accurate Fluid Delivery
- Includes 2" Bung-Adapter



### 5:1 HD Oil Pump Drum Package

SKU OSB **2,449<sup>99</sup>**  
BAL1131-069

- Reliable Air Motor Design that Features Corrosion Resistant Materials
- Includes: Heavy-Duty Drum Cart with Semi-Pneumatic 10" Tires, Front Caster with Brake to Steady Cart While in Use, 50' x 1/2" Hose Reel and Electronic Metered Handle



Drum Not Included

### Lynx 55:1 Pump Package

SKU OSB **1,389<sup>99</sup>**  
BAL1151-036

- Reliable Air Motor Design that Features Corrosion Resistant Materials
- Double-Acting Pump Design
- Optional Hose Reel Mounting Kit

### Lynx 55:1 Portable Grease 120 Lb. Package

SKU OSB **954<sup>99</sup>**  
BAL1151-028



Inside View

Drum Not Included

## Used Fluid Drains



**Balcrank**  
Fluid Dispensing Systems

- All-Steel Tank and Base
- Easy-to-Use Patented Cantilever Mechanism

### 23 Gallon Oil Drain

SKU 1485039 **919<sup>99</sup>**  
BAL4110-024

- Powder-Coated Black
- 1" Cam-Lock Fitting

### 23 Gallon Anti-Freeze Drain

SKU 1485042 **909<sup>99</sup>**  
BAL4110-025

- Powder-Coated Green
- 3/4" Cam-Lock Fitting

Premium Drains Capture Used Fluids and Transfer Them to Any Bulk Storage Tank Using a Cam-Lock Kit and Evacuation System



BAL4110-024

## Filter Crusher

### Industrial 10 Ton Oil Filter/Can Crusher

SKU OSB **2,349<sup>99</sup>**  
RANRP20FC

- Reduces Used Oil Filters to 1/4 of the Original Size
- 20,000 Lb. Crushing Power
- 100% Air Operated for Minimal Maintenance
- Save on Disposal Costs and Storage Space
- Automatic Safety Door Stops Operation When Opened
- Pressure Regulator and Air Moisture Separator Come Standard
- Transparent Door for a Convenient View of the Crushing Process
- Welded Steel Plate Construction
- Exclusive X-Shape Bevel in Press Head Pre-Aligns Filters for Absolute Vertical Press



**INCLUDES STAND**

For OSB, Call 901-300-4878

## Used Oil Evacuation

- Includes: All Necessary Fitting, Brackets, Valves, Hoses and Components for Seamless Integration with Air System and Fluid Collection/Discharge Processes

### 3/4" Evacuation Package for Used Antifreeze

SKU 1485050 **1,919<sup>99</sup>**  
BAL1121-025

### 1" Evacuation Package for Used Oil

SKU 1485032 **1,989<sup>99</sup>**  
BAL1121-024

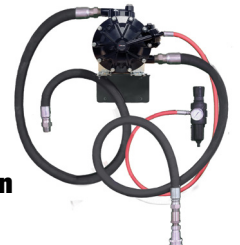

To Confirm Price, Availability and Ordering Instructions on OSB Call 901-300-4878

Prices subject to change without notice. Prices do not include applicable taxes, vehicles, tires, rims, installation or optional equipment as shown. Please do not return purchases to the store. For information regarding warranty, repair, or any questions or concerns, call 901-300-4878.

# FLUID HANDLING

## Fluid Exchangers

### Brake Flush Machine with Adapters

SKU **OSB**  
FLDBRKMATEJR **3,949<sup>99</sup>**

- 12V Pressure Exchanger and Brake Flush Machine
- 5 Qt New Tank with Low-Fluid Shutoff
- 1 to 59 psi Regulated Pressure Control
- Includes Master Cylinder Adapter Set
- Hybrid System Capable



**NEW**



### TSD 450 LCD Automatic Transmission Fluid Exchanger

SKU **OSB**  
FLDTSD450LCD **6,749<sup>99</sup>**

- Fully Automatic In-Line and Dipstick Exchange
- 24 Quart Tanks/Up to 21 Quart Exchange Capability
- LCD Screen Prompts with Quart Counter
- Add/Remove Fluid Buttons for Proper Level Control



**NEW**



### Heated Cooler Line Flusher, 10 Gallon

SKU **OSB**  
FLDGTECTCF8 **6,749<sup>99</sup>**

- Heated Flusher Helps Reduce Comebacks
- 10 Gallon Heated Steel Tank
- Oberg 64 Micron Filter Shows Removed Debris
- Extensive Adapter Coverage for Many Makes/Models
- Cleans Cooler Lines and Heat Exchanger Before Install



**NEW**



### ATX280 Trans Fluid Exchange Unit

SKU **OSB**  
MSS4008002300 **5,999<sup>99</sup>**

- 7" Touchscreen LCD Display with Graphical Interface
- Onboard Additive Tank for Detergent/Oil Injection



Fluid Not Included

**MAHLE**

### Trans-Tech 4 Plus

SKU **OSB**  
MVC500-1125B **5,699<sup>99</sup>**

- Automatic, In-Line Exchange Through Vehicle Cooler Line
- ATF Exchange Through Vehicle Transmission Dipstick
- Drain Pan Feature
- 26 Quart New Fluid Reservoir
- High Volume Pump for Rapid and Efficient Service
- Comes with Standard Set of Adapters
- Uses MVC400-0137 2-Part ATF Cleaner and Conditioner Fluid



Fluid Not Included

**MOTORVAC**

### BFX-20 Brake Fluid Exchanger

SKU **OSB**  
MSS4258001400 **2,429<sup>99</sup>**

- Hydraulic Pump
- Suitable for ABS, ESP, EDS and SBC
- Adapters Included



Fluid Not Included

**MAHLE**

### BFX-10 Brake Fluid Exchanger

SKU **OSB**  
MSS4258001600 **1,249<sup>99</sup>**

- Suitable for ABS, ESP, EDS and SBC
- Hydraulic Pump
- Two Universal Adapters Included



Fluid Not Included

**MAHLE**

### BrakeVac™ III Premium Brake Fluid Flush System

SKU **OSB**  
MVC500-8200 **1,479<sup>99</sup>**

- Exchanges DOT3, DOT4 and DOT5 Brake Fluids
- Pulsating Flow Helps Eliminate Air Issues
- Automatic Shut-Off When Source Brake Fluid is Empty
- One-Person Operation
- Includes: Brake Adapter Set



Fluid Not Included

**MOTORVAC**

To Confirm Price, Availability and Ordering Instructions on OSB, Call 901-300-4878

# COOLING SYSTEM

TO ORDER, contact your Commercial Sales Manager or go to [AutoZonePro.com](http://AutoZonePro.com)

COOLING SYSTEM

## Pressure Testers

OEM TOOLS®

### Universal Cooling System Adapter Set

SKU 434723 **59<sup>99</sup>**  
27067

- Designed to Fit Most Passenger Vehicles and Light Duty Trucks
- Fits Both Radiators and Plastic Reservoirs
- Universal Design Works with Any Cooling System Pressure Pump
- Prevents Damage to Plastic Reservoir Threads That Occurs When the Wrong Adapter is Forced On
- Pressure Test Pump Not Included

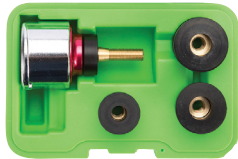

### Cooling System Pressure Test Pump

SKU 434722 **84<sup>99</sup>**  
27069

- Quickly and Easily Pressure Test Cooling Systems in Most Vehicles
- High Quality Pressure Pump Designed to Work with Most Cooling System Adapters
- Easy-to-Use Lever Style Pressure Relief Valve



### Universal Cooling System Pressure Test Kit

SKU OSB **119<sup>99</sup>**  
27068

- Quickly and Easily Pressure Test Cooling Systems in Most Vehicles
- Includes: 3 Expandable Adapters that Take the Place of Numerous Specialized Adapters
- Easy Lever Style Pressure Relief Valve
- Prevents Damage to Plastic Reservoir Threads that Occurs When the Wrong Adapter is Forced on



For OSB, Call 901-300-4878

### Heavy Duty Cooling Test and Refill Kit

SKU 954220 **129<sup>99</sup>**  
MSC43014

- Includes: Vacuum Gauge, Sealing Collar, Valve, Rubber Gaskets and Coolant/Draining Hoses
- Sealing Collar (with Rubber Cone) Offers a Wide Variety of Applications for Radiator Filler Necks
- Minimizes the Risk of Engine Overheating
- 2.3 Gallons per Minute Fill Rate



Mastercool®  
World Class Quality

### Heavy Duty Cooling Kit

SKU 954231 **514<sup>99</sup>**  
MSC43306

- Includes: Heavy Duty Vehicle Adapters, Pressure Test Regulator, Vacuum Refill Attachment with Tubing in a Plastic Case
- For Use with Freightliner, International, Kenworth, Peterbilt, Mack, Volvo, GMC and Sterling Cooling Systems
- Uses Shop Air to Pressure Check and Vacuum Refill
- 4 Quick-Disconnect Vacuum Attachments Provide Quick Refilling of the Cooling System and Eradicates Airlocks



Mastercool®  
World Class Quality

### 27 Piece Master Radiator Pressure Test Kit

SKU OSB **384<sup>99</sup>**  
MSC43301-A

- Includes: 1 Blue Radiator Cap Test Connector R123/R125, 1 Black Radiator Cap Test Connector R123/R124, 1 Thermometer, 1 Universal Radiator Cap, 1 Vacuum Purge and Refill Tool, Coolant Hose and Additional Installation Accessories, 1 Hand Pump and 19 Adapters (Nos. 2 to 4, 6 to 21) to Fit Most Popular Domestic and Import Cars and Trucks



For OSB, Call 901-300-4878

## Cooling System Adapters

### Volvo, Saab, Jeep, Maserati, Ferrari Radiator Adapter

SKU 133600 **44<sup>99</sup>**  
27241R

- Fits Maserati and Ferrari Models (2000 - Newer), Jeeps with Male Threads (1990 - 1994), Saab 900 (1978 - 1993), Saab 900 (Drop Top 1994), Saab 9000 (1987 - 1998), Volvos with Male Threaded Necks
- Diameter: 45 mm; Thread Size: 3 mm



### GM Radiator Adapter

SKU 133621 **44<sup>99</sup>**  
27118R

- Fits Many GM, Chrysler, Ford, Jaguar and Freightliner Models



### Audi and VW Radiator Adapter

SKU 133625 **39<sup>99</sup>**  
27245R

- Fits Audi A4 (1996 - Newer), A6 (1998 - Newer), A8 (1997 - Newer), S4 (2004 - Newer), TT (2000 - Newer), Bentley (2006 - Newer), Lamborghini (2006 - Newer), Porsche Cayenne (2003 - Newer), Porsche Panamera (2010 - Newer), Volkswagen Passat (1998 - Newer), Beetle (1998 - Newer), Golf and Jetta (1999 - Newer)



### Mercedes and Chrysler

SKU 133626 **39<sup>99</sup>**  
27246R

- Use with Any Standard Pressure Tester
- Fits Mercedes-Benz with Threaded Filler Necks (Except M-Class 1998 - 2005) and Chrysler Crossfire (2004 - 2008)
- Diameter: 62 mm
- Thread Size: 4 mm



### Mazda 3, Volvo S40/V50 and Ford Radiator Adapter

SKU 133633 **43<sup>99</sup>**  
27249R

- Fits Land Rover LR-2 (2008 - Newer), Mazda 3 (2004 - Newer), Volvo S40 and V50 (2004 - Newer), XC60 (2010 - Newer), Ford Fusion and Escape (2012 - Newer)
- Diameter: 50 mm; Thread Size: 2.5 mm



### Toyota, Lexus and Scion Radiator Adapter

SKU 133632 **42<sup>99</sup>**  
27248R

- Fits Lexus LS (2007 - Newer), Toyota Celica (2000 - Newer), Spyder MR2 (2000 - Newer), RAV4 (2009 - Newer), Prius (2004 and Newer), Camry (2007 - Newer), Highlander (2006 - Newer) and Scion XB (2008 - Newer)
- Diameter: 34 mm; Thread Size: 3 mm



### Ford, Jaguar, Pontiac, Range Rover and Saab Radiator Adapter

SKU 133611 **25<sup>99</sup>**  
27243R

- Fits Jaguar X Type (2002 - Newer), Saab 900 (1994 - 1998), Saab 9-3 and 9-5 (1999 - Newer), Some Saturns and Other Vehicles
- Diameter: 52 mm; Thread Size: 3 mm



### VW Radiator Adapter

SKU 133609 **34<sup>99</sup>**  
27242R

- Volkswagens with Female Threaded Filler Necks (1990 to 1998)
- Diameter: 57 mm; Thread Size: 3 mm



### Ford, Jaguar and Mazda Radiator Adapter

SKU 133631 **31<sup>99</sup>**  
27247R

- Ford Contour 1998-2000, Jaguar XJ8 1998-Up, Jaguar XK8 1997-2006, Mazda Tribute 2001-Up
- Diameter: 52 mm; Thread Size: 3 mm



Prices subject to change without notice. Prices do not include applicable taxes, vehicles, tires, rims, installation or optional equipment as shown. Please do not return purchases to the store. For information regarding warranty, repair, or any questions or concerns, call 901-300-4878.

AZG0226

# COOLING SYSTEM

## Coolant Funnels

### Professional No-Spill Coolant Funnel Kit

SKU 943142 **31<sup>99</sup>**  
87043

- 5 Spring-Loaded Adapters for a Secure Fit
- Simply Select the Correct Adapter, Attach the Funnel and Fill
- Air-Release Tubes to Vent the System During Refilling Process
- Stopper Prevents Dripping When Removing the Funnel
- Includes: Extensions and Adapters for Hard-to-Reach Surge Tanks



OEM TOOLS®

### No-Spill Coolant Filling Funnel Kit

SKU 802197 **19<sup>99</sup>**  
87007

- 4 Radiator Cap Adapters to Fit Most Passenger and Light Trucks
- Simply Select Correct Adapter, Thread Together, Attach the Funnel and Fill
- Rotary Switch to Effectively Prevent Drips and Spills, and Stop Overflow and Bubbles
- Includes: 5 Adapters, (2) 45° Elbows and (2) 5" Extension Rods for Difficult-to-Reach Areas



### Drip-Free Funnel for Automotive Fluids

SKU 1142569 **37<sup>99</sup>**  
87041

- Designed for Easy Refilling of Automotive Cooling Systems and Other Automotive Fluids
- Funnel Features a Fluid Stopper to Prevent Drips when Removing the Funnel
- Includes: (2) 45° Angled Adapters and 5" Extension for Accessing Hard-To-Reach Spots



## Leak Tester

OEM TOOLS®

### Gas Engine Combustion Leak Tester

SKU 1103608 **25<sup>99</sup>**  
37145

- Used to Test for Combustion Leaks That Result from Head Gasket, Cylinder Head and Engine Block Leaks
- Pulls Air from the Cooling System Up Through the Leak Tester; if Carbon Dioxide is Present, the Leak Tester Fluid Color Will Change to Yellow Signifying a Combustion Leak



### Combustion Leak Detector Fluid (8 Oz.)

SKU 391381 **9<sup>90</sup>**  
25739

- Test for Internal Combustion Leaks on Gasoline Engines Fluid Turns Yellow When Exhaust Gases are Present in Cooling System
- Designed for Use with 37145 Combustion Leak Detector (Not Included)
- Can Be Used with Other Combustion Leak Testers, See Manufacturer's Manual Prior to Use
- Not for Use with Diesel Engines



STORE STOCKED

STORE STOCKED

## AirEvac Cooling System

### AirEvac Cooling System Refiller

SKU 568478 **135<sup>99</sup>**  
24444

- Quickly Refills Cooling System and Eliminates Trapped Air
- Helps Prevent Come-Backs and the Threat of Engine Damage
- Universal Adapter Forms an Airtight Seal with Most Radiator and Coolant Bottle Necks
- Performs Vacuum Leak Tests
- Covers Most Radiator and Reservoir Types
- No Custom Adapters Required
- Comes in Sturdy, Green Blow Mold Case



### AirEvac Cooling System Kit

SKU 099292 **99<sup>99</sup>**  
27066

- Uses Shop Air to Evacuate the Cooling System for Vacuum Leak Testing
- Refills Cooling System without Trapping Air That Causes Overheating
- Universal Adapter Forms an Airtight Seal with Both Radiators and Coolant Reservoirs
- Self-Locking Quick Disconnects for Fast Assembly



OEM TOOLS®

## Flush Tools

### Cooling System Back Flush Tool

SKU 750008 **52<sup>99</sup>** REG. \$64.99  
24506

- Non-Corrosive Aluminum
- Easy to Use
- Connects to Standard Hose 1/2", 5/8" and 3/4" Hose Fittings
- Made of Non-Corrosive Aluminum



Offer Good Through June 30, 2026

SAVE \$12

### Coolant System Flush Gun

SKU 1284967 **59<sup>99</sup>**  
24719

- Universal Nozzle to Fit Various Radiator or Heater Hoses
- Combines Water with Compressed Air to Quickly and Efficiently Flush Cooling Systems
- Comfortable Lever-Action Air Throttle with Lock-On Latch for Simple Attachment of Air Hoses
- Used for the Detailed Flushing of Debris and Contaminants from the Cooling System During Repair and Maintenance



OEM TOOLS®

# COOLING SYSTEM

TO ORDER, contact your Commercial Sales Manager or go to [AutoZonePro.com](http://AutoZonePro.com)

COOLING SYSTEM

## Cooling System Tools

### 4 Piece 14" Jumbo Pick Set

SKU 94658  
25940 **43<sup>99</sup>**

- Includes: Straight Pick, 90° Pick, Offset Pick and Hook Pick



### Clic-R Hose Clamp Pliers

SKU 1089038  
25102 **9<sup>99</sup>**

- Easily Remove or Install Clic-R Type High Tension Clamps
- Heavy Duty and Durable Steel Construction
- Clamps Commonly Found on BMW, Mercedes-Benz, Audi, VW and Other Cars and SUVs



### 5 Piece Hose Remover Set

SKU 1335785  
26519 **18<sup>99</sup>**

- Dual Durometer Handles for Comfort and Grip
- Hooks and Picks are Assembled from Carbon Steel for Strength and Durability
- Perfect for the Removal of Coolant Hoses, Cotter Pins Brake Springs, Large Electrical Connectors and More

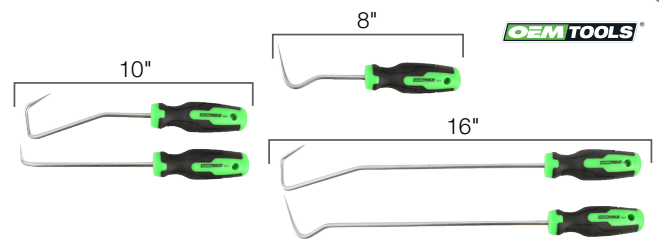

### 2.4 Gallon Plastic Radiator Filler

SKU 754738  
87104 **19<sup>99</sup>**

- Impervious to Oil, Gasoline and Antifreeze
- Stands Up to Extreme Weather



### Hose Clamp Pliers

SKU OSB  
25246 **26<sup>99</sup>**

- Removes and Installs Flat Band Spring Style Hose Clamps with Diameters of 11/16" to 2-1/2"
- Multi-Position Lock Holds Clamps Open for Hands-Free Operation
- Engineered For Maximum Strength



### Master Freeze Plug Installer Kit

SKU 965837  
27208 **115<sup>99</sup>**

- Designed to Remove and Install Freeze Plugs Used in Liquid-Cooled Gas and Diesel Engines



### Professional Series Ethylene Glycol Antifreeze Tester

SKU 750007  
24507 **14<sup>99</sup>**

- For Testing Hot or Cold Ethylene Glycol-Based Coolants, Including Dex-Cool®
- Easy-to-Read Discs are Magnified by Convex Design of the Clear, Thermal Resistant Plastic Barrel
- Disc-Type 16-1/4" Tester is Accurate at All Temperatures (Celsius and Fahrenheit Scales)



(Color May Vary)

### Water Pump Holding Tool

SKU OSB  
26060 **23<sup>99</sup>**

- Holds the Timing Chain and Gear in Place While Removing or Installing Water Pump on Ecotec Engines
- Securely Holds Water Pump Sprocket Preventing Loss of Timing or Damage to the Engine
- Special Half-Moon Design Allows Easier Access to Water Pump Gear Bolts
- Uses Access Cover Bolts to Hold the Tool in Place



To Confirm Price, Availability and Ordering Instructions on OSB, Call 901-300-4878

## Coolant Exchangers

### VCX-1 Vacuum Coolant Exchanger

SKU OSB  
MSS4708001900

**3,129<sup>99</sup>**

- Extremely Fast Service Cycles
- Simple Hook-Up and Operation
- Flexible Adaptation for Most Makes and Models



Coolant Not Included

### FluidPRO® MCX-2 Multi-Coolant System Fluid Exchanger

SKU OSB  
MSS4708003000 **3,229<sup>99</sup>**

- Includes System Pressure Test Feature and "Hot Car" Radiator Cap Pressure Release
- Compatible with All Coolant Types for Adaptability
- Contains (2) 7.5 Gallon New Coolant Tanks and (1) 15 Gallon Waste Tank Providing Simple, Rapid Switching from One Coolant to Another
- 3 Minute Service Time for Increased Productivity



Coolant Not Included

MAHLE

## Used Fluid Drain

Balcrank  
Fluid Dispensing Systems

### 23 Gallon Anti-Freeze Drain

SKU 1485042  
BAL4110-025 **874<sup>99</sup>**

- Powder-Coated Green
- 3/4" Cam-Lock Fitting
- All-Steel Tank and Base
- Easy-to-Use Patented Cantilever Mechanism

Premium Drains Capture Used Fluids and Transfer Them to Any Bulk Storage Tank Using a Cam-Lock Kit and Evacuation System



Prices subject to change without notice. Prices do not include applicable taxes, vehicles, tires, rims, installation or optional equipment as shown. Please do not return purchases to the store. For information regarding warranty, repair, or any questions or concerns, call 901-300-4878.

AZG0226

# SPECIALTY TOOLS

## Line Repair Tools

### Double Flaring Tool Set

SKU **OSB 25358** **39<sup>99</sup>**

- Includes: 5 Adapters: 3/16", 1/4", 5/16", 3/8" and 1/2"
- Chrome Swivel Made of Alloy Steel to Reduce Friction
- Forged Yoke Made with Heat-Treated Steel



For OSB, Call 901-300-4878

OEM TOOLS®

### Single Flaring Tool

SKU **OSB 25359** **18<sup>99</sup>**

- Ideal for Making 45° Flares in Copper, Aluminum, Brass and Mild Steel Tubing
- Suitable for Tubing Sizes: 3/16", 1/4", 5/16", 3/8", 1/2" and 5/8"
- Makes a Precise Leak-Proof Flare That Fits Properly on Standard Fittings
- Flaring Bars are Heat-Treated for Durability



For OSB, Call 901-300-4878

OEM TOOLS®

### Bubble Flaring Tool Kit

SKU **592261 27214** **37<sup>99</sup>**

- Designed for Metric Soft Steel Brake Lines Where an "ISO" or Bubble Style Flare is Required
- Forged Yoke is Made of Heat-Treated Steel
- Includes: Flaring Bar, All Adapters Needed for ISO Bubble Flaring and 4 Dies (4.75, 6, 8 and 10 mm)



### Fuel Line Repair Assortment Kit

SKU **1392319** **DYNDY-FLA-2** **154<sup>99</sup>**

- Kit Includes: 23 of the Top Selling Connectors, Fittings and Clamps
- 86 Total Pieces



Dynamic

### Pro Series Repair Assortment

SKU **1125882** **AIR78019** **499<sup>99</sup>**

- Everything You Need for Transmission and Power Steering Line Repair in One Convenient Kit - 16 Repairs
- 5 Minute Line Repair
- Leak-Free to 2,600 psi
- OE Approved



AIRSEPT  
PART SMART

### Universal Flaring Set

SKU **954227** **MSC72475-PRC** **619<sup>99</sup>**

- Create Perfect Production Quality Flares
- Magnetic Adapter Holder Keeps Adapters in Place
- Tube and Die Set Stabilizing Arm for Easy Tube Forming
- Enlarged Die Set Compression Area for Better Grip of Dies

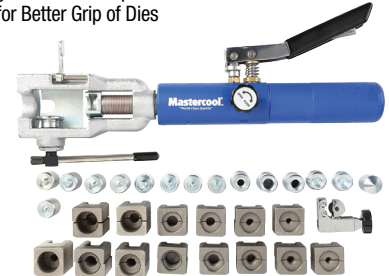

Mastercool®  
"World Class Quality"

## Disconnect Sets

### NAVISTAR® MAXXFORCE® Fuel Line Disconnect Tool Set - 4 Piece

SKU **004112** **25031** **34<sup>99</sup>** REG. \$49.99 **SAVE \$15**

- 4 Piece Disconnect Tool Set for NAVISTAR® MAXXFORCE® Series 11 and 13 Engines
- Sized to Depress Fuel Release Tabs for Efficient Fuel Line Removal
- 1 Straight and (1) 90° Tool for 11.8 mm Fuel Lines; 1 Straight and (1) 90° Tool for 16 mm Fuel Lines



Offer Good While Supplies Last Through June 30, 2026

OEM TOOLS®

### Fuel Line Disconnect Pliers

SKU **OSB 25241** **15<sup>99</sup>**

- Easily Remove or Attach Fuel Lines with Pinch-Style Tabs
- Offset Grip Design for Improved Leverage Around Fuel Lines in Tight Spaces
- Jaw Has Full Range of Motion for Grabbing Wires or Hoses



For OSB, Call 901-300-4878

OEM TOOLS®

NEW

### 6 Piece Disconnect Set

SKU **OSB 24681** **26<sup>99</sup>**

- Different Colors for Easy Identification
- Unique Offset Design Allows for Access in Confined or Obstructed Areas
- Sizes: 5/16", 3/8", 1/2", 5/8", 3/4" and 7/8"



For OSB, Call 901-300-4878

OEM TOOLS®

### Line Disconnect Set

SKU **1544674** **68941** **16<sup>99</sup>**

- Disconnects Fuel Lines and Spring Lock Couplings on Ford and Chrysler
- Sizes: 5/16", 3/8", 1/2", 5/8", 3/4" and 7/8"
- High Quality ABS Plastic that can Easily Stand Up to Daily Usage
- Works on Fuel Lines and Other Quick Disconnect Couplings on Domestic and Import Vehicles
- Angled Handles for Easy Access to Tight Spots
- Sizes Include: 1/4", 5/16", 3/8", 1/2", 5/8", 3/4" and 7/8"



OEM TOOLS®

### Angled Disconnect Set

SKU **291416** **LIS39400** **29<sup>99</sup>**

- Disconnects Spring Lock Couplings on Ford and Chrysler A/C Lines
- Works on Fuel Lines and Other Quick Disconnect Couplings on Domestic and Import Vehicles
- 6 Sizes: 5/16", 3/8", 1/2", 5/8", 3/4" and 7/8"

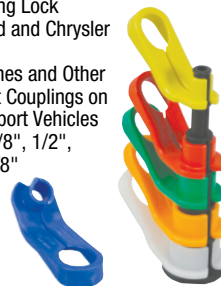

Lisle

### Master Disconnect Tool Set

SKU **291413** **LIS39900** **84<sup>99</sup>**

- Contains 8 Tools for A/C and Fuel Lines
- Comes in a Blow Mold Case



Lisle

## Spark Plug Service

### 3/8" Drive Magnetic Spark Plug 3 Piece Socket Set

SKU 300140 **14<sup>99</sup>**  
22891

- Includes: 5/8", 9/16" and 13/16"



#### Spark Plug Sockets

SKU	Part #	Drive	Size	Features	Price
082923	22880	3/8"	9/16"	Magnetic	<b>13.99</b>
082933	22887	3/8"	5/8"	Magnetic	<b>9.99</b>
082929	22881	3/8"	18 mm	Magnetic	<b>7.99</b>
082932	22883	3/8"	13/16"	Magnetic	<b>9.99</b>
082934	22889	1/2"	13/16"	Magnetic	<b>9.99</b>
082936	22895	3/8"	14 mm	12 Point Thin-Wall	<b>9.99</b>

### 14 mm x 12 Pt. BMW Spark Plug Socket

SKU 814164 **15<sup>99</sup>**  
22814

- Designed with a Universal Joint for the Installation and Removal of Spark Plugs Situated in Tight Spaces
- Durable Chrome Moly Steel Construction
- Overall Length: 3.75"
- Plug Retainer for a Secure Grip



12-POINT

### 3/8" Drive Magnetic Spark Plug Socket Extra Long (5/8")

SKU 300146 **14<sup>99</sup>**  
22885

- Hard Chrome™ Finish is Easy to Clean and Protects Against Rust
- Chamfered Ends Make Fastener Engagement Quick and Smooth
- Magnetic and Won't Wear Out or Be Damaged By Oil
- Deep Marking for Easy Identification Knurling Position for Best Finger Gripping
- Length: 6"



### 3/8" Drive Magnetic Spark Plug Socket Extra Long (9/16")

SKU 300147 **15<sup>99</sup>**  
22886

- Length: 6"



### 3/8" Drive 14 mm x 12 Pt. Extra Long Spark Plug Socket

SKU 814337 **21<sup>99</sup>**  
22813

- Designed with a Universal Joint for the Installation and Removal of Spark Plugs Situated in Tight Spaces
- Durable Chrome Moly Steel Construction
- 12" Extended Reach



Swivel Joint

### Adjustable Spark Plug Boot Pliers

SKU 1340226 **23<sup>99</sup>**  
25559

- Jaws Adjust to Five Different Positions for Easy Access to Spark Plug Boots
- Rubber Dipped Jaws Provide a Secure Grip for Damage Free Removal of the Spark Plug Boot
- Hardened Jaws Will Not Bend When Gripping
- Dipped Handle Grips for a Comfortable and Sure Grip

OEM TOOLS



### Spark Plug Boot Pliers

SKU 390900 **13<sup>85</sup>**  
25542

- Designed to Remove Hard-to-Reach Spark Plug Boots
- 45° Offset Jaws for Easy Gripping of Wires and Boots



STORE STOCKED

### Spark Plug Wire Puller

SKU 532549 **4<sup>99</sup>**  
25061

- Insulates Hands from Electric Shock
- Grips Directly on Boot to Prevent Wire Damage



STORE STOCKED

## Specialty Sockets

### IPR Socket, 3/8" Drive

SKU 912334 **14<sup>99</sup>**  
25280

- Remove/Replace IPR without Damaging the Connector
- Applications: Ford 6.0 L and Other Diesel Engines



### Oxygen Sensor Socket Set

SKU 1103591 **27<sup>99</sup>**  
37110

- Special Purpose, Universal Slotted Socket That Services Hex Vacuum Switches and Oxygen Sensors
- Includes Sockets for Most Applications: 3/8" Drive 7/8" (22 mm) Deep 3/8" Drive 7/8" (22 mm) Crowfoot 1/2" Drive 7/8" (22 mm) Deep Crowfoot



### 7 Piece Sensor Socket Set

SKU 900823 **48<sup>99</sup>**  
27189

- Used for Oil Pressure Switches, Oil Pressure Sending Units and Thermal Sensor Switches
- Includes: 7/8" (22 mm) Offset Extended Oxygen Sensor, 7/8" (22 mm) Offset Oxygen Sensor Socket, 7/8" (22 mm) Vacuum Switch Socket, 7/8" (22 mm) Oxygen Sensor Socket, 1-1/16" (27 mm) Deep Oil Switch Socket, 1-3/16" (29 mm) Oil Sender Unit Socket and 1-1/16" (27 mm) GM Thermal Sensor Switch Socket
- Chrome Vanadium for Toughness



## Remote Starter

### Heavy Duty Remote Starter Switch

SKU 265127 **24<sup>99</sup>**  
25331

- 63" (160 cm) Heavy Insulated Wire for Long Tool Life
- Heavy Duty Insulated Alligator Clips
- Rugged Rubber Housing
- Switch Amps: 30A @ 6V and 12V; 15A @ 24V
- Weight: 9.5 Oz.



## Insulated Tools

### 10 Piece Insulated Screwdriver Set

SKU 1267942 **37<sup>99</sup>**  
22593

- 1,000V VDE Certified Insulated Screwdrivers
- Insulated Grip Handle and Precision Handle for Added Efficiency
- Insulation Sculpted Directly Onto Blade for Permanent Bonding
- Quick-Release Mechanism for Effortless Blade Change
- Exchangeable Blades with a Slim Tip to Fit Tight Terminal Blocks
- Durable Tool Pouch Included for Easy Organization
- Includes: 4 Slotted Blades



OEM TOOLS

### Remote Starter Switch

SKU 265124 **20<sup>99</sup>**  
25330

- Heavy Clips with Insulated Sleeves Attach to Ground and Starter Solenoid Switch Thumb Activated Switch 83" Heavy Insulated Wire for Long Tool Life



# SPECIALTY TOOLS

## Fuel Pump Tools

### Fuel Tank Adapter

SKU 1407554 **219<sup>99</sup>**  
24832

- Makes Fuel Tank Removal Safe and Easy
- Works with Most Transmission Jacks
- Includes: 2 Nylon Straps to Secure Tank
- Foam Rubber Pads Protect Tank



OEM TOOLS®

### Bed Lifter

SKU OSB **369<sup>99</sup>**  
STK35885

- Designed to Lift Truck Beds Safely and Easily
- Lifting Brackets Adjusts to Evenly Distribute Weight



For OSB, Call 901-300-4878

STECK  
Innovative auto/body tools and equipment

OEM TOOLS®

### Fuel Tank Lock Ring Tool

SKU 751721 **39<sup>99</sup>**  
24398

- Ford F150 Trucks (2004 - Newer); Chrysler/Dodge Mini-Vans, PT Cruiser, Dakota, Durango (2004 - Newer); Chevy 1/2 Ton and 3/4 Ton Trucks (2004 - Newer)
- Works with 1/2" Drive Ratchet or Breaker Bar



### Fuel Pump Module Spanner Wrench

SKU 110278 **29<sup>99</sup>**  
25156

- Removes and Installs the Fuel Pump Retaining Ring



OEM TOOLS®

### Adjustable Multi-Arm Lock Ring Tool

SKU 1491306 **34<sup>99</sup>**  
25558

- Interchangeable Arms to Remove and Install the Retaining Ring on the Fuel Pump Module
- Adjustable Arms to Easily Adjust to the Fitment of the Retaining and Locking Rings
- Slip Resistant Spanner to Limit Damage to the Lock Ring and Retaining Ring
- 3/8" Square Drive



OEM TOOLS®

## Throttle Depressors

### Brake - Accelerator Pedal Depressor

SKU 802194 **42<sup>99</sup>**  
24232

- Holds Brake or Accelerator Pedal at Desired Position
- Easy to Adjust
- Extends to 24"
- Suitable for Many Diagnostic Applications



OEM TOOLS®

### Steering Wheel Holder and Pedal Depressor Set

SKU 802195 **124<sup>99</sup>**  
24231

- Holds Steering Wheel in Position for Alignment Adjustments
- Depresses Brake Pedal for Various Brake Checks Including Brake Lamp Operation
- Simply Hand Squeeze the Actuator to Accomplish Fine Adjustments

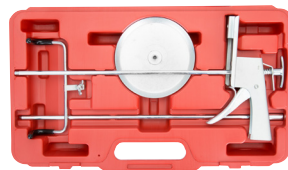

OEM TOOLS®

### Throttle Pedal Depressor

SKU 222525 **54<sup>99</sup>**  
LIS48700

- Holds Throttle at a Constant RPM
- Engage the Nylon Hook Under the Steering Wheel, Then Extend the Depressor Rod to the Accelerator Pedal
- Length: 40"

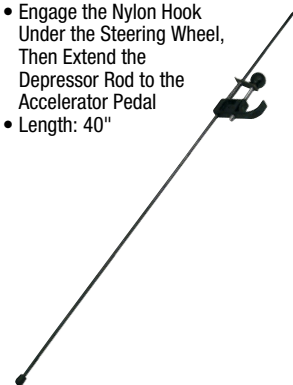

Lisle

## Terminal Tools

### 19 Piece Master Terminal Tool Set

SKU 447159 **99<sup>99</sup>**  
27169

- Latest Tools for Coolant Sensors, Wiring Harnesses and Terminal Blocks on Most Modern Vehicles
- Eliminates Potential Damage to Wires or Terminal Blocks
- Application Chart Included Inside Storage Case



OEM TOOLS®

## Wire Strippers

### 9-1/2" Terminal Crimping Pliers with Cutter

SKU OSB **13<sup>99</sup>**  
25196

- For Insulated and Non-Insulated Wire Connectors and Terminals
- Specially Hardened Wire Cutter in Nose
- Tapered Nose for Working in Confined Spaces
- For 10 to 22 AWG Wire Connect
- Plastic-Dipped Comfort Handles Minimize Fatigue



For OSB,  
Call 901-300-4878

### 8-1/4" Wire Stripper/Cutter/Crimper/Bolt Cutter

SKU 312821 **20<sup>99</sup>**  
25193

- AWG: 10, 12, 14, 16, 20 and 22 Stranded
- AWG: 8, 10, 12, 14, 16 and 18 Solid
- Crimps 7 and 8 mm Ignition Terminals

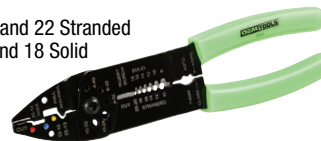

OEM TOOLS®

### 6" Wire Stripper

SKU OSB **39<sup>99</sup>**  
25191

- Precision Ground Saws
- 10 to 22 AWG Spring Loaded with Built-in Lock Cushioned Grip Handles



For OSB, Call 901-300-4878

### 7" Wire Stripper Crimper - Cutter

SKU 751657 **20<sup>99</sup>**  
24452

- Strips 20-12 Gauge Insulated and Non-Insulated Wire
- Use for Wire Cutting and Stripping, as Pliers for Grabbing and Twisting or for Crimping of Insulated and Non-Insulated Connectors
- Industrial Finish with Red Textured Grips



### 6-in-1 Long Nose Pliers

SKU OSB **20<sup>99</sup>**  
22631

- Wire Strippers: 10, 12, 14, 16, 18, 20, 22 AWG
- Wire Crimper: 10 - 20 AWG
- Ergonomic Pistol Grip for Added Leverage
- Ideal for Hard-to-Reach Spot



For OSB, Call 901-300-4878

Prices subject to change without notice. Prices do not include applicable taxes, vehicles, tires, rims, installation or optional equipment as shown. Please do not return purchases to the store. For information regarding warranty, repair, or any questions or concerns, call 901-300-4878.

# SPECIALTY TOOLS

TO ORDER, contact your Commercial Sales Manager or go to [AutoZonePro.com](http://AutoZonePro.com)

SPECIALTY TOOLS

## PowerProbe

### ECT3000 Electrical Circuit Tracer

SKU 1392338 **194<sup>99</sup>**  
PWPECT3000B

- Automatic and Manual Sensitivity Locking
- Arrow Indicates Direction to Short
- Signal Distance Indicator Bar
- 10 Minute Auto Shut Off
- Ergonomic Housing



### Memory Saver/Parasitic Drain Monitor

SKU 1580963 **234<sup>99</sup>**  
PWPPDRAW

- Connects Via 16Pin OBDII Port and Supplies Power and Monitors the Vehicles Electrical System for Parasitic Draw
- View and Record Data Via Bluetooth on Power Probe Link App
- Graphing Mode for Displaying Voltage and Amperage as a Wave Form
- Readings are Displayed on the LCD Screen
- Capable of Delivery Up to 10 Amps Continuous Current

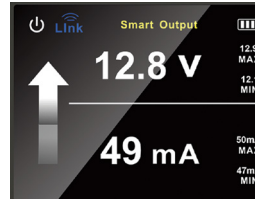

## Circuit Testers

### Coiled Cord Circuit Tester

SKU 422468 **12<sup>99</sup>**  
25886

- Circuit Tester with a Stretchable and Retractable 12' Cord for Long Circuit Runs



### One Handed Wire Piercing Circuit Tester

SKU OSB 16<sup>99</sup>  
25887

- Bright Hi-Vis 12' Heat and Oil Resistant Coiled Cord
- Molded Strain Relief for Long Life
- Hangs on Wire for Hands-Free Operation
- 6, 12 and 24 Volt Systems



For OSB, Call 901-300-4878

## Relay Pliers



### Relay Puller Pliers

SKU 291342 **34<sup>99</sup>**  
LIS46950

- For Removing Electrical Relays on Most Domestic and Import Vehicles
- Allows Relay to Pop Free from Socket with Less Chance of Damaging the Relay



### Heavy Duty Circuit Tester

SKU 006511 **34<sup>99</sup>**  
25019

- For Testing 6 and 12 Volt Systems for Wire Breaks, Shorts, Fuses, Lamps, Relays, Armatures and More



### Digital Display Circuit Tester

SKU 568468 **44<sup>99</sup>**  
24451

- Detect Voltage, Power, Ground and Circuit Condition
- Display Provides Precise Voltage
- Voltage: 5 to 30V DC
- Computer Safe - DO NOT Use on Airbags



Voltage Display



### 60° Electrical Disconnect Pliers

SKU OSB 29<sup>99</sup>  
LIS37980

- Removes Push-Tab Electrical Connectors
- Hook and Point Allow Damage-Free Separation
- Spring Action for One-Handed Use
- Comfortable Dual Durometer Grips

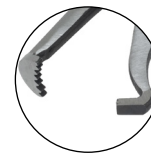

For OSB, Call 901-300-4878

## Windshield Tools

### Compact Windshield Wiper Arm Puller

SKU 191681 **13<sup>99</sup>**  
25319

- Easily Removes Wiper Arms on Most Domestic and Foreign Vehicles
- Will Not Damage Wiper Arm or Hood Cowling During Removal
- Features Turning Knob for Fast Work and Forged Body for Strength
- Compact Design Works Great in Tight Spaces



### Universal Wiper Arm Puller

SKU 265136 **34<sup>99</sup>**  
25339

- For Pulling Front and Rear Wiper Tight Fitting Wiper Arms
- Suitable for Most Wiper Arms Including Audi®, VW®, BMW®, Ford®, Chevrolet®, Mercedes-Benz® and Others
- Designed to Prevent Damage to Wiper Arm Nozzle



### Window Holder Tool

SKU 191670 **10<sup>99</sup>**  
25309

- Works on All Cars and Trucks with a Top Door Frame
- Loop Cable Over Door Frame and Attach Suction Cups to Each Side of Glass
- Window Glass is Securely Held Above the Door While Work is Performed



### Double Head Suction Cups

SKU 291351 **18<sup>99</sup>**  
24246

- Twin Head Suction Cups Help Remove Windshields
- ABS Rubber Cups Grab Hold of Glass
- Flexible Handle Bends to Windshield
- Quick Release Levers for One-Hand Operation



Prices subject to change without notice. Prices do not include applicable taxes, vehicles, tires, rims, installation or optional equipment as shown. Please do not return purchases to the store. For information regarding warranty, repair, or any questions or concerns, call 901-300-4878.

AZG0226

55

# SPECIALTY TOOLS

## Torque Wrenches

### 3/8" Drive (10-80 Ft/Lb.)

SKU 177722 **64<sup>99</sup>**  
25694

### 1/2" Drive (10-150 Ft/Lb.)

SKU 012651 **79<sup>99</sup>**  
25689



### 1/2" Drive (25-250 Ft/Lb.)

SKU 177715 **79<sup>99</sup>**  
25695

### 3/4" Drive Torque Wrench (50-400 Ft/Lb.)

SKU 1103610 **399<sup>99</sup>**  
37309

#### Ideal for Replacing Ford F150 Front Wheel Bearings

- Range: 50-400 Ft/Lb. and 84.7-559.2 N-m
- Increments 2.5 Ft/Lb.



### 1/4" Drive Deflection Beam Torque Wrench

SKU OSB **21<sup>99</sup>**  
25439

- Can Be Used on a Number of Fastening Applications Including Boats, Cars, Motorcycles and Bikes
- 80 In/Lb. (0-9 Nm) in Maximum Working Torque Dual Range Scale Features In/Lb. and Newton Meter Measurement
- Delivers Accurate Measurements When Used Clockwise or Counterclockwise
- Hard-Spring Steel Beam Resists Bending to Deliver Precise Readings



For OSB,  
Call 901-300-4878

### 3/4" Drive Torque Multiplier

SKU 191056 **369<sup>99</sup>**  
25683

- Increased Torque Output Converts Low Torque (Max. 650 Ft/Lb.) to High Torque (2,200 Ft/Lb., 3000 Nm) with Planetary Gear Set for Heavy Duty Tightening and Loosening
- Input Drive: 3/4"
- Output Drive: 1"



### 3/8" Drive Torque Wrench (25-250 In/Lb.)

SKU 133657 **52<sup>99</sup>**  
25685

- 45 Tooth Round Head Ratchet
- Both Clockwise and Counterclockwise Operation



### 3/8" Drive Click Style Torque Wrench

SKU 133658 **52<sup>99</sup>**  
25686

- Precision Torque Control by 45-Tooth Ratchet Head
- Audible Click When Desired Torque is Reached
- Both Clockwise and Counterclockwise Operation
- High Grade Spring Steel Torque Mechanism



### 1/2" Drive Click Style Torque Wrench (25-250 Ft/Lb.)

SKU 133659 **89<sup>99</sup>**  
25687

- Both Clockwise and Counterclockwise Operation

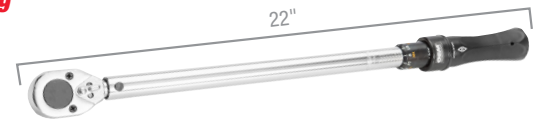

### 3/4" Drive Professional Micrometer Torque Wrench (100-600 Ft/Lb.)

SKU 217376 **369<sup>99</sup>**  
25688

- Right Hand Direction

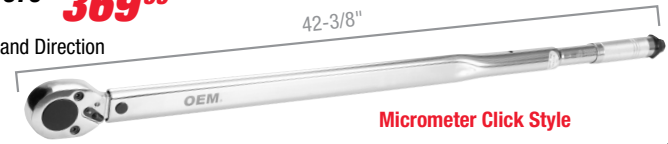

Micrometer Click Style

## Measuring Tools

### Tire Tread Depth Gauge

SKU 954233 **49<sup>99</sup>**  
CEN3S402A

- Easy-to-Read Digital Display
- Fractional Scale in 1/32" Increments
- Spring-Loaded Plunger



Central TOOLS, Inc.  
QUALITY AND INNOVATION SINCE 1958

### 24" Straight Edge

SKU 949552 **49<sup>99</sup>**  
25355

- Constructed with 1/4" Thick Cold Rolled Steel
- Durable Powder Coat Finish with Precision Ground Edge
- Hang Hole for Convenient Storage
- Includes Reusable Protective Edge

OEM TOOLS<sup>®</sup>



MADE IN U.S.A.

### 1" Dial Indicator Set

SKU 954195 **99<sup>99</sup>**  
CEN3D101

- Strong Magnetic Base
- Revolution Counter
- Full 1" Range



Central TOOLS, Inc.  
QUALITY AND INNOVATION SINCE 1958

### Indicator Set with Flex Arms and Lock Pliers

SKU 954184 **149<sup>99</sup>**  
CEN3D103

- Locking Pliers for Mounting
- Flex Arm for Extra Reach
- Revolution Counter
- Full 1" Range



Central TOOLS, Inc.  
QUALITY AND INNOVATION SINCE 1958

### Extended Range Bore Gauge

SKU 954188 **244<sup>99</sup>**  
CEN3D302

- Extended Range of 1.4" to 6"
- Lower Range for Small Applications
- Reach Deep into Cylinders



Central TOOLS, Inc.  
QUALITY AND INNOVATION SINCE 1958

### 0-5.5" Digital Rotor Gauge

SKU 954197 **109<sup>99</sup>**  
CEN3M430A

- Easy-to-Read Digital Display
- Pointed Anvil for Measuring Grooves
- Inch and Metric Readings



Central TOOLS, Inc.  
QUALITY AND INNOVATION SINCE 1958

### Digital Drum Gauge

SKU 954196 **289<sup>99</sup>**  
CEN3B531

- Depth Stops to Improve Accuracy
- Pointed Anvils for Grooves
- Easy-to-Read Digital Display
- 4" to 20" Range Plus Oversize



Central TOOLS, Inc.  
QUALITY AND INNOVATION SINCE 1958

### 6" Electronic Digital Caliper

SKU 864649 **24<sup>99</sup>**  
25363

- Large Easy to Read LCD Display
- Zeroing Feature
- Thumb Roller with Locking Device



OEM TOOLS<sup>®</sup>

# SPECIALTY TOOLS

TO ORDER, contact your Commercial Sales Manager or go to [AutoZonePro.com](http://AutoZonePro.com)

SPECIALTY TOOLS

## Steck - Lockout Tools

### BigEasy™ Glo with Easy Wedge Lockout Kit

SKU 964494 **89<sup>99</sup>**  
STK32955

- Glow-In-The-Dark Yellow Allows You to See the Tool at Night or Through Tinted Windows
- Easy Wedge Offers Controlled Opening of the Car Door for Inserting the BigEasy Glo



Glows in the Dark

### BigEasy™ Carrying Case

SKU 227873 **39<sup>99</sup>**  
STK32935

- Made of Soft, Yet Firm Material to Protect Your BigEasy Kit
- Custom Pockets for the BigEasy, Non-Marring Wedge, Lock Knob Lifter and Easy Wedge
- Makes it Convenient to Stow Your BigEasy Kit in Your Truck



### BigEasy™ Lockout Kit

SKU 964491 **44<sup>99</sup>**  
STK32900

- High Visibility Pink Powder Coating and Improved Non-Marring Wedge
- Lock Knob Lifter for Cars with Flat Lock Knobs at the Top of the Door
- Paint Protector Reduces Friction Between the Car Door and the BigEasy

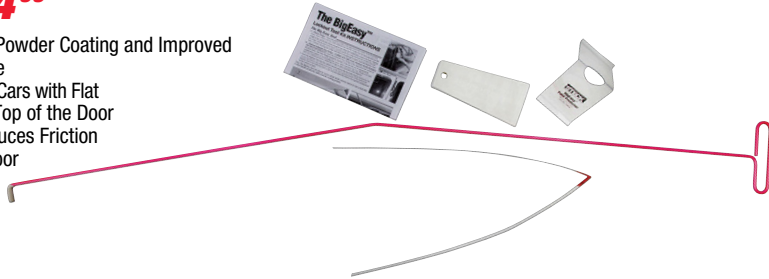

### BigEasy™ Easy Wedge (Inflatable)

SKU 964493 **39<sup>99</sup>**  
STK32922

- Inflatable Controlled Opening of Car Door for Insertion of the BigEasy™



## Access Tools - Lockout Tools

### Emergency Response Kit Long Case

SKU 1339730 **169<sup>99</sup>**  
AETERKLC

- Most Popular Accessories, Gets into Any Vehicle
- Designed by First Responders
- Emergency Ready
- Includes: Quick Max Long Reach Tool, Flex Max, Button Master, Super One Hand Jack Tool, Super Air Wedge, Glassman Wedge and Button Strip Tool

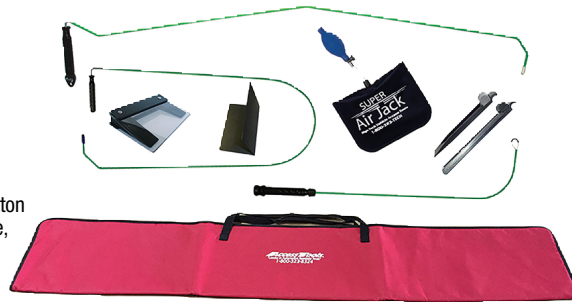

### Button Master

SKU 1189051 **54<sup>99</sup>**  
AETRCBM

- Flexible Coated Long Reach Tool
- Retractable Loop with Grip Cover
- Grab Vertical Door Buttons with Ease
- Approximately 38" in Length When Straightened
- Most Flexible and Versatile Version of All the Button Masters



### One Hand Jack Set

SKU 1145698 **144<sup>99</sup>**  
AETOHJS4

- Easy-to-Use Car Opening Kit
- Soft Shielded Long Reach Tool That Won't Scratch Paint
- Air Wedge with Stiff Insert for Easy Insertion
- Vertical Button Tool One Hand Jack for Quick, Damage-Free Insertion of the Air Jack



## Rivet Tools

### Rivet Tool Kit

SKU 94877 **121<sup>99</sup>**  
MAR39001KIT

- 50 each: SB4-2, SB4-4, AB4-2A
- 25 each: SC4-4, AB6-2



### Big Daddy® Hand Riveter

SKU 094886 **294<sup>99</sup>**  
MAR39031

Sets Large Diameter Blind Rivets.

- Double Gear Reduction System Easily Sets from 1/8" to 1/4" Diameter Klik-Fast Rivets in All Alloys Including 1/4" Klik-Split® Rivets
- Comes with 5/32", 3/16" and 1/4" Nose Pieces Stored in the Body



### Industrial Hand Riveter

SKU 291353 **64<sup>99</sup>**  
25921

- For Use with Steel and Aluminum Rivet Noses: 1/8" (3.2 mm), 5/32" (4.0 mm), 3/16" (4.8 mm), 1/4" (6.4 mm)
- Overall Length: 18"
- Maximum Spread: 7"
- Maximum Reach: 5-1/2"
- Long Handle Provides More Leverage



Includes Aluminum Rivet Noses



See More Marson Rivet Tools on [AutoZonePro.com](http://AutoZonePro.com)

Prices subject to change without notice. Prices do not include applicable taxes, vehicles, tires, rims, installation or optional equipment as shown. Please do not return purchases to the store. For information regarding warranty, repair, or any questions or concerns, call 901-300-4878.

AZG0226

57

# SPECIALTY TOOLS

## Slide Hammer Pullers

### 5 Lb. Slide Hammer

SKU 1103572 **59<sup>99</sup>**  
37033

- For Use with OEMTOOLS® 27032 Axle Puller, 27058 Inner CV Joint Puller, 27059 Pilot Bearing Puller, and Other Puller Attachments with 5/8" X 18 Threads
- For a Variety of Pulling Tasks
- Chrome Plated Main Shaft
- Thread: 5/8" x 18



### 9 Way Slide Hammer Puller Set

SKU 1335798 **99<sup>99</sup>**  
37191

- Pulls Flange-Type Rear Axles and Most Front Wheel Drive Hubs
- Internal and External Jaws Provide a Variety of Combinations to Pull Bearings, Gears and Seals
- 2-Way and 3-Way Cross Blocks
- Includes: Grip Wrench Adapter and Dent Puller Attachment
- Designed for Use with Other 5/8" x 18 Thread Slide Hammer Attachments

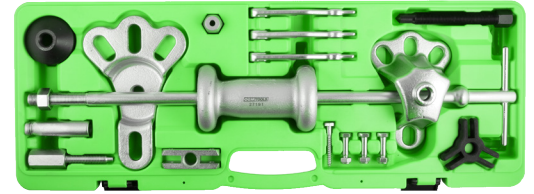

OEM TOOLS®

### Rear Axle Puller Set

SKU 094801 **89<sup>99</sup>**  
27202

- Use for Flange-Type Rear Axle and Bearing Removal on Most Late Model Passenger Cars and Light Trucks
- Slide Rod and Adapters are 5/8" x 18 Standard Threads

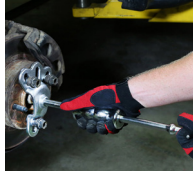

### VW/Audi Fuel Injector Puller Kit

SKU 1103636 **64<sup>99</sup>**  
37383

- Includes: 1 Mini Slide Hammer, 1 Installation Tool, 2 Special Puller Attachments and 3 Knurled Collars
- Comes in a Sturdy Blow Mold Case
- Used with All 2.0 L TSI/FSI/TSFI Engines



## Multi-Purpose Puller

### Multi-Purpose Bearing and Pulley Puller Set

SKU 900824 **149<sup>99</sup>**  
27190

- Use on Pitman Arms, Timing Gears, Carrier Side Bearings, Crankshaft Pulleys and More
- 20 Piece Set Includes: 6 Jaws, 2 Bar Housings, 6 Bolts and 2 Retainers
- Capacity: 6-10 Tons (Depending on the Jaws)
- Combine to Create 10 Different Pullers



OEM TOOLS®

## Retainer Remover

### Brake Cylinder Retainer Remover

SKU 265111 **17<sup>99</sup>**  
25268

- Expands and Holds Special Retainer So the Brake Cylinder May Be Removed
- Releases the Spring Clip Retainer That Attaches the Rear Brake Cylinder to Backing Plate



OEM TOOLS®

## Lock and Snap Ring Pliers

### Professional Internal/External Snap Ring Pliers

SKU 1340233 **22<sup>99</sup>**  
25097

- Unique Jaw Design Makes it Easy to Switch from Internal to External Configurations
- For Both Internal and External Rings
- Alloy Steel and PVC Grip with Storage for Tips
- Includes: 3 Pairs of Tips and Hex Key, 1 Pair Straight Tips for 1.2 mm and 1.8 mm, 2 Pair 90° Tips for 1.2 mm and 1.8 mm



### Angle Tip Lock Ring Pliers

SKU 191055 **19<sup>99</sup>**  
25354

- For Spreading Snap Rings Found on Brakes, Pedal Shafts, Clutch Shafts, Transmissions, Machine Tools and Piston Rings
- Constructed with Durable Drop Forged Steel Alloy
- Spring-Loaded Jaws Feature a Scored Outside Edge for a Secure Grip
- Vinyl Grip Handles for Added Comfort and Control
- Spread: 3/4"
- Length: 8-1/4"



### 10 Piece Snap Ring Pliers Set

SKU 900819 **89<sup>99</sup>**  
27180

- Includes:
  - (2) 5-1/2" Bent Pliers (0.038" and 0.047" Tip),
  - (2) 6" Straight Pliers (0.038" and 0.047" Tip),
  - 7-1/2" Bent Pliers (0.070" Tip),
  - 8" Straight Pliers (0.070" Tip),
  - 8-1/2" Bent Pliers (0.090" Tip),
  - 9" Straight Pliers (0.090" Tip),
  - 1 Pick Tool and 1 Hook Tool
- For Both Internal and External Rings
- Constructed with Heat-Treated Chrome Moly Steel
- Comes in Sturdy Blow Mold Case

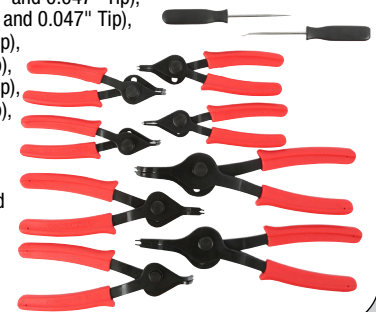

OEM TOOLS®

## Jaw Pullers

- Adjustable and Reversible Jaws with 2 and 3 Jaw Configurations Available
- Remove Gears, Pulleys and Other Components in Various Applications, from Automotive to Heavy Duty Vehicles and Equipment
- Heavy Duty Forged Construction with Chrome and Black Oxide Finishes Protect Against Corrosion

SKU	Part #	Capacity	Jaw	Spread	Reach	Price
246386	25902	1 Ton	2/3 Jaw	3"	3-1/4"	<b>29.99</b>
246387	25903	5 Ton	2/3 Jaw	4"	4-3/4"	<b>34.99</b>
OSB	25901	2 Ton	2/3 Jaw	6"	4-3/4"	<b>38.99</b>
OSB	25920	5 Ton	3 Jaw	6-1/4"	5-1/2"	<b>10.99</b>
141513	25914	5 Ton	2 Jaw	6"	3-1/4"	<b>30.99</b>
OSB	25919	5 Ton	2/3 Jaw	7"	5-1/2"	<b>43.99</b>

For OSB, Call 901-300-4878



25903



OEM TOOLS®

## Cam/Crankshaft Tools

### Crank Bolt Sockets

Deep Counter-Weighted Sockets Provide Increased Torque to Break Loose Stubborn Crank Bolts

- Applications: Honda-Acura, Models: Accord, Civic, Pilot, CRV, Odyssey, CL TL Integra, MDX, Vehicles. Plus Toyota-Lexus, Models: Camry, Corolla, 4Runner, Sequoia, ES300, LS400 Vehicles and More

**17 mm**  
SKU 912348 **19<sup>99</sup>**  
25275

**19 mm**  
SKU 1335801 **16<sup>99</sup>**  
25290

**21 mm**  
SKU 912343 **19<sup>99</sup>**  
25273

**22 mm**  
SKU 70132 **19<sup>99</sup>**  
25300

**26 mm**  
SKU 919500 **17<sup>99</sup>**  
25278

**27 mm**  
SKU 919497 **19<sup>99</sup>**  
25279



OEM TOOLS®



### 6 Piece Crank Bolt Socket Set

SKU 919501 **99<sup>99</sup>**  
25276

- Includes: 17, 19, 21, 22, 26 and 27 mm Deep Counter-Weighted Sockets
- Provides Increased Torque to Break Loose Stubborn Crank Bolts
- Applications: Honda-Acura, Models: Accord, Civic, Pilot, CRV, Odyssey, CL TL Integra, MDX, Vehicles. Plus Toyota-Lexus, Models: Camry, Corolla, 4Runner, Sequoia, ES300, LS400 Vehicles and More
- Constructed with Durable Chrome Moly Steel

### Universal Pulley and Fan Clutch Holder

SKU 547013 **59<sup>99</sup>**  
27281

- Fits Many Different Fan Clutches, Cam and Crank Pulleys with Slots or Holes Adjustable Diameter: 1-1/2" to 8-5/8" Pin Sizes: 6-10 mm, 8-11 mm, 10-12 mm and 11-16 mm
- Comes in Blow Mold Case



OEM TOOLS®

### 5 Piece Master Cam/Timing Gear Clamp Set

SKU 383452 **32<sup>99</sup>**  
27210

- Covers Most Single, Twin Cam and Quad Cam Engines
- Locks Camshaft to Hold Valve Timing During Timing Belt Replacement



OEM TOOLS®

### Ford Cam Tool 1.6 Liter

SKU 1103640 **22<sup>99</sup>**  
37380

- Designed to Hold the VCT Sprockets in Position During Timing Belt Installation or Camshaft Service
- Alignment Tool Services: Ford Fiesta (2011 to 2014), Ford Escape (2013 to 2014), Ford Fusion (2013 to 2014), Ford Transit (2013 to 2014)



OEM TOOLS®

### Ford 2.0 L, 2.3 L, 2.5 L Cam Tool Kit

SKU 626108 **14<sup>99</sup>**  
24448

- Applications: 2.0 L DOHC Engines Found in Ford and Mercury (1994 to 2003), 2.5 L DOHC, 2.3 L DOHC 4V and 2.0 L DOHC Engines in Ford, Mercury and Mazda (2004 to 2012) and 2.0 L DOHC Engines in Ford Probe (1993 to 1994)



OEM TOOLS®

### Ford Timing Chain Locking Wedge Tool

SKU 012647 **11<sup>99</sup>**  
24207

- For 2005-14 5.4 L and 4.6 L 3V OE Type Tool Allows for Easy Cam Changes without Removing the Timing Cover
- Compact and Easy to Use
- OE Type Tool
- For 5.4 L and 4.6 L 3V (2005-2014)



OEM TOOLS®

### DOHC Cam Lock Holder

SKU 291419 **59<sup>99</sup>**  
LIS36880

- This Versatile Tool Easily Locks and Holds Both Camshaft Sprockets Firmly in Place
- Preserves the Engine Timing During Belt or Chain Replacement



### Pilot Bearing Puller

SKU 775523 **30<sup>99</sup>**  
25089

- Use to Pull Pilot Bearing from End of Crankshaft
- Plate Prevents the Jaws from Spinning When Force is Applied
- Spread Range: 1/2" to 1-1/2"
- Reach Range: 3/16" to 11/4"



OEM TOOLS®

### Pilot Bearing Puller Attachment

SKU 1368778 **19<sup>99</sup>**  
27059

- Use with OEMTOOLS 37033 and 27202 Slide Hammer Pullers
- Threaded with Both 5/8" x 18 and 3/4" x 16 Threads to Fit Most Slide Hammers



OEM TOOLS®

### Ford Master Timing Kit

SKU OSB **284<sup>99</sup>**  
CTA2221

- Includes: Harmonic Balancer Holder, Camshaft Alignment Tool, VCT Alignment Tool, Crankshaft Positioning Tool, Crankshaft Vibration Dampener Alignment Tool, 3 Pc. Wedges and Camshaft Timing Kit
- Services Ford, Mazda and Lincoln 1.4 L, 1.5 L, 1.6 L, 2.0 L, 2.3 L, 2.5 L, 3.0 L and 3.5 L Engines

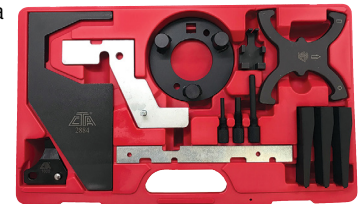

For OSB, Call 901-300-4878



### Flywheel Turner

SKU 1207891 **19<sup>99</sup>**  
25556

- Holds Flex Plates and Fly Wheels to Allow Clutch, Transmission and Crankshaft Service
- Spring Tensioned to Keep the Wrench Securely Engaged
- Sure Grip Handle



OEM TOOLS®

### Universal Camshaft Bearing Tool

SKU 191677 **209<sup>99</sup>**  
27143

- Removes or Inserts Camshaft Bearings in Nearly All Engines
- Set Includes: Driving Shaft, Driving Shaft Extension, Expander Unit, 5 Split Driving Plugs, 2 Driving Collars and Centering Cone
- Easy on Bearings
- Range: 1.125" to 2.69"



OEM TOOLS®

# ENGINE SERVICE

## Valve & Cylinder Head Tools

### Combustion Leak Detector

**OEM TOOLS**

SKU 1103608  
37145 **25<sup>99</sup>**

- Test for Internal Combustion Leaks on Gasoline Engines
- Fluid Color Changes to Yellow When a Combustion Leak is Present
- Comes in a Sturdy Blow Mold Case
- Not for Use with Diesel Engines



### Combustion Leak Detector Fluid (8 Oz.)

SKU 391381  
25739 **9<sup>90</sup>**



**STORE STOCKED**

### Flexible Air Valve Holder

**OEM TOOLS**

SKU 1392465  
25029 **6<sup>99</sup>**

- For 14 mm and 18 mm Spark Plug Holes
- 14" Flexible Hose Reaches into Tight Areas



### Valve Keeper Remover and Installer Kit

**Lisle**

SKU 011658  
LIS36050 **119<sup>99</sup>**

**Makes Valve Component Disassembly and Reassembly Fast and Easy**

- For Use with Valve Stems from 4.5 to 7.5 mm and 5/16" to 3/8"
- Magnet in Tool Body Captures Keepers
- Smaller Size Works on Toyota 4 Cylinder and Chrysler New World Engine



### Hydraulic Valve Lifter Puller

**OEM TOOLS**

SKU 424904  
27146 **24<sup>99</sup>**

- Use for Removing Many Valve Lifters from Engine Block



### Ford Valve Spring Compressor

**OEM TOOLS**

SKU 626111  
24434 **24<sup>99</sup>**

- Applications: 1991 to 2004 Ford Vehicles with 4.6 L, 2V, V8 Engines; 4.6 4V, 5.4 V8 and 6.8 V10
- Works with Engine Removed or Installed, Cylinder Head On or Off
- Not for Triton 5.4 3V



### Lever Valve Spring Compressor

**OEM TOOLS**

SKU 662780  
24676 **59<sup>99</sup>**

- Lever Action Stays Compressed for Easy Valve Lock Removal
- Included Adapters Fit Valve Retainer Diameters from 1" (25 mm) to 1-3/16" (30 mm)
- Compression Range from 1-3/8" to 5-5/8" (35 mm to 142 mm)



### Valve Spring Compressor

**OEM TOOLS**

SKU 552331  
25064 **11<sup>99</sup>**

- Compresses Valve Springs on GM V8 Engines with Stud-Type Rocker Arms without Having to Remove Cylinder Heads
- Use with OEMTOOLS® 25029



### Ford Valve Spring Compressor for 3-Valve Engines

**OEM TOOLS**

SKU 814391  
24429 **24<sup>99</sup>**

- Designed to Compress the Valve Spring without Removing the Camshaft While Servicing the Cylinder Head in Ford 3-Valve Engines
- For Use with Ford 3-Valve 4.6 L and 5.4 L Engines



### Push Rod Remover

**OEM TOOLS**

SKU 459100  
LIS48300 **29<sup>99</sup>**

- Redesigned for Newer 3.5 L and 3.6 L GM Engines - Also Works on GM V6 2.8L, 3.1 L and 3.4L
- Quickly Removes Push Rods to Replace the Intake Gaskets without Removing Rocker Arms



### Torque Adapter, Diesel Head Bolt, Ford 6.0 L Power Stroke® Engines

**OEM TOOLS**

SKU 298191  
24208 **16<sup>99</sup>**

- Eliminates the Need to Remove the Truck/Van Cab from the Chassis to Access the Rear Head Bolts
- Eliminates the Need to Remove the Evaporator Housing, Saving 2 Hours of Time and the Additional Cost of Refrigerant Added During A/C Recharging
- Prevents Damage to the Rear Heat Shield
- Use with OEMTOOLS® 27309 3/4" Drive Torque Wrench and OEMTOOLS® 22398 18 mm Socket



### 24" Straight Edge

**OEM TOOLS**

SKU 949552  
25355 **49<sup>99</sup>**



MADE IN USA

- Use with a Feeler Gauge to Inspect for Distortion on Engine Blocks, Cylinder Heads, Fly Wheels, Main Bearing Saddles, Cam Bearing Saddles, Cam Covers and Bell Housings
- Constructed with 1/4" Thick Cold Rolled Steel
- Precision Ground Edge to +/- 0.001"
- Durable Powder-Coat Finish
- Hang Hole for Convenient Storage
- Includes: Reusable Protective Edge



## Engine Cylinder Hones

### BC 180SC Flex-Hone Tool Kit

SKU 213154  
BRM14353 **239<sup>99</sup>**

- 10 Piece Kit Features Flex-Hone Sizes: 10 mm, 1/2", 5/8", 3/4", 7/8", 1", 1-1/4", 1-1/2", 1-3/4" and 2"
- Complimentary Snap Back Hat and 1/2 Pint of Flex-Hone Oil



**BRM**

### Adjustable Engine Cylinder Hone Deglazer

**OEM TOOLS**

SKU OSB  
25041 **39<sup>99</sup>**

- Range: 2" to 7" (51 mm to 128 mm)
- Spring Tension Adjusting Nut for Positive Cutting Action at All Speeds
- Includes: 4" Medium Grit Stones



For OSB,  
Call 901-300-4878

SKU	Part #	Product	Cylinder Diameter		Price
			Metric	SAE	
341226	BRMBC30018	Flex-Hone™ GB	76 mm	3"	<b>54.99</b>
341232	BRMGB31412	Flex-Hone™ GB	83 mm	3-1/4"	<b>54.99</b>
341239	BRMGB31212	Flex-Hone™ GB	89 mm	3-1/2"	<b>59.99</b>
341317	BRMGB33412	Flex-Hone™ GB	95 mm	3-3/4"	<b>64.99</b>
341325	BRMGB41812	Flex-Hone™ GB	105 mm	4-1/8"	<b>69.99</b>
341332	BRMGB45812	Flex-Hone™ GB	118 mm	4-5/8"	<b>69.99</b>

**ADDITIONAL SIZES AVAILABLE - CALL US AT 901-300-4878 OR VISIT AZTOOL1.COM**

Prices subject to change without notice. Prices do not include applicable taxes, vehicles, tires, rims, installation or optional equipment as shown. Please do not return purchases to the store. For information regarding warranty, repair, or any questions or concerns, call 901-300-4878.

## Harmonic Balancer Tools

### Harmonic Balancer/Steering Wheel Puller

SKU OSB 25053 **28<sup>99</sup>**

- Removes Balancers, Steering Wheels, Pulleys and/or Gears with Tapped Holes
- Floating Swivel Helps Prevent Damage to Shaft End
- Includes: 5/16"-18 x 2" Bolts, 5/16"-18 x 2" Bolts, M8-1.25 x 80 mm Metric Bolts, 3/8"- 16 x 4" Bolts
- Heat Treated Yoke Forged from High-Strength Alloy Steel



For OSB, Call 901-300-4878

### Harmonic Balancer Puller

SKU OSB 25057 **49<sup>99</sup>**

**NEW**

- 2 and 3 Jaw Configuration for Use with 3, 4 and 6 Spoke Harmonic Balancers
- Angled Jaw Grips Harmonic Balancers Found on Gen 3 Coyote Engines as Well as Harmonic Balancers Found on Some Ford 7.3L, 3.5L and 2.5L Engines
- Also Ideal for Harmonic Balancers Found on Many 5.7L Dodge/Ram Hemi Engines



For OSB, Call 901-300-4878

### GM Harmonic Balancer Puller

**OEM TOOLS**

SKU 213102 **46<sup>99</sup>**  
25264

- **Time Saving Tool, No Need to Remove Radiator**
- Designed to Remove Harmonic Balancers without Tapped Holes
- GM Applications: 5.3 L, 5.7 LS1, 6.0 LS2, 6.2 LS3, 7.0 L
- Chrysler/Jeep/Dodge: 3.5 L V6, 3.6 L V6, 4.7 L V8, 5.7 L V8 and 6.1 L V8



### Universal Pulley and Fan Clutch Holder

SKU 547013 **59<sup>99</sup>**  
27281

- Fits Many Different Fan Clutches, Cam and Crank Pulleys with Slots or Holes
- Adjustable Diameter: 1-1/2" to 8-5/8"
- Pin Sizes: 6-10 mm, 8-11 mm, 10-12 mm and 11-16 mm
- Comes in Blow Mold Case

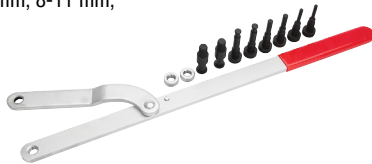

### Harmonic Balancer Installer

SKU 1103603 **41<sup>99</sup>**  
37144

- Use to Properly Install Harmonic Balancers without Damage
- Thread Adapters: 12 mm x 1.5, 14 mm x 1.5, 16 mm x 2.0, 7/16" x 20, 1/2" x 20, 9/16" x 18, 5/8" x 18 and 3/4" x 16

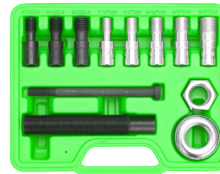

### Honda/Acura Crank Damper Holder Tool

SKU OSB 26507 **16<sup>99</sup>**

- For Removal and Installation of the Crank Bolt on Honda/Acura Engines (1990 - Newer)
- Designed to Hold Crankshaft Pulley to Install/Remove Crankshaft Pulley Bolt
- 50 mm Hex
- 1/2" Drive Works with Ratchet or Breaker Bar



For OSB, Call 901-300-4878

### Harmonic Balancer Puller Kit

SKU 818738 **36<sup>99</sup>**  
25090

**Unique Jaw and Returning Springs for Easy Positioning of the Puller**

- Includes: Puller Body, 3 Jaw Puller, 3 Jaw Retaining Pins, 3 Wave Washers, Pressure Screw
- Insert Rods: 4", 5-13/32", 6-1/2" and 7-13/32"
- Used on Many GM, Ford, Mitsubishi and Chrysler Engines



### Harmonic Balancer Puller

SKU 1103576 **31<sup>99</sup>**  
37187

- Includes: Yoke, Pressure Screw and Pulling Screws
- Floating Swivel Prevents Damage to Shaft Ends
- Ideal for Any Shop or Garage
- Pulling Balancers and More
- Heat-Treated for Strength and Durability



### Long Reach Harmonic Balancer/Pulley Installer for GM, Ford and Chrysler

SKU 1103550 **36<sup>99</sup>**  
37306

- Use to Install Crank Pulley or Underdrive Pulley on Many Late Model Ford, GM, Dodge and Chrysler Vehicles with V8 and V6 Engines
- Includes: M16 x 2.0 mm (GM), M14 x 1.5 mm (Dodge, Chrysler and Jeep), M12 x 1.75 mm (Dodge Chrysler and Jeep) and M12 x 1.5 mm (Ford)

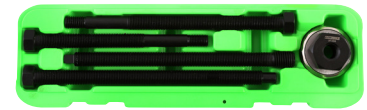

## Hex Oil Pump Primers

- Used to Prime the Lubricating System of a Rebuilt Engine Prior to the First Start, Preventing a Dry Start
- Connects to the Oil Pump Shaft Through the Distributor Hole
- For Use with 3/8" Reversible Drill

**OEM TOOLS**



**Ford 1/4"**  
SKU 534537 **5<sup>99</sup>**  
27061

**Ford 5/16"**  
SKU 534545 **5<sup>99</sup>**  
27062



## Piston Tools

### Piston Ring Compressor

SKU 013641 **24<sup>99</sup>**  
24682

- 1-1/2" Deep, Low Friction Wrinkle Band
- Fits 3" to 5" Pistons



### Piston Ring Expander Pliers

SKU 003509 **26<sup>99</sup>**  
25083

- Eliminates Piston Ring Damage and Distortion During the Installation and Removal Process Dipped Rubber Handles for Improved Grip
- Diameter Range: 3-1/8" (80 mm) to 4-5/8" (120 mm)



**OEM TOOLS**

### Piston Ring Compressors

**2-1/2" to 5"**  
SKU OSB 25033 **21<sup>99</sup>**

- Fits 2-1/2" to 5" Pistons

**3-1/2" to 7"**  
SKU OSB 25044 **24<sup>99</sup>**

- Fits 3-1/2" to 7" Pistons



For OSB, Call 901-300-4878

## Flywheel Locking Tool

### Flywheel Locking Tool

**OEM TOOLS**

SKU 1335793 **19<sup>99</sup>**  
25557

- Locks Flywheel in Place When Removing Harmonic Balancer on 6.6L Duramax Engines with Allison Automatic Transmissions
- Saves Time by Securing the Flywheel at the Transmission as an Alternative to Removing the Starter for Water Pump Replacement
- Use 36 mm 12 Point Socket with 3/4" Square Drive to Remove Harmonic Balancer Bolt and Retorque on Installation
- Toothed Pieces with Screws Work with Duramax 4500/5500 Trucks



# ENGINE SERVICE

## Diagnostics

### Compression Tester Gauge Set

SKU 1103601 **46<sup>99</sup>**  
37138

- Use to Test Compression 0 to 300 psi on 14 mm and 18 mm Spark Plug Ports and Determine Engine Mechanical Condition



### 8 Piece Noid Light Set

SKU 1103589 **29<sup>99</sup>**  
37161

- Includes: GM TBI, GM SCPI, GM PFI, Ford TBI, GEO TBI, Bosch PFI, Bosch Type 2 and GM Multec 2
- See-Through Design to Check Electrical Pulses

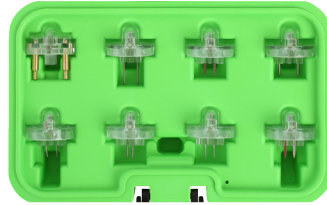

### Water Sensor Socket

SKU 607072 **24<sup>99</sup>**  
25369

- Used to Remove Water Sensor When Changing the Fuel Filter on GM 6.6L Duramax Diesel Engines 3/8" Square Drive
- GMC 6.6L DuraMax Diesel Engine Application Including Chevy/GMC Pickups (2001 and Newer) and Chevy/GMC Medium Duty Trucks (2003 and Newer)



OEM TOOLS

### Exhaust Back Pressure Tester/Gauge

SKU 1103604 **69<sup>99</sup>**  
37263

- Oxygen Sensor Adapter is M12 and M18 Thread
- 6' Hose Allows User to Test from Driver's Seat
- Test for Restricted Exhaust Systems

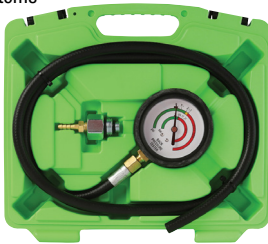

### Gas Engine Combustion Leak Tester

SKU 1103608 **25<sup>99</sup>**  
37145

- Test for Internal Combustion Leaks on Gasoline Engines
- Fluid Color Changes to Yellow When a Combustion Leak is Present
- Designed for Professional Auto Mechanics and Heavy Duty Applications
- Not for Use with Diesel Engines



Use with 25739  
Test Fluid Listed  
on Page 40

### Vacuum Pump Tester Power Steering and Brake Bleeder Set

SKU 1103570 **69<sup>99</sup>**  
37070

- Brake Bleeding Kit Bleeds Brakes, Clutches or Other Hydraulic Systems
- Kit Includes: Vacuum Pump Reservoir Jar with Transfer Lid, Storage Lid, Brake Bleeding Adapter Package, Steering Pump Adapters and Tubing



## Ford Triton Repair Kits

### Ford Triton Plug-Saver® Kit

SKU OSB **214<sup>99</sup>**  
MAR98140T

- Designed to Specifically Repair the Spark Plug Ports in 4.6, 5.4 and 6.8 Ford Triton Engines
- Repairs Worn, Damaged Threads
- Includes: Self Cutting Tap, Tool and 8 Inserts in a Sturdy Case

For OSB, Call 901-300-4878



marson

### Broken Spark Plug Remover Ford Triton 3 Valve

SKU 489173 **134<sup>99</sup>**  
LIS65600

- Includes a Unique Porcelain Pusher Tool and a Tapered Left-Hand Thread Remover for Removing the Broken Spark Plug without Leaving the Porcelain in the Engine Cylinder



Lisle

## Spark Plug Thread Repair

### Spark Plug Thread Repair Kit - Metric M14 - 1.25

SKU OSB **41<sup>99</sup>**  
25643

- Includes: High-Grade Tap, (3) Inserts and a Job-Specific Installation/Tang Break-Off Tool
- Returns Threads to Original Size
- Creates a Permanent and Wear-Resistant Thread

For OSB, Call 901-300-4878



### Tapered Seat Spark Plug Thread Repair Kit - Metric M14 - 1.25

SKU 141511 **29<sup>99</sup>**  
25647

- 3 Insert Lengths are Provided to Fit the Most Common Spark Plug Reaches
- Positive Mechanical Locking Feature Keeps Insert in Place
- Piloted Reamer Eliminates Need to Drill Out Threads and Ensures Correct Alignment
- Can Be Used to Repair Both Taper Seat and Gasket-Type Spark Plug Assemblies
- Includes: 2-Step Piloted Reamer Tap, 3 Inserts and Swaging Tool



OEM TOOLS

## Oxygen Sensor Thread Repair

### Oxygen Sensor Thread Repair Kit

SKU 010134 **169<sup>99</sup>**  
FIX38189-1

- No Need to Replace Exhaust Manifold
- Pilot Nose Tap Provided



FIX-A-THRED

## Head Bolt Thread Repair

### Metric Head Bolt Thread Repair Kit

SKU 010131 **164<sup>99</sup>**  
FIX35119S

- Extended Reach for Deep Threads
- Longer Length (33 x 1.5 mm) Inserts for Maximum Thread Engagement
- Applications: Cadillac, Honda, Toyota and Other Imports That Use M11 x 1.5 Head Bolts



FIX-A-THRED

## STOP the Knock!

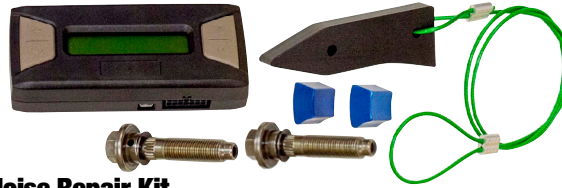

### Cam Phaser Noise Repair Kits Include: Ford Cam Phaser Noise Repair Kit

- Wedge Tool for Easier Installation
- Programmer with OBD-II Cable
- 2 OEM Quality Phaser Bolts
- 2 Lock Outs

SKU **OSB** LMEF1503V **699<sup>99</sup>**  
 • Fits Ford OEM Cam Phaser

**This Kit is the Only True, Long Term Repair for Ford Cam Phaser Noise on the Market**

Ford, Livernois and logos featured or referred to on this page are the property of their respective trademark holders | For OSB, Call 901-300-4878

### Exhaust Tools

#### Exhaust Manifold Spreader Set

SKU **504028** **33<sup>99</sup>**  
 25253TWO

- Use for Reinstalling the Manifold on Small-Block Chevrolets
- Simple Way to Expand Warped Manifold to Align Bolt Holes
- Helps Prevent Cross-Threading of Manifold Bolts
- Works Best When Used in Pairs or Install Before Removing Manifold to Prevent Misalignment



#### Manifold Drill Template - Ford 2V and 3V

SKU **213145** **89<sup>99</sup>**  
 25251

- Designed to Remove Broken Exhaust Manifold Studs
- For Ford Triton 2V and 3V Engines - 4.6L, 5.4 L and 6.8 L V10
- Drill Depth Gauge Marked on Each Adapter
- Interchangeable 2V and 3V Adapters
- Hi-Vis EVA Tray for Easy Storage and Organization
- Includes: Template, 2V Adapter, 3V Adapter, 2 Stud Alignment Pins, 3/16" and 1/8" Double-Sided Drill Bits and Stud Extractor



#### 2-1/8" x 3-7/16" Tailpipe Expander

SKU **OSB** **149<sup>99</sup>**  
 27028

- Expands Tailpipes so Mufflers and Tailpipes Can Be Fitted to the Exhaust System
- Extra-Long Hex Bar for Convenience
- Alloy Steel Construction for Strength and Durability
- Designed for Heavy Duty Applications



#### 1-1/2" to 2-7/16" Tailpipe Expander

SKU **OSB** **16<sup>99</sup>**  
 27027

For OSB, Call 901-300-4878

### Fan Clutch Tools

#### Fan Clutch Wrench Set

SKU **1103596** **99<sup>99</sup>**  
 37141

- Works on Many of the Ford, Mazda, Dodge, Lincoln, Mercury and Jeep Makes and Models with the Original Fan Clutch Assembly
- Includes Wrench Sizes: 40 mm, 48 mm, 54 mm, 68 mm, 72 mm, 76 mm and 83 mm



#### Fan Clutch Holding Tool

SKU **209526** **39<sup>99</sup>**  
 27171

- Holds Water Pump Pulley While Servicing Fan Clutch
- Adjustable Jaws Fit Most Water Pump Pulley Bolt Patterns, Including Pressed-On Pulleys
- Jaws Lock in Place



#### Fan Clutch Service Set for Mercedes-Benz and BMW

SKU **512958** **149<sup>99</sup>**  
 27224

- Removes Lock Nuts on Thermo Viscous Fans Found on Mercedes-Benz, BMW and Many Ford Models
- Special Open-Ended Spanner to Allow Removal and Replacement of the Radiator Fan Hub
- The 3-in-1 Design Allows Servicing of 3 Separate Areas of Repair, Eliminating the Need for 3 Different Tools
- Hub Securing Bar - Used for Securing Water Pump Hub from Rotating During R&R of Fan Clutch Nut
- Applicable: Mercedes M103, 104, 111, 119, 120 OM 602, 603, 605, 606; the 10 mm is Used for Adjusting A/C Belt Tension and R&R of Idler Pulley on Models 420, 560 with V-819 (1986 and Newer)
- Applicable: Mercedes M103 (6 CYL, M104 (6 CYL 4 VLV), M119 (8 CYL 4 VLV) M120 (12 CYL 4 VLV)



#### Fan Clutch Wrench Set

SKU **OSB** **29<sup>99</sup>**  
 26505

- Use on Ford Model Truck Clutch Fans 1984 to Current
- Wrench Sizes: 36 mm and 57 mm
- Use on 1984 to 1993 Ford 4.9 Liter E and F Series Truck Engines; 2.8 Liter Engines; 1988 to Current 2.9 Liter to 3.0 Liter Engines; 1990 to Current 4.0 Liter Engines



#### Pneumatic Fan Clutch Wrench Set

SKU **291409** **219<sup>99</sup>**  
 LIS43300

- Quickly Removes and Installs Fan Clutch When Repairing the Water Pump or Fan Clutch
- Includes Wrench Sizes: 32 mm, 36 mm, 40 mm; 7/8", 1-7/8" and 2"



### Alternator Tools

#### Alternator Decoupler Pulley Tool Kit

SKU **300124** **21<sup>99</sup>**  
 27261

- Works on Both Overriding Alternator Decoupler (OAD) and One-Way Clutch (OWC) Pulleys
- Tools May Be Used While the Alternator is On or Off
- Includes: 2 Pulley Sockets and 3 Shaft Bits
- Comes in a Sturdy Blow Mold Storage Case



#### Alternator Decoupler Pulley Service Set

SKU **1103629** **47<sup>99</sup>**  
 37275

- Removes and Installs Many Alternator Decoupler Pulleys on the Most Popular Vehicles
- Works on Both Overriding Alternator Decoupler (OAD) and One-Way Clutch (OWC) Pulleys

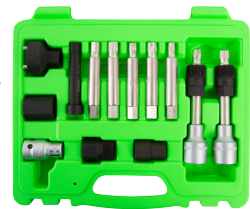

### Stretch Belt Tools

#### Stretch Belt Installation Tool

SKU **227301** **29<sup>99</sup>**  
 24363

- Works on Both Large and Small Pulleys
- Clamping Jaw Allows User to Position Serpentine Belt without the Belt Slipping Out of the Tool



#### Stretch Belt Remove and Installer

SKU **255866** **36<sup>99</sup>**  
 LIS59370

- Unique Magnetic Faces Hold the Tool in Place on the Pulley
- Compact, One Piece Tool Can Be Used on the Front or Back Side of the Pulley

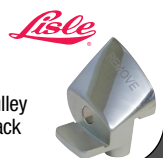

# CHASSIS & SUSPENSION

## Ball Joint Service Kits

### XL C-Frame Ball Joint Press Set

SKU 1142924 **129<sup>99</sup>**  
25105

- Ideal for Pressing Out Larger Ball Joints on Pick-Up Trucks: Toyota Tacoma and Tundra, Chevrolet 2500-3500 and Tahoe, Dodge Ram 2500-3500 and Ford F350-F550
- Extended C-Frame Allows Use of Multiple Larger Adapters That Standard C-Frame Presses Won't Fit
- C-Frame Constructed with Heavy Duty Forged Steel for Strength and Durability
- For Use with OEMTOOLS® Ball Joint Press Kits and Adapter Sets



Includes  
6" and 9"  
Pressure  
Screws

### 74 Piece Master Ball Joint Press Kit

SKU 1207895 **999<sup>99</sup>**  
37388

- Adapters for Almost Every Car, Van, SUV and Light Duty Truck
- Comprehensive Kit with 70+ Adapters and C-Frame
- Tough Heavy Duty C-Frame is Built to Last
- 2 Heavy Duty Molded Cases are Designed for Storage and Mobility



OEMTOOLS®

Easy to Read  
Manual for  
Finding  
Adapters  
Quickly  
and Easily



**BONUS**  
VALUE: \$108.99

### Hydraulic Ball Joint Separator

25219

With  
Purchase of:  
37388



Offer Good Through  
June 30, 2026

### 21 Piece Master Ball Joint Press Set

SKU 1142406 **189<sup>99</sup>**  
25104

- Removes and Replaces Press-Fit Upper and Lower Ball Joints on 2-Wheel Drive (2WD) and 4-Wheel Drive (4WD) Vehicles
- Includes Adapters with Specialized Cut-Outs to Maneuver Around Obstructions
- Includes Adapters Needed for Removing Upper and Lower Ball Joints on GM, Ford and Chrysler 2WD and 4WD Light-Duty Trucks, Vans and SUVs
- Heavy Duty Forged Steel Alloy C-Frame for the Toughest Jobs — Ideal for Seized Joints



### Master Ball Joint Installer/Remover Adapter Set

SKU 1103612 **109<sup>99</sup>**  
37310

- Includes All the Receiver Tubes and Removing/Installing Adapters Needed to Work on Many GM, Ford and Chrysler 2 and 4 Wheel Drive Pick-Ups, Vans and SUVs
- Works on Press-Fit Upper and Lower Ball Joints
- For Use with OEMTOOLS® Ball Joint Press Kits and Adapter Sets



### Ball/U-Joint Press with 4WD Adapter Set

SKU 1103607 **99<sup>99</sup>**  
37089

- Remove and Replace Ball Joints on Many Vehicles
- C-Clamp Frame Press Also Removes and Replaces U-Joints
- Includes Adapters to Service 1/2 to 3/4 Ton 4 Wheel Drive Vehicles Equipped with Dana 44 Series Front Axle



## Ball Joint Tools

### Ball Joint Separator

SKU 1340232 **35<sup>99</sup>**  
37308

- Used for Separating the Ball Joint from the Spindle Support Arm on Domestic and Import FWD Vehicles
- Adjustable for Different Size Ball Joints
- Max. Opening Range: 1-1/8" to 2-1/8"



### Low Profile Ball Joint Separator

SKU 1245676 **42<sup>99</sup>**  
25112

- Designed for Tight Access Where Many Ball Joint Separators Won't Fit
- For 2005+ Ford, Lincoln and Mercury Applications
- Impact Rated



### Polaris ATV Ball Joint Tool

SKU 1142310 **89<sup>99</sup>**  
24683

- For Removal and Installation of Upper and Lower Ball Joints on Sportsman XP, RZR and Ranger ATVs



OEMTOOLS®

### Hydraulic Ball Joint Separator

SKU 177718 **108<sup>99</sup>**  
25219

- Hydraulic Ram Rated to 8 Tons
- Jaw Capacity: 56 mm (2.25")
- Jaw Width: 22 mm (0.86")



Fast. Safe. Efficient.

### Ball Joint Separator

SKU 1207880 **20<sup>99</sup>**  
26553

- Separate Ball Joints from Spindle Support Arm
- Adjustable for Different Size Ball Joints
- Max. Opening Range: 1-1/8" to 2-1/8"
- Fork Opening Measures 7/8"
- Steel Construction with Black Oxide Pins
- Comes in a Sturdy Blow Mold Case



### 3/4" Drive Ball Joint Impact Socket

- Used on Chrysler/Dodge Cars, Light Trucks and Vans

**2-9/64"**

SKU 462494  
24215

**29<sup>99</sup>**



**1-59/64"**

SKU 662809  
24238

**29<sup>99</sup>**



# CHASSIS & SUSPENSION

TO ORDER, contact your Commercial Sales Manager or go to [AutoZonePro.com](http://AutoZonePro.com)

CHASSIS & SUSPENSION

## Spring Compressors

OEM TOOLS®

### Floor Mounted Strut Compressor

SKU 1405961 **299<sup>99</sup>**  
37037

- 2,200 Lb. Capacity
- Easy-to-Adjust Bracket Conforms to Spring Rate and Diameter
- Handles Spring Coils 3.5" to 8.75" and Up to 5/8" Diameter
- Max. Spring Height: 19"
- Can Be Securely Mounted to the Floor

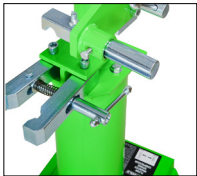

Bracket Design Easily Adjusts to Accommodate a Wide Range of Vehicle Strut Sizes

No Special Adapters Required

Floor Mounting Hardware Not Included

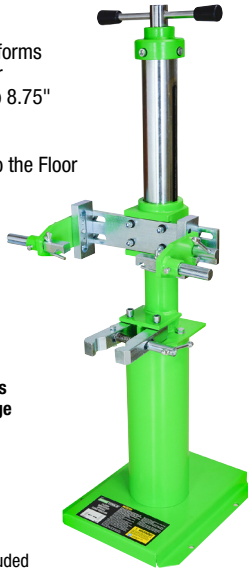

### Model 7600 Strut Spring Compressor

SKU 547959 **1,299<sup>99</sup>**  
BRA7600

- Handles the Toughest Applications
- Min./Max. Spring Diameters: 3.5"/11.5"
- No Adapters Required

OEM Approved by Major Automakers

### Cart for BRA7600

SKU 547960  
BRA00-0137  
**629<sup>99</sup>**



### Mechanical Strut Compressor

SKU OSB  
QSPMSC-1000  
**Call for Price**

- Designed to Handle Any Size Spring and Strut Assembly
- Adjustable Extra Strong Clamps for a Perfect Grip
- Top Mounted Tool Tray
- Standard Wall Mount
- Safety Guard Included
- Optional Floor Mount and Third Hand Support Kits

For OSB, Call 901-300-4878



### Coil Spring Compressor

SKU 1103643 **64<sup>99</sup>**  
37035

- Use to Safely Compress the Coil Spring on Most Cars and Light Trucks
- Can Also Be Used When Installing Coil Spring Spacers

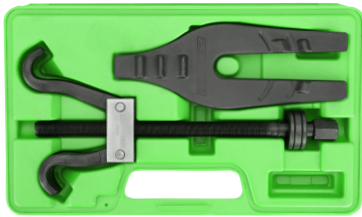

### Coil Spring Compressor Set

SKU 1103614 **39<sup>99</sup>**  
37200

- Forged Construction for Strength and Durability
- Removes and Installs Coil Springs Quickly and Safely
- Compresses Coil Springs on Most Passenger Cars and Pickup Trucks

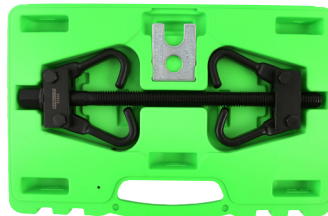

### Strut Spring Compressor

SKU 1207884 **39<sup>99</sup>**  
37036

- Used to Compress Strut Springs During Cartridge Replacement
- Safety Latches Lock Spring in Place During Compression Hooks are Forged and Center Screw is Hardened for Longer Life
- Thread Length: 9"
- Can Be Used with Varying Coil Diameters Up to 5/8"



## Suspension

OEM TOOLS®

### GM Upper Control Arm Knock Out Tool

SKU 420336 **15<sup>99</sup>**  
24210

- Services Chevrolet and GMC 1/2, 3/4 and 1 Ton, 2 and 4 Wheel Drive Trucks (1989 to 2001) and All Wheel Drive Chevrolet Astro and GMC Safari Vans (1990 to 2002)



## Shock Socket

OEM TOOLS®

### Volvo Shock Retaining Nut Strut Removal Socket Tool

SKU 300125 **20<sup>99</sup>**  
24365

- Remove and Install Top Shock Retaining Nut on Volvo Models
- Applications Include: Volvo C70 (1999-2004), Volvo S40 (2000-2004), Volvo S60 (2001-2004), Volvo S70 Non-Turbo (1999-2000), Volvo S70 Turbo (1999-2000), Volvo S80 (1999-2004), Volvo S80 V8 (2007-2008), Volvo S80 Turbo (1999-2006), Volvo V40 (2000-2004), Volvo V70 (1999-2007), Volvo XC90 (2003-2010)



## Front End Service Kit

OEM TOOLS®

### 5 Piece Front End Service Kit

SKU 1267952 **89<sup>99</sup>**  
26554

- Large and Small Pitman Arm Puller for Ball Joint Application
- Two Ball Joint Separators
- Three Tie Rod Pullers



## Torsion Bar Tool

OEM TOOLS®

### GM, Ford, Chrysler Torsion Bar Tool

SKU 1103600 **64<sup>99</sup>**  
37278

- Safely Loads and Unloads 5-Lug, 6-Lug and 8-Lug GM, Dodge and Ford Torsion Bar Suspensions for Key Replacement
- Extended Long Reach "C-Clamp" for Use with 2011 and Higher GM Heavy Duty Trucks
- Includes Ford/Dodge Adapter



Prices subject to change without notice. Prices do not include applicable taxes, vehicles, tires, rims, installation or optional equipment as shown. Please do not return purchases to the store. For information regarding warranty, repair, or any questions or concerns, call 901-300-4878.

AZG0226

65

# CHASSIS & SUSPENSION

## Hub Bearing

### Brake Drum and Rotor Puller

SKU 1125878 **129<sup>99</sup>**  
25106

- Use on Most FWD and AWD (Some RWD) Vehicles.
- Use with Impact Wrench to Remove Hubs, Drums and Brake Rotors
- Includes 3 Hub Adapters for Use with Most Common Hub Sizes and Types
- Jaw Spread Up to 14" with 5" Reach
- Durable Forged Frame Rated to 7 Tons of Pulling Force for the Toughest Jobs
- Drum and Rotor Pulling Arms Feature with Raised Stops for Use with Ratchet Straps (Not Included)
- Easily Adjust the Arms and Set Puller in Place for Tough Pulling Jobs in Tight Spaces

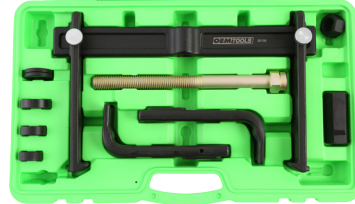
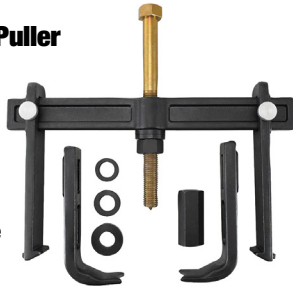

### Master Wheel Hub and Bearing Remover and Installer Set

SKU 1103635 **399<sup>99</sup>**  
37342

- For Removal and Installation of Front Wheel Hub on Most Vehicles
- Self Centering Design is Incredibly Durable and Easy to Use
- Works on Front, Rear and All-Wheel Drive Vehicles
- Heavy Duty Thrust Bearing Reduces Effort and Extends the Life of the Pressure Screw
- Includes: Adapter Shoes, Pusher Washers, Receiver Sleeves, Nut-Bolt and Heavy Duty Bearing



### Wheel Hub Removal Tool

SKU 1245618 **89<sup>99</sup>**  
25749

- Ideal For Removing a Frozen Hub Assembly without Damaging the Axle
- For Use on Many Axle Bolted Hubs Including Five, Six and Eight Lug Hubs
- Constructed from High-Quality, Impact-Resistant and Corrosion-Resistant Steel
- 2-5/8" Center to Center Hole Pattern
- 3/4" Steel Backing Plate and Reinforced Striking Plate for Long Life



### Front Wheel Drive Hub Puller

SKU OSB **27<sup>99</sup>**  
27037

- Fits Most Domestic and Import Vehicles
- Yoke and Bolt are Threaded 5/8" x 18
- Heat-Treated Pressure Screw for Toughness



Slide Hammer Not Included

For OSB, Call 901-300-4878

## Tie Rod Tools

### Master Inner Tie Rod Tool Set

SKU 344979 **69<sup>99</sup>**  
27178

- Works on Both Small Cars and SUVs
- Tube Handle Has an Inner Diameter of 2.125" to Service Small Cars, Pickups and Large SUVs
- Includes 12 Crowfoot Style Adapters, Sizes: 29 mm, 1-3/16", 1-1/4", 32.5 mm, 1-5/16", 33.6 mm, 1-3/8", 1-7/16", 1-1/2", 38.4 mm, 40 mm and 42 mm



### Tie Rod End Remover

SKU 209525 **25<sup>99</sup>**  
27175

- Comes with Pressure Screw Tip Swivels for Damage Free Results
- Will Not Damage Tie Rod End Dust Boot
- Rust Resistant Finish



### Inner Tie Rod Tool Kit

SKU 217377 **45<sup>99</sup>**  
27185

- Removes and Installs Tie Rod End on Rack and Pinion Steering
- Includes: 3/16", 5/16" and 7/16" Adapters



### Inner Tie Rod Tool

SKU 291414 **119<sup>99</sup>**  
LIS45750

- 6 Sizes: 1-3/16", 1-1/4", 1-5/16", 1-7/16", 1-1/2" and 33.6 mm



## Pitman Arm Puller

### Pitman Arm Puller for Light Trucks

SKU OSB **49<sup>99</sup>**  
27170

- Services Cars and Light Trucks 3/4 Ton
- Features Forged Adjustable Jaws and Two Clamp Bolts That Lock Jaws Together
- Pressure Screw Has Ball Head Designed for Striking



For OSB,  
Call 901-300-4878

## Pickle Forks

### Stepped Pickle Fork Set

SKU 291410 **84<sup>99</sup>**  
LIS41400

- 6 Tools in One
- Includes: 11/16", 15/16", 1-1/8" Forks and 2 Handles



### 5 Piece Tie Rod and Ball Joint Set

SKU 1103626 **49<sup>99</sup>**  
37201 REG. \$69.99

- Used to Remove Tie Rods and Ball Joints
- Includes: 11" x 1-1/8", 11-3/4" x 1-5/8", 11-5/8" x 1-7/16", 16" x 11/16" and 16" x 15/16"

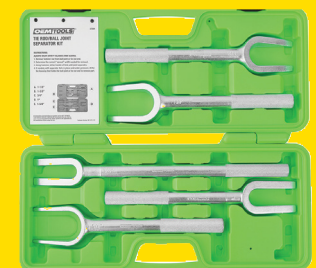

Offer Good Through  
June 30, 2026

# CHASSIS & SUSPENSION

TO ORDER, contact your Commercial Sales Manager or go to [AutoZonePro.com](http://AutoZonePro.com)

CHASSIS & SUSPENSION

## CV Axle Nut Sockets

### 12 Pt. 39 mm Axle Nut Socket

SKU OSB 27321H **29<sup>99</sup>**

- 1/2" Dr., 39 mm, 12 Point Size Fits Toyota Trucks, SUVs and Others



For OSB, Call 901-300-4878

See [AZTOOL1.com](http://AZTOOL1.com) for Full Line of CV Axle Nut Sockets

## Axle Nut Socket Sets

- Includes Sizes: 29, 30, 32, 34, 35, 36, 38 and 39 mm

### 6 Pt.

SKU 1103577 37320 **84<sup>99</sup>**



### 12 Pt.

SKU 1103460 37321 **74<sup>99</sup>**



OEM TOOLS®

## Bushing Tool Set

### Manual Bushing Installation and Removal Tool Set

SKU 298214 27212 **249<sup>99</sup>**

- Comprehensive Kit for Fast and Effective Removal/Installation of Wheel Bearings/ Suspension Bushings and Seals
- Allows the Technician to Service a Wide Range of Bushings without Removing Components from the Vehicle
- Comes with 20 Sleeves for Hundreds of Combinations
- External Sleeve Diameter: 44, 46, 48, 50, 52, 54, 56, 58, 60, 62, 64, 66, 68, 70, 72, 74, 76, 78, 80 and 82 mm

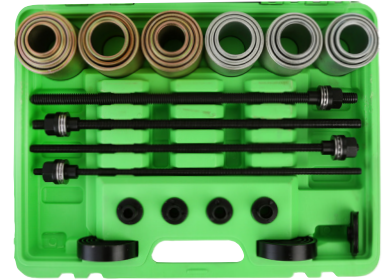

OEM TOOLS®

## Axle Tools

### CV Axle Puller Adapter

SKU OSB 27058 **11<sup>99</sup>**

- Works with OEMTOOLS 37033, 37191, 27085, 27033, 27202 and Other Slide Hammer Pullers with 5/8" x 18 Threads



For OSB, Call 901-300-4878

### CV Axle Popper Set

SKU 1189082 37305 **36<sup>99</sup>**

- Includes: Axle Shim Tool and Fork/Wedge Tool
- Length: 13-3/4"
- Used to Remove Axles from the Transmission, Ball Joints in the Suspension System and Tie Rods
- Fork Design Allows Mechanic to Exert Force Evenly on Both Sides of the Axle



### 5 Lb. Slide Hammer

SKU 1103572 37033 **59<sup>99</sup>**

- Use to Pull Bushings, Seals, Sleeves, Bearings, Flange-Type Rear Axles, Front-Wheel Drive Hubs, Dents and Pressed-In Bolts with Two or Three Jaw Puller Options
- Slide Rod is 3/4" x 16 Standard Threads



OEM TOOLS®

### 4WD Spindle Puller

SKU 143436 27104 **28<sup>99</sup>**

- Use with OEMTOOLS Slide Hammer 27033
- Fits Most Spindles 1-1/2", 1-5/8" and 2" on 4 Wheel Drive Vehicles
- Heat-Treated for Strength
- Will Fit on 2 Puller Size Shafts 1/2" x 20 Threads and 5/8" x 18 Threads



### Rear Axle Puller Set

SKU 094801 27202 **89<sup>99</sup>**

- Use for Flange-Type Rear Axle and Bearing Removal on Most Late Model Passenger Cars and Light Trucks
- Slide Rod and Adapters are 5/8" x 18 Standard Threads

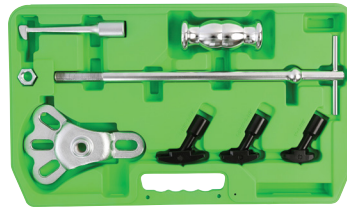

### Axle Spindle Threading Set

SKU 1103645 37233 **65<sup>99</sup>**

- Use to Clean or Repair Axle Threads
- Set Comes with a Special Twist Shape That Provides Easier and Quicker Work
- Sizes Included: M20 x 1.25, M20 x 1.50, M22 x 1.00, M22 x 1.50, M24 x 1.50, M24 x 2.00, 13/16" x 20 UNEF, 3/4" x 20 UNEF and 27 mm Extension Bar



## Seal Tools

### Transmission/Transaxle Plugs

SKU 298196 24490 **19<sup>99</sup>**

- Includes 5 Plugs to Seal Both Transmissions and Transaxles on Most Import and Domestic Vehicles
- Stepped Design for Retention and Positive Sealing
- Includes: Side Gear Centering Pin for Ford Transaxles



### Seal Puller

SKU OSB 25014 **11<sup>99</sup>**

- 2 Tops Fit All Seal Sizes
- Pops the Seal Out Every Time
- No Pounding or Hammering
- Protects Bearings and Races
- Rubber Handle



For OSB, Call 901-300-4878

OEM TOOLS®

### Bearing Race and Seal Master Driver Set

SKU 1103639 37119 **39<sup>99</sup>**

- Installs Most Standard Wheel Bearings and Races
- Includes Driver Sizes: 1.565", 1.750", 1.965", 2.325", 2.470", 2.555", 2.830", 2.995", 3.180" and Handle



### Universal Seal Installer Set

SKU 818737 25082 **30<sup>99</sup>**

- Knurled Long Handle
- Includes: 3" Driver, 2.5" Driver, Short Handle, Long Handle, Spider Insert, 5/16" x 1" Cap Screw, Large Spider, Small Spider and Washer
- Long Handle Provides Good Flexibility When Installing Pinion Seals



## Socket Press

### C-Frame Socket Press Set

SKU 012659 24537 **269<sup>99</sup>**

- Any Socket with 1/4", 3/8" or 1/2" Drive Can Be Used in Any Combination for Use on Virtually All Cars, ATV/UTV/SxS, Light Duty Trucks and Farm Machinery
- Set Includes Flat Anvil Attachments for General Pressing Jobs
- Capacity 2.5 Ton



OEM TOOLS®

Prices subject to change without notice. Prices do not include applicable taxes, vehicles, tires, rims, installation or optional equipment as shown. Please do not return purchases to the store. For information regarding warranty, repair, or any questions or concerns, call 901-300-4878.

AZG0226

67

# CHASSIS & SUSPENSION

## U-Joint Tools

OEM TOOLS®

### U-Joint Pullers

- Easily Removes Seized U-Joint Cups on Most Passenger Vehicles and Light Duty Trucks
- Does Not Damage the Driveshaft, Yokes, Joints or Bearing Cups

### Automotive

SKU 949561 **69<sup>99</sup>**  
24539

- Bearing Cup Outside Diameter: 1" to 1.25"

### Intermediate

SKU 949565 **99<sup>99</sup>**  
24548

- Bearing Cup Outside Diameter: 1.25" to 1.7"

### Heavy Duty

SKU 041474 **89<sup>99</sup>**  
24538

- Bearing Cup Outside Diameter: 1.5" to 2.2"



### Automotive Bearing Cup Installer

SKU 949571 **39<sup>99</sup>**  
24549

- For the Installation of Bearing Cups on Light-Duty and Medium-Duty U-Joints
- Efficiently Install 2 Bearing Cups in One Process
- Contact Points Feature Magnets to Retain Bearing Cups During Operation



## Spindle Nuts

### GM Axle Hub Nut Socket

SKU 298219 **23<sup>99</sup>**  
25967

- Applications: GMT900 Silverado, Sierra HDCS, 2-Wheel (2WD) and 4-Wheel (4WD) Drive Cheyenne, Silverado, Escalade, Sierra and Avalanche Trucks with 10.5" or 11.5" Ring Gear
- Has 9 Pins to Fit GM Style Retaining Nuts
- Unapproved Methods Can Damage the Bearing or Result in Shorter Service Life



### Dodge Hub Locknut Socket

SKU 344964 **14<sup>99</sup>**  
25968

- Fits Dodge 1/2-Ton Pickup Trucks (1994-Newer) with Dana 44 Front Axle and Dana 60 Axle with a Vacuum Disconnect
- Designed to Accommodate the 1-11/16" (43 mm) Wheel Bearing Retaining Nut Which is Recessed into the Hub



### Toyota 4 Pin Hub Locknut Socket

SKU 298224 **12<sup>99</sup>**  
25969

- Services High Torque Locknuts on Toyota 4WD Vehicles Having Free Wheel (Lock Out) Hubs
- Tacoma (1995-Newer); T100 and 4Runner (1996-Newer)
- Improved Design with Solid Pins for Increased Durability



### Ford Rear Axle Nut Wrench

SKU 1392337 **24<sup>99</sup>**  
27353

- Services 2003-Newer Ford F-250, F-350 and F-450 Super Duty Trucks with 10-1/2" Rear Axle
- Same as Ford Part Number 205-448
- Use with a 1/2" Drive Ratchet or Breaker Bar



### 1/2" Drive Socket Bearing Locknut

SKU 231203 **16<sup>99</sup>**  
25243

- Fits Adjusting Nuts Found on Ford F150 Trucks (1995 to 1996) and Full Sized Broncos with Automatic Locking Hubs



### 4WD Ford Spindle Socket, 66.5 mm x 80 mm

SKU 603346 **19<sup>99</sup>**  
25965

- Fits Ford F-Series 1/2-Ton Truck and Full-Size Bronco with Manual Hubs; 1995-Newer Ford F-Series 3/4-Ton and 1-Ton Trucks with Manual Hubs; 1959-85 Ford F-Series 1/2- and 3/4-Ton Trucks and Full-Size Bronco; 1960-90 GM 1/2-Ton Truck and Full-Size Blazer/Jimmy; 1969-89 Dodge 1/2-Ton Truck with Manual Hubs; 1969-72 International 1/2-Ton Truck
- 1/2" Sq. Drive



### 4WD Ford - Dodge Spindle Socket, 76 mm x 80 mm

SKU 603347 **22<sup>99</sup>**  
25966

### Toyota 8 Pin Front Hub Locknut Socket

SKU 298205 **22<sup>99</sup>**  
25962

- Allows for Easy Removal and Installation of Front Hub Lock Nut without Damage to the Nut
- Applications: Toyota 4Runner 2WD (2007 to 2014), Toyota Sequoia (2008 to 2014), Toyota Tundra (2007 to 2014)
- 3/4" Drive



## Power Steering

### Power Steering Pulley Remover/Installer - Ford, GM, Chrysler

SKU 1103578 **32<sup>99</sup>**  
37031

- Includes 2 Screws for Use on Most Ford, Chrysler, GM and VW Power Steering Pulleys
- Pulls Pulleys on GM Belt Driven Vacuum Pumps and Pressed-On Water Pump Pulleys of GM V6 Engines



### Steering Wheel Puller

OEM TOOLS®

SKU 1103540 **42<sup>99</sup>**  
37182

- Designed for All Major Makes and Models
- Sizes Included: 1/4" x 28, 8 mm x 1.25, 5/16" x 18, 5/16" x 24, and 3/8" x 16



## Clutch Tool

OEM TOOLS®

### Self-Adjusting Clutch Tool Kit

SKU OSB **549<sup>99</sup>**  
27209

- For Assembling and Fitting Self-Adjusting Clutches
- Used on: Audi, BMW, Fiat, Mercedes-Benz, Renault, Vauxhall/Opel and Volvo
- 38 Components
- Comes in Sturdy Blow Mold Case



For OSB,  
Call 901-300-4878

### Vacuum Pump Tester, Power Steering and Brake Bleeder Set

SKU 1103570 **69<sup>99</sup>**  
37070

- Includes: Vacuum Pump Reservoir Jar with Transfer Lid, Storage Lid, Brake Bleeding Adapter Package, Steering Pump Adapters and Tubing



### Power Steering Bleeder Set

SKU 434716 **26<sup>99</sup>**  
27311

#### Reduce Comebacks

- Eliminate Trapped Air in Power Steering and Brake Systems Following Repairs or Fluid Changes
- Includes: 2 Tapered Rubber Adapters to Fit Most Power Steering Pumps and Reservoirs
- Works with a Hand Vacuum Pump



## Drive Line Tool

OEM TOOLS®

### 1/2" Drive (12 mm) Ford Drive Line Impact Socket

SKU 420319 **19<sup>99</sup>**  
24212

- Applications Include Many Ford Drive Line Bolts
- 12 mm, 12 Pt.



## Floor Jacks

### 2-1/2 Ton Aluminum/Steel Hybrid Floor Jack

SKU 1417557 **249<sup>99</sup>**  
24869

- Aluminum and Steel Frame Construction Provides the Benefit of Strength Along with Light Weight
- Padded Jack Handle and Saddle Pad to Prevent Damage to Vehicle
- Dual Pump Design for Quicker Lifting
- Nylon Casters to Protect Sealed Floor Surfaces and Dealer Showrooms
- Min. Height: 3-1/2"
- Max. Height: 19-1/4"
- Length: 25-1/2"
- Weight: 58.2 Lb.

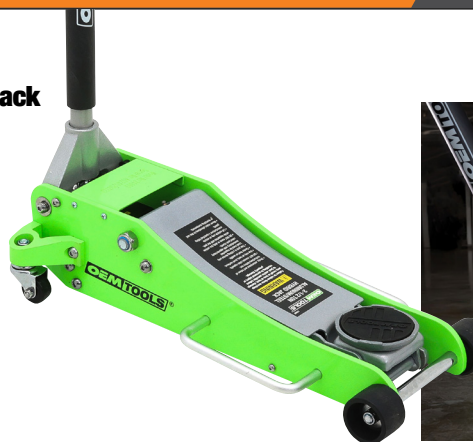

**OEMTOOLS®**

**3 1/2" ↓  
LOW PROFILE**

**↓  
PADDED HANDLE**

### 4 Ton Hydraulic Service Jack

SKU 1525558 **249<sup>99</sup>**  
29003

- Dual Piston Hydraulic System for Quicker More Efficient Lifting
- Nylon Casters Protect Sealed Floor Surfaces and Dealer Showrooms
- Meets ASME PASE-2019 Standards
- 4.3" Saddle Provides Generous Lifting Area and Secure Grip
- Min. Height: 4-3/8"
- Max. Height: 20-1/4"
- Weight: 98.3 Lb.

**20 1/4" ↑  
MAX HEIGHT**

**↓  
PADDED HANDLE**



### 3-1/2 Ton Low Profile Floor Jack

SKU 757109 **279<sup>99</sup>**  
24837

- Dual Pump Design for Quicker Lifting
- Min. Height: 3-3/4"
- Max. Height: 20-1/2"
- Length: 27-1/8"
- Weight: 85.8 Lb.

**3 3/4" ↓  
LOW PROFILE**

**↓  
PADDED HANDLE**



### 3 Ton Long/Low Signature Service Jack

SKU 1407611 **299<sup>99</sup>**  
24868

- Extra Long and Low Profile is Great for Low Clearance Vehicles, Pickups and SUVs
- Padded Jack Handle and Saddle Pad to Prevent Vehicle Damage
- Dual Pump Design for Quicker Lifting
- Nylon Casters to Protect Sealed Floor Surfaces and Dealer Showrooms
- Min. Height: 3-3/8"
- Max. Height: 24-1/4"
- Length: 31-3/8"
- Weight: 100.3 Lb.

**3 3/8" ↓  
LOW PROFILE**

**↓  
LONG REACH**

**↓  
PADDED HANDLE**



### 3 Ton Low Profile Jack

SKU 1597793 **179<sup>99</sup>**  
29005

- Low Profile Professional Quality Floor Jack for Low Clearance Vehicles
- 3-1/8" Minimum Height is Ideal for Sports Cars, Lowered Vehicles, and Lifting Vehicles with Flat Tires
- 4.3" Saddle with Jack Support Pad and Foam Handle Cover to Prevent Damaging Vehicle
- Overload and Bypass Safety Valves Prevent Use Beyond Rated Capacity and Over-Extension
- Max. Height: 19-3/4"
- Length: 26-1/4"
- Weight: 73.7 Lb.

**3 1/8" ↓  
LOW PROFILE**

**↓  
PADDED HANDLE**

**Ideal for Sports Cars, Lowered Vehicles, and Lifting Vehicles with Flat Tires**



### 2 Ton Off-Road Jack

SKU 1525571 **289<sup>99</sup>**  
29004

- Full Length Skid Plate Provides Stability in Soft or Unstable Materials Such as Sand or Gravel
- Heavy Duty Oversized Wheels are Ideal for Navigating on Rough or Uneven Surfaces
- High Lift Adapter Extension for Additional Lift Height Up to 24-3/16" Provides Access to Lifting Points for Off Road Vehicles
- Dual Piston Hydraulic System for Quicker, More Efficient Lifting
- Min. Height without Extension: 6-1/8", with Extension Stage: 11-1/4"
- Max. Height without Extension: 17-15/16", with Extension Stage: 24-3/16"
- Weight: 59.5 Lb.

**24 3/16" ↑  
MAX HEIGHT**

**↓  
PADDED HANDLE**



4-Position Locking Adjustable Height Extension

Full-Length Skid Plate

**Secure Lock Detent for Safety and Comfort During Transportation and Operation**



**Heavy Duty Oversized Wheels**



**Carry Handle for Portability**



**Locking Adjustable Height Extender**

All OEMTOOLS® Jacks on this page include overload and bypass safety valves and meet ASME PASE 2014 Safety Standards.

Prices subject to change without notice. Prices do not include applicable taxes, vehicles, tires, rims, installation or optional equipment as shown. Please do not return purchases to the store. For information regarding warranty, repair, or any questions or concerns, call 901-300-4878.

# JACKS & HYDRAULICS

## Wheel Dollies

### Mechanical Vehicle Position Dollies

- Easily Lift and Move Vehicles Up to 6,000 Lb.
- 1,500 Lb. Capacity Each

#### Set of 2 Dollies

SKU 1089031  
24793

**399<sup>99</sup>**



### Set of 4 Dollies with Storage Cradle

SKU 1414391  
69000

**699<sup>99</sup>**

REG. \$899.97

**SAVE OVER \$199**

When You Buy the Set



OEM TOOLS®

### Hydraulic Vehicle Position Dollies

- Easily Lift and Move Vehicles Up to 6,000 Lb.
- 1,500 Lb. Capacity Each

#### Set of 2 Dollies

SKU 298098  
24855TWO

**469<sup>99</sup>**

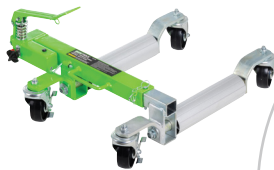

### Set of 4 Dollies with Storage Cradle

SKU 696485  
68986

**749<sup>99</sup>**

REG. \$1,039.97

**SAVE OVER \$289**

When You Buy the Set



### 1500 Lb. Wheel Dollies Set of Two

SKU OSB 24858 **119<sup>99</sup>**

- Great for Moving Cars, Trucks, Trailers and Lawn Tractors
- 4 Swivel Nylon Casters Give Mobility in All Directions, Roll Smoothly and are Safe for Epoxy Floors
- HD Steel Plate Construction for a Long Life
- 2 Casters on Each Dolly Have Locking Mechanisms

For OSB, Call 901-300-4878

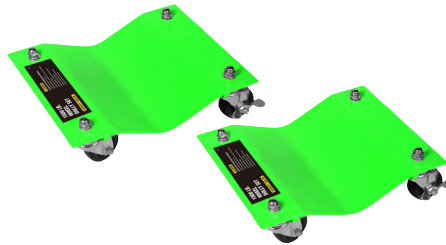

### Vehicle Position Dolly Cradle

SKU 544800 24856 **99<sup>99</sup>**

- Neatly Secure and Store Up to 4 Vehicle Car Dolly Jacks



Price does not include jacks

## Air Hydraulic Jacks

OEM TOOLS®

### 20 Ton Air Hydraulic Bottle Jack

SKU 544795 24850 **249<sup>99</sup>**

- Can Be Operated with Air or Manually
- Height: 10.25" to 20.1"
- Extension Screw Adjustment: 3.15"
- Meets or Exceeds ASME PASE-2019 Standards



### 22 Ton Air Hydraulic Truck Jack

SKU 544796 24851 **599<sup>99</sup>**

- Compact, Low Profile Design Easily and Safely Fits Between Wheels of Tandem Axle Vehicles
- Ram Travel: 4-15/16"
- Extension Screw Adjustment: 4"
- Min. Height: 8-3/4"
- Max. Height: 17-11/16"



Hydraulic Jacks Built for Performance and Ease of Use

### 35 Ton Air Hydraulic Axle Jack

SKU 954200 AFF536 **1,869<sup>99</sup>**

- Unique Motor Design Advances Ram to Load Faster
- Air Assisted Lowering and Dual Return Springs Provide Controlled and Easy Descent
- Safety Overload System Prevents Jack from Being Used Beyond its Rated Capacity
- Corrosion Resistant Aluminum and Nylon Composite Air Motor



## Jack Stands

### 3 Ton Jack Stands (Pair)

SKU 757122 24852 **99<sup>99</sup>**

- Min. Height: 11"
- Max. Height: 16-1/2"
- Meets or Exceeds ASME PASE-2019 Standards



### 6 Ton Jack Stands (Pair)

SKU 1580891 24788 **99<sup>99</sup>**

- Large Welded Foot Pads Provide Extra Stability and Resist Sinking into Asphalt and Similar Surfaces
- Recessed Saddle for a Secure Placement
- Self-Locking Ratchet Allows Safe and Easy Adjustment
- Features Locking Pin for Additional Security When Under Load
- Max. Height: 23-7/16"
- Min. Height: 15-1/2"
- Meets or Exceeds ASME PASE Standards



### 22 Ton Heavy Duty Axle Stands (Pair)

SKU 757098 24854 **249<sup>99</sup>**

- Min. Height: 12-1/4"
- Max. Height: 19-3/4"
- Adjustable Pin Design
- Features Handle for Transport and Positioning
- Large V-Shaped Saddles Center Lift Points for Secure Placement
- Meets or Exceeds ASME PASE-2019 Standards



OEM TOOLS®

# JACKS & HYDRAULICS

TO ORDER, contact your Commercial Sales Manager or go to [AutoZonePro.com](http://AutoZonePro.com)

JACKS & HYDRAULICS

## Transmission Jacks

### 1,000 Lb. Telescopic Transmission Jack

SKU 544786 **369<sup>99</sup>**  
24840

- Load Capacity: 1,000 Lb.
- Lowered Height: 51"
- Raised Height: 70"
- 2-Way Adjustable Saddle
- Heavy Duty Ram with Controlled Release Feature



70" REACH

### 1 Ton 2 Stage Telescoping Transmission Jack

SKU 1142678 **999<sup>99</sup>**  
26842

- Second Stage Capacity: 2,000 Lb.
- Lowered Height: 37.5"
- Raised Height: 76"
- 4-Way Adjustable Saddle
- Internal Shaft Retention to Prevent Leaks and Dirt Intrusion



76" REACH

Foot Pedal Pump and Release for Hands-Free Operation

### 1,100 Lb. 2 Stage Telescoping Transmission Jack

SKU 1089028 **899<sup>99</sup>**  
24790

- Second Stage Capacity: 1,100 Lb.
- Lowered Height: 37"
- Raised Height: 76.4"
- 4-Way Adjustable Saddle
- Fast Lifting Pump



76" REACH

Foot Pedal Pump and Release for Hands-Free Operation

### 1,100 Lb. High Lift Transmission Jack with Foot Pump

SKU 750006 **449<sup>99</sup>**  
24844

- Load Capacity: 1,100 Lb.
- Lowered Height: 47"
- Raised Height: 79"
- 2 Way Adjustable Saddle
- Spring-loaded Release Valve Stops Lowering When You Let Go



79" REACH

### 1 Ton Telescoping Transjak™ Transmission Jack

SKU 902478 **979<sup>99</sup>**  
RANRTJ1

- Capacity First Stage: 2,000 Lb.
- Capacity Second Stage: 1,000 Lb.
- Lowered Height: 37"
- Raised Height: 71"



71" REACH

Ranger

### 1-1/2 Ton Telescoping Transmission Jack

SKU 902484 **1,029<sup>99</sup>**  
RANRTJ3000

- Capacity First Stage: 3,000 Lb.
- Capacity Second Stage: 2,000 Lb.
- Lowered Height: 35-1/2"
- Raised Height: 71-1/2"



71-1/2" REACH

Ranger

### 1,100 Lb. Air Assist Transmission Jack

SKU 954225 **1,699<sup>99</sup>**  
AFF3052A

- 2 Stage Telescopic Ram Designed for Medium Truck Transmissions, Transfer Cases and Differentials
- Chrome Plated Pump Core and Piston Rod Reduces Friction and Provides Long Service Life
- Powder Coat Finish Provides Resistance to Corrosion, Chemicals and Scratches
- Adjustable Saddle with Corner Bracket and Safety Chain
- Double Pump Hydraulic System for Quick Lift Operation
- Adheres to ASME 2014



78" REACH

AFF3052A

### 800 Lb. Low-Profile Transmission Jack

SKU 544789 **399<sup>99</sup>**  
24845

- Fully Adjustable Saddle Adapts to Most Transmission Pans
- Swivel Saddle Adjusts Both Directions
- Meets ANSI 2014 Standards
- Lowered Height: 8.5"
- Raised Height: 24.5"



24.5" REACH

OEM TOOLS

## Lift Tables

### 660 Lb. Double-Scissor Lifting Table Cart

SKU 1525568 **499<sup>99</sup>**  
24789

- Reduces Operator Strain When Moving Heavy or Bulky Items
- Double-Scissor Mechanism Raises the Table from 13.8" to 50.6"
- Large 32" x 20" Platform Fits a Wide Range of Items
- Foot Pedal Pump Allows Hands-Free Operation
- Hand Operated Release Lever for Easy, Controlled Descent
- 5" Heavy Duty Casters with Bearings for Easy Rolling Over Rough Floors
- Safety Bar Lock Mechanism Allows the Table to Be Secured at 40.2"
- All-Steel Construction for Strength and Durability



OEM TOOLS

### Heavy Duty Hydraulic Table Cart

SKU OSB **1,499<sup>99</sup>**  
AFF3904

- Total Capacity: 1,100 Lb.
- Positions and Raises Work Piece from 11" to 36"
- Extra Large 32" x 19.5" Work Area
- Foot Operated Pedal Keeps Your Hands Free
- Constructed with 2 Wheel Brakes for Added Safety
- Handle Mounted Pressure Release



For OSB, Call 901-300-4878

AFF

Prices subject to change without notice. Prices do not include applicable taxes, vehicles, tires, rims, installation or optional equipment as shown. Please do not return purchases to the store. For information regarding warranty, repair, or any questions or concerns, call 901-300-4878.

AZG0226

71

# JACKS & HYDRAULICS

## Engine Stands

### Heavy Duty 1,000 Lb. Engine Stand

SKU 757115 **229<sup>99</sup>**  
24839

- Adjustable Mounting Arms to Fit Most Engine Configurations
- Locking Head Plate with 360° Engine Rotation
- Tubular Steel Construction
- Base: 32-1/2" (L) x 30-3/4" (W)
- Height: 37-3/8"
- Weight: 41.9 Lb.



### 1,250 Lb. Engine Stand

SKU 462493 **299<sup>99</sup>**  
24829

- Easy to Move and Rotate
- Heavy Gauge Square Steel Tube Frame
- Extra Wide 4 Wheel Base Provides Added Stability
- 360° Rotation
- Lock Pin Locks Engine into Position



### 1 Ton Folding Engine Stand

SKU 544804 **399<sup>99</sup>**  
24834

- Folds Upright to Conserve Valuable Floor Space
- Sturdy, Wide-Base Design to Prevent Tipping Under Load



### 1,100 Lb. Rotating Engine Stand

SKU 1125862 **599<sup>99</sup>**  
24798

- Adjustable Mounting Arms to Fit Most Engine Configurations
- Locking Head Plate with 360° Engine Rotation
- Heavy Duty Worm Gear for Effortless Rotation
- Tubular Steel Construction
- Folding Legs for Easy Storage
- Base: 41-1/4" (L) x 27-1/8" (W)
- Weight: 102.5 Lb.



## Shop Cranes

### 2 Ton Folding Shop Crane

SKU 544801 **449<sup>99</sup>**  
24830

- Foldable Design Makes for Convenient, Easy Storage
- 6 Solid Steel Caster Wheels Add Mobility
- Fully Adjustable 4 Position Boom



### 2 Ton Folding Shop Crane

SKU 902288 **674<sup>99</sup>**  
RANRSC2TF

- Heavy Duty Hydraulic Folding Engine Hoist with 2 Ton Capacity Ram is Perfect for Shops That Have Limited Space but Still Need the Pure Lifting Convenience of a Crane
- Front Casters Include a Safety Brake to Prevent Movement



### 6,000 Lb. Heavy Duty Engine Crane

SKU 1267948 **1,579<sup>99</sup>**  
AFF3584

- Reinforced Leg Assemblies for Added Strength and Durability
- 4 Different Boom Settings: 3, 2, 1.5 and 1 Ton
- Rear of Crane: 61.5" Tall x 33" Wide
- Distance Between Front of Legs: Retracted 23", Extended 28.5"
- Built-In Safety Overload to Protect the Unit from Being Used Beyond its Rated Capacity



## Lifting Accessories

### Universal Engine Lift Plate

SKU 662861 **24<sup>99</sup>**  
24867

- Corrosion Resistant, Gold Iridite Zinc Plating
- Tough, All Steel Construction
- Fits Most Style 6 and 8 Cylinder Engines with 2 or 4 Barrel Intake Manifolds
- Mounting Hardware Not Included

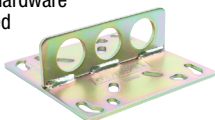

### Floor Jack Crossbeam

SKU 544803 **159<sup>99</sup>**  
24833

- Compatible with Most Floor Jacks with a 1-1/8" Diameter Saddle Stud
- Saddles Adjust from 23" to 32" on Center
- Min. Width Capacity: 3,000 Lb.
- Max. Width Capacity: 4,000 Lb.



### Fuel Tank Adapter

SKU 1407554 **219<sup>99</sup>**  
24832

- Makes Fuel Tank Removal Safe and Easy
- Works with Most Transmission Jacks
- Includes: 2 Nylon Straps to Secure Tank
- Foam Rubber Pads Protect Tank



### Bed Lifter

SKU OSB **369<sup>99</sup>**  
STK35885

- Designed to Lift Truck Beds Safely and Easily
- Lifting Brackets Adjusts to Evenly Distribute Weight

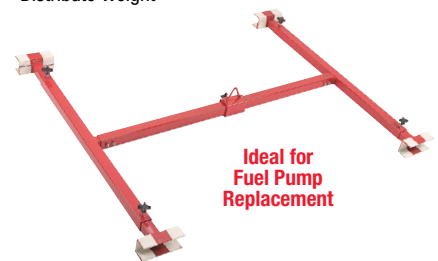

Ideal for Fuel Pump Replacement

For OSB, Call 901-300-4878

# JACKS & HYDRAULICS

TO ORDER, contact your Commercial Sales Manager or go to [AutoZonePro.com](http://AutoZonePro.com)

JACKS & HYDRAULICS

## Engine Support

### 3 Point Engine Support Bar

SKU 133617 **129<sup>99</sup>**  
24951

- Makes Removal of Transaxle Easy by Supporting Engine of Front Wheel Drive Vehicles
- Width Expands from 34-1/2" to 61"
- (2) 14" Adjustable Hook Screws
- (2) 38" Braided Steel Cables
- 700 Lb. Capacity



### 1,100 Lb. Engine Support

SKU 512946 **174<sup>99</sup>**  
24950

- 2 Screw Adjusters for Precise Positioning Makes Job Easier, Faster and Safer
- Rubber Feet to Prevent Damage to Vehicle and Ensure Stability
- 1,100 Lb. Capacity



### 3/4 Ton Engine Leveler

SKU 544802 **89<sup>99</sup>**  
24831

- 4 Point Mounting System Provides Maximum Control
- 3 Chain Positions to Accommodate Different Engine Configurations
- Durable Steel Construction
- Smooth Operating Worm Drive Shaft for Easy Level Adjustment
- Rated Capacity: 1,500 Lb.

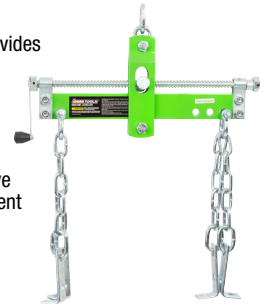

## High Reach Stands

- Provides Added Support During Installation/Removal of Automotive Components
- Compact Design for Use in Limited Workspaces
- Durable Heavy Gauge Steel Construction

### 1,500 Lb. High Reach Jack Stand

SKU 757043  
24848

**186<sup>99</sup>**

- Min. Height: 55"
- Max. Height: 78"
- Meets or Exceeds ASME PASE-2019 Standards



### 1,500 Lb. High Reach Jack Stand with Foot Pedal

SKU 757078 **219<sup>99</sup>**  
24847

- Foot Pedal Pump Saves Time Adjusting Load
- Min. Height: 55"
- Max. Height: 78"
- Meets or Exceeds ASME PASE-2019 Standards

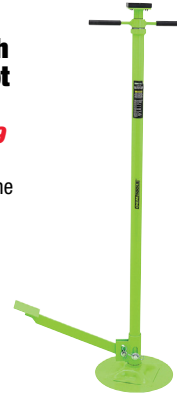

### 2 Ton Underhoist Tripod Jack Stand

SKU 757084 **199<sup>99</sup>**  
24849

- Adjustment Pin Securely Supports Load in 5 Positions
- Min. Height: 49"
- Max. Height: 80"
- Meets or Exceeds ASME PASE-2019 Standards



## Powertrain Lifts

### EV Lift Table

SKU OSB  
CHLBT3300 **13,309<sup>99</sup>**

- 3,300 Lb. Lift Capacity
- Scissor-Style Lifting
- Hydraulic Cylinder and 115V Plug
- Pendant Controlled Operation
- Max. Reachable Height: 76.5"
- Complies with ASME PASE-2019
- 8" Clearance Under Base Plate for Battery Removal
- Extending, Adjusting and Tilting Top Plate for Larger Batteries



Challenger Lifts

### 2,500 Lb. Powertrain Lift

SKU OSB  
AFF3182 **6,349<sup>99</sup>**

- Air Assist Foot Pump with 9' Extension Provides Hands-Free Operation
- Safety Latches at 30%, 50% and 80% of Max. Height
- 8" Diameter Swivel Casters for Easy Maneuverability
- Rear Wheels Can Be Locked to Prevent Rolling
- Table Top Height from 33" to 77"



### 4,500 Lb. BendPak EV Battery and Powertrain Lift Table

SKU OSB  
BENEVS4500

**11,179<sup>99</sup>**

- Full-Rise Battery Powered Mobile Scissor Lift Table
- Remote Control Operation
- DC Electric Power System with Onboard Charging
- Full-Length Utility Trays



### 2,200 Lb. Lifting Table, Air/Hydraulic with Adapters

SKU OSB  
CEA-MS10KIT **4,499<sup>99</sup>**

- Designed for Removing/Replacing Battery Packs of Electric Vehicles as well as the Engine, Transmission, Drive Axle, Fuel Tank, Suspension and Sub-Frames of Traditional Vehicles
- Large Base Frame Ensures Better Stability and Reliability
- Max. Lift: 70-1/16"
- Min. Height: 22-7/16"
- Platform Length: 51-3/8" to 58-1/4"
- Platform Width: 33-1/8"



CUTTING EDGE  
AUTOMOTIVE SOLUTIONS

### 2,640 Lb. Lifting Table, Electric/Hydraulic with Adapters

SKU OSB  
CEA-MS12MKIT **6,999<sup>99</sup>**

To Confirm Price, Availability and Ordering Instructions on OSB, Call 901-300-4878

Prices subject to change without notice. Prices do not include applicable taxes, vehicles, tires, rims, installation or optional equipment as shown. Please do not return purchases to the store. For information regarding warranty, repair, or any questions or concerns, call 901-300-4878.

AZG0226

73

# AIR COMPRESSORS

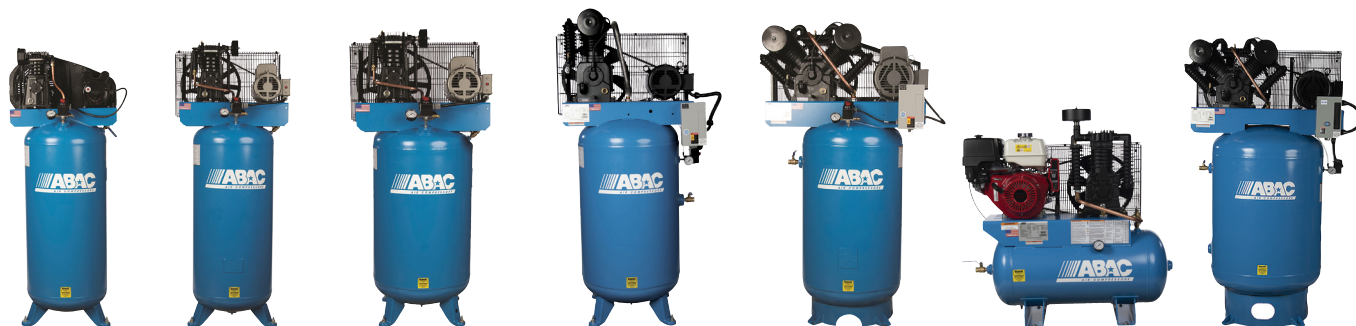

Description and Part Number	<b>3.5 HP 60 Gallon 230V Air Compressor, Single Phase</b> SKU OSB ABA3-2160V1	<b>5 HP 60 Gallon 230V Air Compressor, Single Phase</b> SKU OSB ABA5-2160V4	<b>5 HP 80 Gallon 230V Air Compressor, Single Phase</b> SKU OSB ABA5-2180V4NS	<b>5 HP 80 Gallon 230V Air Compressor</b> SKU OSB ABAC5-2180V - Single Phase ABAC5-2380V - 3 Phase	<b>7.5 HP 80 Gallon 230V Air Compressor</b> SKU OSB ABAC7-2180V2 - Single Phase ABAC7-2380V2 - 3 Phase	<b>13 HP 30 Gallon Honda Powered Air Compressor</b> SKU OSB ABA13-30GH  <b>CARB Compliant</b>	<b>10 HP 120 Gallon 230V Air Compressor, 3 Phase</b> SKU OSB ABAC10-23120V
CFM at 100 psi	12.3 CFM (1 Technician)	15.4 CFM (1-2 Technicians)	15.4 CFM (1-3 Technicians)	18 CFM (2-3 Technicians)	27 CFM (3-5 Technicians)	23 CFM (1-3 Technicians)	35 CFM (4-6 Technicians)
Max. Pressure	135 psi	175 psi	175 psi	175 psi	175 psi	175 psi	175 psi
Heavy Duty, Low-RPM Cast Iron Pump	Cast Iron Cylinders	Cast Iron Cylinders	Cast Iron Cylinders	Yes	Yes	Cast Iron Cylinders	Yes
Magnetic Starter Mounted and Wired	Not Required	Not Required	Not Required	Yes	Yes	Recoil and Electric Start	Yes
High Flow Belt Guard	Yes	Yes	Yes	Yes	Yes	Yes	Yes
Warranty	1 Year	2 Years	2 Years	2 Years	2 Years	2 Years	2 Years
<b>Price</b>	<b>1,219<sup>99</sup></b>	<b>1,599<sup>99</sup></b>	<b>1,969<sup>99</sup></b>	<b>2,799<sup>99</sup></b>	<b>3,569<sup>99</sup></b>	<b>3,379<sup>99</sup></b>	<b>4,899<sup>99</sup></b>

## Premium Models

**10 HP 120 Gallon 230V**  
SKU OSB  
ABAC10-23120VFF **5,499<sup>99</sup>**

- Vertical 120 Gallon Tank
- Horsepower: 10 HP
- Power Supply (V/Ph): 230V/3
- CFM @ Max. psi: 32
- Max. psi: 176

**7.5 HP 80 Gallon 230V**  
SKU OSB  
ABAC7-2180V2FF **4,259<sup>99</sup>**

- Power Supply (V/Ph): 230V/1
- CFM @ Max. psi: 24



Premium Models Include: Low Oil Level Shut Off, Auto Tank Drain and Belt Guard Aftercooler

## Refrigerated Dryers

- Removes Condensate and Vapor so Dry Compressed Air is Produced in a Continuous, Cost-Efficient Way
- 115 VAC

**Cool 15 CFM**  
SKU OSB  
ABAC00L15 **899<sup>99</sup>**

**Cool 25 CFM**  
SKU OSB  
ABAC00L25 **1,099<sup>99</sup>**

**Cool 35 CFM**  
SKU OSB  
ABAC00L35 **1,299<sup>99</sup>**



ABAC00L15



Customer Responsible For Offloading, Liftgate Service Available.

For OSB, Call 901-300-4878

- Free Delivery in 48 Continental United States
- Specifications Subject to Change without Notice or Liability
- Equipment Lead Times and Shipping May Vary
- Customers Responsible for Offloading Equipment Upon Arrival
- Leasing Terms Available, Ask Your AutoZone® Commercial Sales Manager.

# AIR COMPRESSORS

FOR HELP with Selection, Confirm Availability and Ordering Instructions, Call 901-300-4878

AIR COMPRESSORS

## Atlas Compressors

### 13 HP 30 Gallon Gas Air Compressor Honda Powered

- SKU **OSB**  
**ATLMPAF13G-FPD** **3,949<sup>99</sup>**
- 13HP, Honda GX390 Engine
  - Air Output: 145-175 psi
  - CFM@175; psi: 19
  - Vibro-Isolation Pads to Reduce Vibration



CARB Compliant

### 10 HP Single Phase 120 Gallon Air Compressor

- SKU **OSB**  
**ATLMPAF101PHFPD** **6,299<sup>99</sup>**
- Plus Package Includes: Aftercooler, Low Oil Shutoff and Auto-Tank Drain
  - CFM@175 psi: 35
  - Air Output: 145-175 psi
  - Compressor Oil Drain Extension Tube, Heavy Duty Metal Belt Guard
  - Vibro-Isolation Pads to Reduce Vibration
  - Electric: 220 Volt/1 Phase

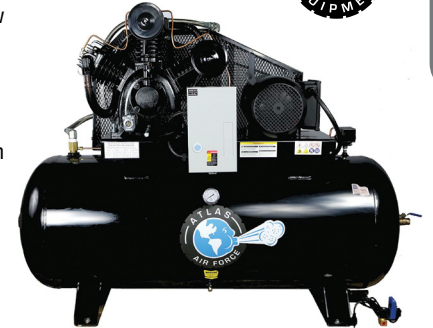

### 5 HP 60 Gallon Vertical Air Compressor

- SKU **OSB**  
**ATLMPAF5-FPD** **1,899<sup>99</sup>**
- Air Output: 90-125 psi
  - CFM@90 psi: 18.0
  - Compressor Oil Drain Extension Tube
  - Vibro-Isolation Pads to Reduce Vibration
  - Electric: 220 Volt/1 Phase



### 5 HP 80 Gallon Air Compressor

- SKU **OSB**  
**ATLMPAF8-FPD** **3,149<sup>99</sup>**
- Air Output: 145-175 psi
  - CFM@175 psi: 19
  - Includes: Magnetic Starter
  - Compressor Oil Drain Extension Tube
  - Vibro-Isolation Pads to Reduce Vibration
  - Electric: 220 Volt/1 Phase



ATLMPAF8-FPD

### 5 HP 80 Gallon Vertical Air Compressor

- SKU **OSB**  
**ATLMPAF6-FPD** **2,349<sup>99</sup>**
- Air Output: 90-175 psi
  - CFM@175 psi: 14.5
  - Compressor Oil Drain Extension Tube
  - Vibro-Isolation Pads to Reduce Vibration
  - Electric: 220 Volt/1 Phase



### 7.5 HP 80 Gallon Air Compressor

- SKU **OSB**  
**ATLMPAF9-FPD** **3,649<sup>99</sup>**
- Air Output: 145 to 175 psi
  - CFM@175 psi: 20
  - Includes: Magnetic Starter
  - Hands-Free Tank and Oil Drain Extensions for Easy Maintenance
  - Vibro-Isolation Pads to Reduce Vibration
  - Electric: 220 Volt/1 Phase

For a Wider Selection  
Go to [AZTool1.com](http://AZTool1.com)

## Rotary Screw Compressors

- High Performance with Low Energy Consumption
- Low Noise and Vibration Levels
- Fully Integrated Aluminum Block

### 10 HP 131 Gallon 150 psi Screw Compressor with Dryer

- SKU **OSB**  
**ABAAS-10503TMD** **8,749<sup>99</sup>**
- 208V-230V-460V/3PH
  - 34.1 CFM

### 15 HP 131 Gallon 150 psi Screw Compressor with Dryer

- SKU **OSB**  
**ABAAS-15503TMD** **11,899<sup>99</sup>**
- 208V-230V-460V/3PH
  - 46.4 CFM

### 7.5 HP 131 Gallon 150 psi Screw Compressor

- SKU **OSB**  
**ABAAS-75501TM** **7,049<sup>99</sup>**
- 230V/1PH
  - 27.1 CFM



ABAAS-10503TMD

## Mi-T-M

### 30 Gallon Air Compressor/Generator

- SKU **OSB**  
**MTMAG2SM1430ME** **3,499<sup>99</sup>**

- CFM @ 175 psi 15.7
- Max. AC Output: 4000 Watts
- Continuous with Compressor On Load 2300 Watts
- Continuous with Compressor Off Load 3500 Watts
- Receptacles 2 NEMA 5-20R, 1 NEMA L6-20R
- Displacement/Engine 420cc Mi-T-M OHV
- Compressor Two Stage, Cast Iron Pump



CARB Compliant



Customer Responsible For Offloading, Liftgate Service Available.

For OSB, Call 901-300-4878

- Free Delivery in 48 Continental United States
- Specifications Subject to Change without Notice or Liability
- Equipment Lead Times and Shipping May Vary
- Customers Responsible for Offloading Equipment Upon Arrival
- Leasing Terms Available, Ask Your AutoZone® Commercial Sales Manager.

Prices subject to change without notice. Prices do not include applicable taxes, vehicles, tires, rims, installation or optional equipment as shown. Please do not return purchases to the store. For information regarding warranty, repair, or any questions or concerns, call 901-300-4878.

AZG0226

75

# AIR TOOLS

## 1/2" Impact Wrenches

### Heavy Duty 1/2" Composite Stubby Impact Wrench

SKU 087596 24418 **209<sup>99</sup>**

- Torque: 900 Ft/Lb.
- Includes: (7) 1/2" Short Impact Sockets Sizes 13 mm to 19 mm
- Custom Cut EVA Foam Storage Tray
- CFM: 4.0



WARRANTY: 1 Year

### 1/2" Impact Wrench

SKU 970487 IRT231HA **239<sup>99</sup>**

- Torque: 590 Ft/Lb.
- Pressure-Fed Lubrication System
- In-Handle Exhaust Directs Air Away from User
- Industry Standard for 3 Decades
- Sound Pressure: 94 to 105 dBA



WARRANTY: 1 Year

### 1/2" Super Duty Air Impact Wrench with Extended Anvil

SKU 604744 IRT231HA2 **264<sup>99</sup>**

- Max. Torque: 590 Ft/Lb.
- In-Handle Exhaust Directs Air Away from User
- Pressure-Fed Lubrication System



WARRANTY: 1 Year

### 1/2" Air Impact Wrench Classic

SKU 495316 IRT231C **199<sup>99</sup>**

- Original Twin Hammer Impact
- Torque: 600 Ft/Lb.
- Pressure-Fed Lubrication
- Adjustable Power Regulator
- 1/2" Square Drive



WARRANTY: 1 Year

### 1/2" Quiet Impact Wrench

SKU 738489 IRT2135QXPA **379<sup>99</sup>**

- Torque: 780 Ft/Lb.
- Light, Quiet and Powerful Impact
- Twin Hammer Mechanism
- Weighs Only 4 Lb.



WARRANTY: 1 Year

### 1/2" Titanium Air Impact Wrench

SKU 695134 IRT2235TIMAX **564<sup>99</sup>**

- Torque: 1,350 Ft/Lb.
- Reverse Torque: 930 Ft/Lb.
- Twin Hammer Impact Mechanism
- Lightweight



WARRANTY: 2 Years

### 1/2" Titanium Air Impact Wrench with Extended Anvil

SKU OSB IRT2235TIMAX2 **549<sup>99</sup>**

- Torque: 1,350 Ft/Lb.
- Max. Reverse Torque: 930 Lb.
- 8,500 Free Speed RPM
- Titanium Hammercase



For OSB, Call 901-300-4878

WARRANTY: 2 Years

### 1/2" Nitrocat Composite Twin Clutch Impact Wrench

SKU 1580951 ACA1250K **419<sup>99</sup>**

- Provides 950 Ft/Lb. Max. Torque and 1,300 Ft/Lb. of Loosening Torque
- Hard Hitting Smooth Twin Clutch Mechanism
- The Twin Clutch is Better Suited for Heavy Duty
- Weight: 4.5 Lb.



WARRANTY: 2 Years

### 1/2" Compact Impact Wrench

SKU 1580967 ACA1057-TH **219<sup>99</sup>**

- Provides 500 Ft/Lb. Max. Torque and 700 Ft/Lb. of Loosening Torque
- Low Weight Aluminum Alloy Housing
- Weight: 2.80 Lb.
- Length: 3.85"
- Air Inlet: NPT 1/4"



WARRANTY: 2 Years

### 1/2" Composite Impact Wrench

SKU OSB ACA1150 **249<sup>99</sup>**

- Provides 900 Ft/Lb. Max. Torque and 1,295 Ft/Lb. of Loosening Torque
- Durable Composite Housing
- Weight: 4.5 Lb.
- Length: 7.5"
- Free Speed: 9,000 RPM



For OSB, Call 901-300-4878

WARRANTY: 2 Years

### 1/2" Impact Wrench

SKU 1580946 ACA1431 **179<sup>99</sup>**

- Provides 800 Ft/Lb. Max. Torque and 1,000 Ft/Lb. of Loosening Torque
- Cross Bolt Forward/Reverse and Power Management Control
- Weight: 5.7 Lb.
- Length: 7.2"
- Free Speed: 9,000 RPM



WARRANTY: 2 Years

### 1/2" Composite Impact Wrench

SKU 1580952 ACA1000TH **309<sup>99</sup>**

- Provides 800 Ft/Lb. Max. Torque and 1,000 Ft/Lb. of Loosening Torque
- Patented Quiet Tuned Exhaust (86 dBA)
- Air Cons.: (CFM) 8
- Weight: 4.5 Lb.
- Length: 7.5"



WARRANTY: 2 Years

### 1/2" Vibrotherm Drive Composite Impact Wrench

SKU 1580965 ACA1178-VXL **384<sup>99</sup>**

- Provides 950 Ft/Lb. Max. Torque and 1,300 Ft/Lb. of Loosening Torque
- Weight: 4.5 Lb.
- Free Speed: 7,500 RPM
- Air Inlet: NPT 1/4"



WARRANTY: 3 Years

## 3/8" Impact Wrench



### 3/8" Titanium Impact Wrench

SKU 198065  
IRT2115TIMAX  
**329<sup>99</sup>**

- Torque: 300 Ft/Lb.
- Feather Touch Trigger and Patented Push Button Forward/Reverse



WARRANTY: 2 Years

## 3/4" Impact Wrench



### 3/4" Composite Impact Wrench

SKU 1580960  
ACA1778-VXL  
**719<sup>99</sup>**

- Provides 1,450 Ft/Lb. Max. Torque and 1,700 Ft/Lb. of Loosening Torque
- The Latest Patented Aircat Muffler System Provides the Aircat's Unmatched Low Noise Levels
- Weight: 7.7 Lb.
- Length: 7.7"
- Free Speed: 5,400 RPM



WARRANTY: 3 Years

## Don't Forget Your Air Hose Couplers

70%  
MORE  
FLOW



See Page 75

## Air Ratchets



### 3/8" Air Ratchet

SKU 970485  
IRTIR107XPA  
**184<sup>99</sup>**

- Max. Torque: 54 Ft/Lb.
- Advanced Head Design
- 360° Adjustable Exhaust



WARRANTY: 1 Year

### 1/4" Super Duty Air Impact Ratchet

SKU 850508  
24415  
**49<sup>99</sup>**

Impact Mechanism Adds Power and Prevents Kickback

- Max. Torque: 50 Ft/Lb.
- Free Speed: 700 RPM
- CFM: 3.1 @ 90 psi
- Length: 6.5"
- Sealed Head Ratchet Housing Prolongs Tool Life
- Compact and Lightweight
- Most Power-to-Weight Ratio
- Rear Air Exhaust: 360° Adjustable

WARRANTY: 1 Year



Composite  
Body

### 3/8" Dr. Air Ratchet Wrench



SKU 662908  
KNGNE-343  
**144<sup>99</sup>**

- 3/8" Dr. with 75 Ft/Lb. of Max. Reverse Torque
- Forward Working Torque: 10-55 Ft/Lb.
- Free Speed: 160 RPM



WARRANTY: 3 Years

## Air Hammers

### Standard Duty Air Hammer

SKU 1392327  
IRT117  
**109<sup>99</sup>**

- 2,000 Blows per Minute
- Heat-Treated Piston and an Alloyed Steel Barrel



WARRANTY: 1 Year

### 121Q Super Duty Air Hammer

SKU 478945  
IRT121Q  
**164<sup>99</sup>**

- Ideal for Body Panel Crimping and Cutting, Bushing Driving, Shearing and General Front End Work
- Built-In Power Regulator and Trigger Control
- Easy to Control with an "Easy Out" Throttle



WARRANTY: 1 Year

## Cut-Off Tools



### 3" Air Cut-Off Tool

SKU 466590  
25760  
**52<sup>99</sup>**

- Air Inlet Thread Size: 1/4" NPT
- Free Speed: 22,000 RPM
- Recommended Air Pressure: 90 psi



WARRANTY: 1 Year

## Air Drill



### 3/8" Capacity Keyless Composite Pistol Grip Drill

SKU 1580948  
ACA4338  
**279<sup>99</sup>**

- Air Consumption: (CFM) 6
- 1,800 RPM
- Reversible and Variable Speed
- Length: 7"



WARRANTY: 2 Years

## Inflators



### Digital Tire Inflator

SKU 802198  
24412  
**99<sup>99</sup>**

- Easy-to-Read Backlit LCD Display
- 4 Units of Measure (psi, Bar, KPa, kgf)
- Measuring Range: 0 to 175 psi (0 - 12 Bar)
- Accuracy: +/-1.2 psi Up to 58 psi, +/-2.3 Between 58 psi and 145 psi Inclusive, +/-3.6 psi Greater Than 145 psi
- High Air Flow Saves the Technician Time



### Dial Tire Inflator

SKU 301772  
24380  
**84<sup>99</sup>**

- Clear and Easy-to-Read 80 mm 180 psi Gauge
- 3-In-1 Function: Inflate, Deflate and Measure Tire Pressure
- Increased Accuracy to Improve Tire Performance and Prevent TPMS Comebacks



### 3.5" Digital Tire Inflator with Hose

SKU 1268419  
AST3018  
**114<sup>99</sup>**

- 21" Stainless Braided Hose
- Dual AAA Battery Powered Design
- Backlit LCD Digital Read-Out
- Includes Batteries



### Dual Head Chuck Tire Inflator Gauge

SKU 094652  
25864  
**44<sup>99</sup>**

- 6" Chrome Plated Dual-Head Chuck with Full 360° Swivel Action
- 15" Air Hose with 1/4" Female NPT and 3/8" 24 Thread Air Intake
- Inflates within 10 to 120 Lb. Pressure Range
- Magnifying Bubble Lens, Allows Full View of the Pressure Scale
- Gauge in 2 Lb. Increments



# AIR TOOLS

## Surface Prep

### Heavy Duty Mini Surface Prep Kit

SKU 087620 **79<sup>99</sup>** REG. \$174.99  
24417

- 2" and 3" Heavy Duty Mini Air Surface Prep Sander
- (1) 2" Backer Pad
- (1) 3" Backer Pad
- (2) 2" and (2) 3" Medium Grit Surface Prep Discs
- (2) 2" and (2) 3" Coarse Surface Prep Discs
- (2) 2" and (2) 3" Sander Discs
- Blow Mold Case

**SAVE \$95**



WARRANTY: 1 Year

Offer Good Through June 30, 2026

### 1/4" Mini Angle Die Grinder and Surface Prep Kit

SKU 94648 **109<sup>99</sup>**  
25777

- Air Consumption: 4 CFM
- Free Speed: 20,000 RPM
- Grinding and Cleaning All-in-One Kit
- Comes in a Heavy Duty Plastic Tray



WARRANTY: 1 Year

## Air Sanders

### 2" Surface Prep Air Sander

SKU 094650 **79<sup>99</sup>**  
25778

- Includes Quick Change "Twist Lock" Mandrel
- Free Speed: 20,000 RPM
- Average Air Consumption: 3.2 CFM
- Air Inlet Thread Size: 1/4" NPT



WARRANTY: 1 Year

### Heavy Duty Reciprocating Air Saw

SKU 802225 **74<sup>99</sup>** REG. \$144.99  
24409

- Recommended Air Pressure: 90 psi
- Air Consumption: 1.7 CFM
- Strokes per Minute: 9,000 SPM
- Air Inlet Thread Size: 1/4" NPT
- Lightweight: 1.50 Lb. (0.70 kg)
- Length: 10.6" (270 mm)
- Exhaust: Front
- Enhanced Blade Guard Design and Trigger Safety Lock
- Includes: Reciprocating Air Saw, 2 Hex Key Wrenches, 2 Saw Blades and 2 Blade Guards

**SAVE \$70**



WARRANTY: 1 Year

Offer Good Through June 30, 2026

### 6" Dual Action Sander

SKU 970475 **94<sup>99</sup>**  
IRTIR311A

- Dual Action Pad Motion Reduces Swirl
- Built-In Silencer for Quiet Operation



WARRANTY: 1 Year

### Straight Line Sander

SKU 970479 **169<sup>99</sup>**  
IRTIR315

- Twin Piston Design for Smooth Operation
- 3,000 Strokes per Minute
- Quick-Action Paper Clamps



WARRANTY: 1 Year

## 1/4" Die Grinders

Composite Body with Built-In Silencing to Reduce Noise Level

### Mini Air Die Grinder

SKU 751631 **59<sup>99</sup>**  
24404

- Air Consumption: 2.4 CFM
- Free Speed: 25,000 RPM
- Recommended Air Pressure: 90 psi



WARRANTY: 1 Year

### 1/4" Air Die Grinder

SKU 802212 **54<sup>99</sup>**  
24406

- Air Consumption: 3.4 CFM
- Free Speed: 22,000 RPM
- Recommended Air Pressure: 90 psi
- Exhaust: Rear 360°



WARRANTY: 1 Year

### Mini Angle Air Die Grinder

SKU 802214 **79<sup>99</sup>**  
24407

- Air Consumption: 2.8 CFM
- Free Speed: 18,000 RPM
- Recommended Air Pressure: 90 psi
- Built-in Silencing to Reduce Noise Level



WARRANTY: 1 Year

### Extended Air Die Grinder

SKU 802216 **99<sup>99</sup>**  
24408

- Air Consumption: 2.5 CFM
- Free Speed: 23,000 RPM
- Recommended Air Pressure: 90 psi



(Color May Vary)

WARRANTY: 1 Year

### Mini Air Die Grinder

SKU 802211 **44<sup>99</sup>** REG. \$59.99  
24405

- Air Consumption: 3.4 CFM
- Free Speed: 25,000 RPM
- Recommended Air Pressure: 90 psi



**SAVE \$15**

WARRANTY: 1 Year

Offer Good Through June 30, 2026

# AIR TOOL ACCESSORIES

TO ORDER, contact your Commercial Sales Manager or go to [AutoZonePro.com](http://AutoZonePro.com)

AIR TOOL ACCESSORIES

## Impact Sockets and Extensions

### 1/2" Drive Impact Extension Set

SKU 1340235 **99<sup>99</sup>**  
SUN2500

- Set Includes: 1/2" Dr. 3", 5", 10" and 15" Impact Extensions
- Comes in a Blow Mold Case



### 3/8" Impact Sockets

- 6 Pt. High Quality Impact Sockets
- SAE: 5/16", 3/8", 7/16", 1/2", 9/16", 5/8", 11/16", 3/4", 13/16", 7/8", 15/16" and 1"
- Metric: 8, 9, 10, 11, 12, 13, 14, 15, 16, 17, 18 and 19 mm

**OEM TOOLS**

**Posi-Grip No Slip™ Design Provides Superior Gripping Power for Maximum Torque**  
**Chrome Moly Steel Construction for Strength and Durability**

### 12 Piece Shallow (SAE)

SKU 391191  
25589  
**26<sup>99</sup>**

### 12 Piece Shallow (Metric)

SKU 391190  
25587  
**26<sup>99</sup>**



### 12 Piece Deep (SAE)

SKU 442193  
25590  
**49<sup>99</sup>**

### 12 Piece Deep (Metric)

SKU 464314  
25588  
**44<sup>99</sup>**



### 5 Piece Budd Wheel Socket Set

SKU 1207878 **179<sup>99</sup>**  
37384

- 35 mm, 38 mm, 41 mm and 1-1/2" Sockets Feature a Dual Socket Design with a Hex to Remove the Lug Nut and an Internal Square Drive to Remove the Inside Wheel
- 38 mm, 41 mm and 1-1/2" Sockets Each Have a 13/16" Internal Square
- 35 mm Socket Has a 11/16" Internal Square
- Can Be Used with 1" Drive Ratchet, Breaker Bar, Torque Wrench and Impact Wrench



### 33 mm 1" Drive

SKU 466569 **30<sup>99</sup>**  
25528

- 1" Drive 33 mm Budd Wheel Socket for Mack, Midliner, Volvo, White and Other Import Trucks with Dual Rear Wheels

### 1-1/2" Hex x 13/16" Square Deep 1" Drive

SKU 466570 **25<sup>99</sup>**  
25529

- For Budd Wheel 1-1/2" Hex with 13/16" Inside Square

### 1/2" Impact Sockets

- 6 Pt. High Quality Impact Sockets
- SAE: 3/8", 7/16", 1/2", 9/16", 5/8", 11/16", 3/4", 13/16", 7/8", 15/16" and 1"
- Metric: 10, 11, 12, 13, 14, 15, 16, 17, 18 and 19 mm

**OEM TOOLS**

### 11 Piece Shallow (SAE)

SKU 391195  
25593  
**41<sup>99</sup>**

### 10 Piece Shallow (Metric)

SKU 391192  
25591  
**29<sup>99</sup>**



### 11 Piece Deep (SAE)

SKU 391196  
25594  
**51<sup>99</sup>**

### 10 Piece Deep (Metric)

SKU 391194  
25592  
**36<sup>99</sup>**



## Impact Adapters

**OEM TOOLS**

### 5 Piece Adapter and Universal Joint Set (3/8" and 1/2")

SKU 965864 **29<sup>99</sup>**  
24226

- Chrome Moly Steel Construction
- Includes: 3/8" Drive Universal Joint, 3/8" Drive (F) x 1/2" (M) Adapter, 1/2" Drive Universal Joint, 1/2" Drive (F) x 3/8" (M) Adapter and 1/2" Drive (F) x 3/4" (M) Adapter



## Air Blow Gun

**OEM TOOLS**

### 5 Piece Interchangeable Tip Air Blow Gun

SKU 338823 **23<sup>99</sup>**  
24439

- Includes 4 Interchangeable Tips: 100 mm (4"), 140 mm (5.5"), 320 mm (12.5") and a Turbo Wide Angle Nozzle
- Quick Change Coupling Makes it Easy to Change Tips
- Wide Angle Nozzle for High Volume
- Variable Trigger for Control Volume and Tip Pressure
- 1/4" NPT Air Inlet



## High Flow Couplers

### High Flow Coupler and Plug Kits

**70% MORE FLOW\***

- Ideal for HVLP Spray Guns and High Torque Impact Wrenches
- Delivers the Highest Air Volume with the Lowest Pressure Drop

### 14 Piece 1/4" Body, 1/4" NPT

SKU 757091 **26<sup>99</sup>**  
26134



### 7 Piece 1/4" Body, 1/4" NPT

SKU 757040 **14<sup>99</sup>**  
26132



### 7 Piece 1/4" Body, 3/8" NPT

SKU 757046 **23<sup>99</sup>**  
26133



\*When Paired Together, OEMTOOLS High Flow Couplers and Plugs Deliver Up to 70% More Flow than Conventional Couplers

Prices subject to change without notice. Prices do not include applicable taxes, vehicles, tires, rims, installation or optional equipment as shown. Please do not return purchases to the store. For information regarding warranty, repair, or any questions or concerns, call 901-300-4878.

AZG0226

# AIR TOOL ACCESSORIES

## Surface Prep

### Superior Quality Surface Prep Tools



Try our long lasting surface prep disks that save you time and money.

#### Surface Prep Discs (25 Pack)

• Twist-Lock Style

##### 2" Coarse

SKU 1330684  
22517 **19<sup>99</sup>**  
(0.79 each)



##### 3" Coarse

SKU 1335795  
22518 **16<sup>99</sup>**  
(0.68 each)



##### 2" Medium

SKU 1335806  
22516 **7<sup>99</sup>**  
(0.32 each)

##### 3" Medium

SKU 1335787  
22519 **16<sup>99</sup>**  
(0.68 each)



Tool Not Included

#### 2" Twist-to-Lock Surface Prep Discs (50 Pack) with Cookie Jar



##### Coarse

SKU 1146029  
SHA13088 **84<sup>99</sup>**

##### Assorted

SKU 1168677  
SHA13087 **89<sup>99</sup>**

• Includes: Coarse, Medium and Fine



#### 2" Purple Strip Disc with Twist-Lock (5 Pack)



SKU 298097  
SHA16206 **36<sup>99</sup>**

• Long-Life Silicon Carbide for Paint and Coating Removal

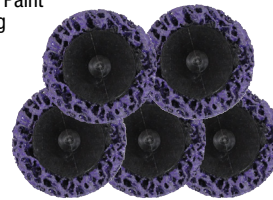

#### 2" Twist-Lock Mini Flap Discs Assorted Grits (6 Pack)



SKU 306275  
SHA13056 **44<sup>99</sup>**

• Outlasts Mini Grinding Discs by 3 Times  
• Includes: 2 Each of 40, 60 and 80 Grit



#### Twist-Lock Disc Holders

SKU 1368617  
SHA13012 **17<sup>99</sup>**

• 2" Holder (Single)



SKU 094911  
SHA323T2 **29<sup>99</sup>**

• 2" Holder (2 Pack)



#### Twist-to-Lock Green Zirconia Mini Grinding Discs

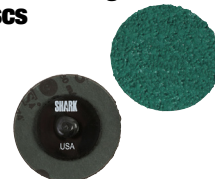

#### Green Zirconia



SKU	Part #	Size	Grit	Qty	Price
306282	SHA12613	2"	36	25	<b>44.99</b>
305896	SHA12614	2"	50	25	<b>44.99</b>
204022	SHA12615	2"	80	25	<b>44.99</b>
305827	SHA12618	3"	50	25	<b>54.99</b>
204009	SHA12619	3"	80	25	<b>54.99</b>

## Cut-Off Accessories



#### Mandrel Set for Cut-Off Tools (2 Pack)

SKU 094907  
SHA32 **29<sup>99</sup>**



#### 10 Piece Cut-Off Wheel Set with Mandrel

SKU 1400046  
26528 **19<sup>99</sup>**

• Capable of Cutting Fiberglass, Plastic, Iron, Steel and Other Ferrous Metals  
• Quantity: (10) 3" x 1/16" Cut-Off Wheels with 3/8" Arbor, 46 Grit  
• Max. RPM: 20,400



#### 3" Aluminum Cutting Wheels (10 Pack)

SKU 306331  
SHA13178PK2 **55<sup>99</sup>**

• Silicon Carbide Grain  
• Includes: (10) 3" x 1/16" x 3/8" Cut-Off Wheels  
• Works on 3" Die Grinders



#### 3" x 1/16" x 3/8" Reinforced Cut-Off Wheels (25 Pack)

SKU 306273  
SHA25E5PK5 **74<sup>99</sup>**

• For Use with Pneumatic Cut-Off Tools  
• Max. RPM: 25,000  
• Includes: 25 Discs



## Air Piping



#### MaxLine Compressed Air Piping System 3/4" Master Kit

SKU 360593  
RAPM7500 **399<sup>99</sup>**

**Aluminum Core: Holds Any Bent Shape!**

• Heavier Duty Components for Longer Air Runs in Larger Buildings  
• 3 Air Outlets, (1) 3/4" NPT Straight Fitting, 2 Tees, 20 Clips and 100' of 3/4" HDPE Tubing



#### 1/2" Tubing Master Kit

SKU 360485  
RAP90500 **269<sup>99</sup>**

See More RapidAir® Products on AutoZonePro.com

Prices subject to change without notice. Prices do not include applicable taxes, vehicles, tires, rims, installation or optional equipment as shown. Please do not return purchases to the store. For information regarding warranty, repair, or any questions or concerns, call 901-300-4878.

# AIR TOOL ACCESSORIES

TO ORDER, contact your Commercial Sales Manager or go to [AutoZonePro.com](http://AutoZonePro.com)

AIR TOOL ACCESSORIES

## Regulators/Filters/Drains

### 5 Stage Desiccant Filter/Dryer

SKU 543076 **549<sup>99</sup>**  
ARRC7612XL

- Includes: Gauge, Shut-Off Valve and (1) 1/2 Gallon of Desiccant
- Lowers the Dew Point to -30°F



### Filter/Regulator (1/2")

SKU 543071 **109<sup>99</sup>**  
ARRB754G

- Operating Pressure Range 5 to 125 psi
- 40 Micron Element
- 3 Position Non-Rising Adjustment Knob



### Filter Regulator Lubricator (1/2")

SKU 543075 **279<sup>99</sup>**  
ARRC33354

- Cleans, Dries and Lubricates Air Supply
- Operating Pressure Range: 5 to 125 psi
- 40 Micron Element
- 142 CFM



Extend the Life of Your Air Tools!



### 1/2" Electronic Drain

SKU 543065 **99<sup>99</sup>**  
ARR5804

- Automatically Drains Compressor Tanks, Receiver Tanks or Filters
- 110 Volt
- 6' Power Cord



### Regulator with Gauge (1/4")

SKU 543086 **49<sup>99</sup>**  
ARRR262G

- Adjustment Range is 5 to 125 psig
- Rated for 25 SCFM



### Air Regulator with Gauge (1/2")

SKU 543091 **79<sup>99</sup>**  
ARRR354G

- Adjustment Range is 5 to 125 psig
- Rated for 100 SCFM



NAME	SKU	PART #	PRICE
Regulator with Gauge (3/8")	543088	ARRR353G	<b>79.99</b>

## Hoses and Hose Reels

### 50' Nitrile Rubber Hose 3/8"

- Lays Flat Under Pressure for Easy Maneuverability and Safety
- Meets PFAS-Free Regulations
- Resists Abrasions and Kinks
- UV Protective Material
- Excellent Resistance to Grease, Oil and Weather

SKU 1491310 **64<sup>99</sup>**  
LIN72N3850

- 1/4" NPT Brass Fittings



### 1/2"

SKU 1491309 **89<sup>99</sup>**  
LIN72N1250

- 1/2" NPT Brass Fittings

### 50' Premium Hybrid Hose

- Lightweight Design for Ease of Use and Enhanced Portability
- Kink Resistant with All-Weather Flexibility (-40° to 150°F)

SKU 1491308 **59<sup>99</sup>**  
LIN72H3850

- 1/4" NPT Brass Fittings

SKU 1491307 **89<sup>99</sup>**  
LIN72H1250

- 1/2" NPT Brass Fittings



### 100' Wall Mount Air Hose Reel

SKU 291343 **42<sup>99</sup>**  
25970

- Comes with 18" Leader Hose
- Mounts Solid or with Swivel Action
- Solid Steel Frame
- Some Assembly Required



### 3/8" x 50' Air Hose Reel

SKU 900815 **179<sup>99</sup>**  
25979

- Smooth Automatic Retracting Spring Coil
- 50' Hose
- 3/8" NPT Fittings
- Max. Pressure: 250 psi

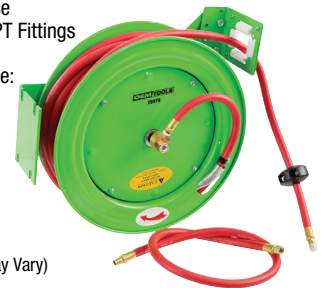

(Color May Vary)

### 3/8" x 50' Hybrid Polymer Air Hose with Reel

SKU 347224 **124<sup>99</sup>**  
24424 REG. \$199.99

**SAVE \$75**

- Heavy Duty Polymer Hose Material Redefines Flexibility - Stays Flexible Under All Weather Conditions (-40° to 150°F)
- Holds No Memory - Kink Resistant Under Pressure
- 300 psi Working Pressure
- Bend Restriction for Reducing Wear and Tear and Extending Life of Hose
- Solid Brass MNPT Ends



Offer Good Through June 30, 2026

### Value Series Air Hose Reel

- Retractable Delivery Hose
- Durable Heavy Gauge Steel Construction
- Slotted Mounting Base for Easy Installation

3/8" x 50'  
SKU 972284 **299<sup>99</sup>**  
LIN83753

1/2" x 50'  
SKU 972285 **319<sup>99</sup>**  
LIN83754



### 3/8" x 50' Retractable Air Hose Reel

SKU OSB **199<sup>99</sup>**  
LEGL8250FZ

- Extreme All-Weather Flexibility, Even in Subzero Temperatures (-40° to 140°F)
- Won't Kink Under Pressure



For OSB, Call 901-300-4878



## Air Chuck

### Dual Foot Air Chuck with Comfort Grip Handle

SKU 802201 **28<sup>99</sup>**  
24413

- Comfortable Screwdriver Style Handle
- 30° Reverse Angle Chuck Can Be Used on Outside Tires
- Tilt Lock Feature Locks onto the Valve



### Air Chuck with Comfort Grip Handle

SKU 802200 **19<sup>99</sup>**  
24414

- Durable, OEMTOOLS Screwdriver Style Handle for Comfort and a Positive Grip
- Sealed-Ball Air Chuck is Extended 1" from Handle to Allow Access to Tight Areas



Prices subject to change without notice. Prices do not include applicable taxes, vehicles, tires, rims, installation or optional equipment as shown. Please do not return purchases to the store. For information regarding warranty, repair, or any questions or concerns, call 901-300-4878.

AZG0226

# POWER TOOLS

## Professional OEMTOOLS®

20V Max\* Li-ion  
**Heavy Duty 1/2" Impact Wrench**  
 SKU 818594 **219<sup>99</sup>**  
 24481

- Speed: 0 to 2,200 RPM and 0 to 2,900 IPM
- Nut Busting Torque: 300 Ft/Lb.
- Tightening Torque: 260 Ft/Lb.
- Weight: 8 Lb.
- Battery Light Indicators
- Charge Time: 2 Hrs.
- Includes: 4.0Ah Li-ion Rechargeable Battery with Charging Station and Sturdy Blow Mold Storage Case



20V Max\* Li-ion  
**1/2" Brushless Impact Wrench**  
 SKU 592251 **249<sup>99</sup>**  
 24486

- Variable Speed: 0 to 2,600 RPM and 0 to 3,000 IPM
- Nut Busting Torque: 300 Ft/Lb.
- Tightening Torque: 260 Ft/Lb.
- Charge Time: 2 Hrs.
- Weight: 9.28 Lb.
- Includes: Rechargeable 4.0Ah Li-ion Battery, Charging Station and Sturdy Blow Mold Storage Case



OEMTOOLS®

20V MAX\* LI-ION

BRUSHLESS MOTOR

20V Max\* Li-ion  
**1/2" Brushless Hammer Drill**  
 SKU 593469 **229<sup>99</sup>**  
 24485

- Variable Speed: 0-600 RPM and 0-2000 RPM
- Max. Torque: 310 In/Lb.
- Electric Brake
- Clutch: 21 + 1 Torque Setting
- Charge Time: 1 Hour
- Includes: Rechargeable 2.0Ah Li-ion Battery, Charging Station and Sturdy Blow Mold Storage Case



20V Max\* Li-ion  
**Cordless Angle Grinder**  
 SKU 598786 **179<sup>99</sup>**  
 24492

- Speed: 0 to 10,000 RPM
- Max. Disc Diameter: 4-1/2"
- Spindle Thread: 5/8"
- Spindle Lock: Yes
- Charge Time: 2 Hrs.
- Includes: Grinding Disc, Assist Handle, Rechargeable 4.0Ah Li-ion Rechargeable Battery and Charging Station



20V Max\* Li-ion  
**Reciprocating Saw**  
 SKU 592353 **169<sup>99</sup>**  
 24491

- Variable Speed: 0 to 3,000 RPM
- Overall Length: 14-1/4"
- Charge Time: 1 Hour
- Includes: High-Quality, Multi-Purpose Bi-Metal Reciprocating Saw Blade, Rechargeable 2.0Ah Li-ion Battery and Charging Station



20V Max\* Li-ion  
**6-1/2" Circular Saw**  
 SKU 592349 **259<sup>99</sup>**  
 24488

- No-Load Speed: 3,800 RPM
- Arbor Size: 5/8"
- Depth of Cut (at 45°): 1-9/16"
- Depth of Cut (at 90°): 2-1/8"
- Battery: 4.0Ah Li-ion
- Charge Time: 2 Hours
- Weight: 10.35 Lb.



**All Professional OEMTOOLS 20V Power Tools Work with:**

**Battery Charger**  
 SKU OSB 27333B **52<sup>99</sup>**



For OSB, Call 901-300-4878

**Replacement Batteries**

**2.0Ah**  
 SKU OSB 27333A **79<sup>99</sup>**



**4.0Ah**  
 SKU OSB 27314AM **99<sup>99</sup>**

\*With respect to 20V Max, Maximum initial battery voltage (measured without a workload) is 20 volts. Nominal voltage is 18V.

## Corded OEMTOOLS®

**Oscillating Tool**  
 SKU 592331 **94<sup>99</sup>**  
 24495

- Includes: 3-1/2" Semi-Circle Wood Saw Blade, 2" Rigid Scraper, 1-1/4" Wood Plunge Blade, Standard Sanding Pad and (3) 60/80/120 Grit Sandpapers and 6 Ft. Power Cord
- Variable Speed: 11,000 to 20,000 OPM
- Power: 2.3 Amps
- Overall Length: 14-1/2"
- Power Cord Length: 6 Ft.



**7" Variable Speed Polisher**  
 SKU 592258 **139<sup>99</sup>**  
 24496

- No-Load Speed: 1000 to 3000 RPM
- Power: 11 Amps
- Spindle Thread: 5/8"
- Spindle Lock: Yes
- Power Cord Length: 6 Ft.
- Includes: Sanding Paper, Sanding Pad, Terry Bonnet, Wool Bonnet and Foam Piece



**6" Bench Grinder With LED Light**  
 SKU OSB 80057 **129<sup>99</sup>**

- 2.1 Amp, 1/3 HP Motor Delivers Consistent Power Without Boggling Down
- Ultra-Bright LED Lights and Dual Spark Shields Protect and Illuminate
- Adjustable Work Rests and Heavy-Duty Steel Base Ensure Accuracy and Reduced Vibration
- Dual 6" Aluminum Oxide Wheels Handle Grinding, Deburring, Cleaning
- Max Speed: 3450 RPM



For OSB, Call 901-300-4878

**Bench Grinding Wheel**  
**6" X 3/4" 46 Grit**  
 SKU 112398 **49<sup>99</sup>**  
 SHA2017

- Economical, Long Lasting Abrasive Wheels



**14" Chop Saw**  
 SKU 1228718 **279<sup>99</sup>**  
 24723

- Ideal for Cutting Wood, Metal, Steel and Pipe
- 15 Amp Motor for Powerful Cutting Action
- Spindle Lock Makes Wheel Changes Quick and Easy
- Accepts Standard 14" Cutoff Discs
- Includes: Cutting Blade and 6 Ft. Power Cord



## OEMTOOLS®

20V Max\* Li-ion  
**3/8" Cordless Drill**  
SKU 052383 **67<sup>99</sup>**  
24660

- Chuck Size: 1/2" Keyless Jacob's Chuck
- No-Load Variable 2 Speed Gear Box: 0 to 350 RPM and 0 to 1,150 RPM
- Max. Torque: 220 In/Lb.
- Max. Drilling Capacity: 5/16" (Metal) and 3/4" (Wood)
- Keyless, Auto Spindle Lock Chuck Size: 3/8"
- Clutch: 16 + 1 Torque Clutch Setting
- Electric Brake
- Forward and Reverse Switch
- Battery Charge and Capacity Indicator Lights
- Charge Time: 4 to 6 Hrs.
- Includes: 1.5Ah Li-ion Rechargeable Battery and Battery Charger



**STORE STOCKED**

20V Max\* Li-ion  
**3/8" Cordless Impact Wrench**  
SKU 052379 **82<sup>99</sup>**  
24661

- Anvil: Heat-Treated 3/8" Drive Ball Detent
- Variable Speed: 0 to 2,400 RPM and 0 to 3,000 IPM
- Max. Torque: 200 Ft/Lb. (Forward) and 240 Ft/Lb. (Reverse)
- Battery: 1.5Ah Li-ion
- Electric Brake
- Battery Charge and Capacity Indicator Lights
- Charge Time: 3 to 5 Hrs.
- Includes: 1.5Ah Li-ion Rechargeable Battery and Diagnostic Fast Battery Charger



**STORE STOCKED**

20V Max\* Li-ion  
**1/2" Cordless Impact Wrench**  
SKU 052380 **99<sup>99</sup>**  
24670

- Anvil: 1/2" Square Drive
- Speed: 0 to 2,200 RPM; 0 to 2,700 IPM
- Nut Busting Torque: 300 Ft/Lb.
- Max. Tightening Torque: 240 Ft/Lb.
- Battery: 2.0Ah Li-ion
- Weight: 6.5 Lb.
- Charge Time: 5 to 7 Hrs.
- Includes: 2.0Ah Li-ion Rechargeable Battery, Li-ion Battery Charger



**STORE STOCKED**

**Individual Batteries and Charger Available**

20V Max\* Li-ion  
**Battery 1.5 Amps**  
SKU 029415  
24660A **59<sup>99</sup>**  
• Charges in 4 to 6 Hrs.



20V Max\* Li-ion  
**Battery 2.0 Amps**  
SKU 1392334  
24670-36 **57<sup>99</sup>**  
• Charges in 4 to 6 Hrs.



20V Max\* Li-ion  
**Battery Charger**  
SKU 029418  
24660B **19<sup>99</sup>**



**4-1/2" Compact Angle Grinder**  
SKU 052382 **43<sup>55</sup>**  
24663

- Motor: 6 Amp
- Voltage: 120V, 60 Hz
- Speed: 10,500 RPM
- Interchangeable Handle for Left or Right Hand Use
- Heavy Duty, Cast Aluminum Gear Head for Strength and Durability
- 6 Ft. Power Cord
- Includes: Grinding Wheel, Spanner Wrench and Disc Guard



**STORE STOCKED**

**Heavy Duty 1/2" Impact Wrench**  
SKU 052388 **69<sup>99</sup>**  
24666

- Input Power: 8.5 Amp
- Voltage: 120V, 60 Hz
- 1/2" Square Drive with Hog Ring Retainer
- No-Load Speed: 0 to 2,200 RPM and 0 to 3,000 IPM
- Replaceable Carbon Brushes
- 8 Ft. Power Cord



**STORE STOCKED**

**Rotary Tool with 35 Piece Accessory Kit**  
SKU 052384 **39<sup>99</sup>**  
24664

- Input Power: 1.2 Amp
- Voltage: 120V, 60 Hz
- No-Load Speed: 10,000 to 35,000 RPM
- Collet Capacity: 1/8" to 3/32"
- Spindle Lock for Easy Bit and Accessory Change
- 6 Ft. Power Cord
- Includes: Grinding Stones, Wheels, Brush, Sanding Bands and Disc, plus Grinding, Cloth and Cut-Off Wheels



**STORE STOCKED**

**Flexible Shaft Rotary Tool Extension**  
SKU 003483 **19<sup>99</sup>**  
24657

- Easily Attaches to Many Popular Rotary Tools



12V Max\*\* Li-ion  
**Power Ratchet**  
SKU 1069064 **69<sup>99</sup>**  
24685

- Max. Torque: 35 Ft./Lb.
- Max. Manual Torque: 96 Ft./Lb.
- No-Load Speed: 230 RPM
- Ergonomic Grip with Low-Profile Head for Work in Tight Spaces
- Features Integrated Worklight for Hard-to-See Spots
- Includes: 2Ah Li-ion Removable Battery and Charger



**STORE STOCKED**

**Dual Temp Heat Gun**  
SKU 052387 **29<sup>69</sup>**  
24665

- Input Power: 10 Amp
- Voltage: 120V, 60 Hz
- Temperature Settings: 482°F/842°F
- Trigger: 3 Position Rocker
- Hanging Loop for Storage
- 6 Ft. Power Cord



**STORE STOCKED**

\*With respect to 20V Max, Maximum initial battery voltage (measured without a workload) is 20 volts. Nominal voltage is 18V.

\*\*With respect to 12V Max, Maximum initial battery voltage (measured without a workload) is 12 volts. Nominal voltage is 10.8V.

Prices subject to change without notice. Prices do not include applicable taxes, vehicles, tires, rims, installation or optional equipment as shown. Please do not return purchases to the store. For information regarding warranty, repair, or any questions or concerns, call 901-300-4878.

# POWER TOOLS

## Power Tool Accessories

### 33 Piece Impact Rated Driving Bit Set

SKU 750443 25960 **18<sup>99</sup>**

**OEM TOOLS**

S2  
STEEL

- Designed to Withstand High Torque Applications
- Reduces Wear, Stripping and Cam-Out
- Includes: Magnetic Impact Rated Bit Adapter



### 6 Piece Bi-Metal Hole Saw Set

SKU 547011 24378 **35<sup>99</sup>**

**OEM TOOLS**

- Includes: Sizes: 7/8", 1", 1-1/8", 1-1/4" and 1-1/2" (22 mm, 25 mm, 29 mm, 32 mm and 38 mm)
- Slotted Saw Allows for Easier Plug Removal
- Durable Enamel Finish Protects Against Corrosion
- Bi-Metal Construction for Increased Wear Resistance



### Multi-Purpose Drill Powered Pump

SKU 526513 24503 **48<sup>99</sup>**

**OEM TOOLS**

- Works with a Corded or Cordless Drill to Transfer the Following Liquids: Fresh Water, Sea Water, Organic Solvents, Motor Oil, Heating Oil, Insecticides and Liquid Fertilizers



### Bench Grinder, Vise and Drill Press Stand

SKU 943120 24643 **164<sup>99</sup>**

**OEM TOOLS**

- Heavy Duty Steel Construction Features Large Base to Prevent Walking or Wobbling During Operation and is Pre-Drilled for Mounting
- Top/Plate Dimensions: 13.8"(L) x 9.8"(W) x 0.2"(H)
- Overall Dimensions: 13.8"(L) x 9.8"(W) x 37.4"(H)

Multiple Mounting Configurations Fit Many Bench Grinders, Pipe Benders, Vises and Drill Presses



### 4-1/2" x 1/16" x 7/8" Cut Off Wheel Pack of 6

SKU 1485031 26510PK **19<sup>99</sup>**

**OEM TOOLS**

- 4-1/2" Wheel Diameter
- 1/16" Wheel Thickness
- 7/8" Arbor Diameter
- Will Evenly Cut Through Fiberglass, Plastic and Steel
- Arbor Diameter Fits Most Drills



### 3 Piece Spiral Step Drill Set

SKU 99189 24372 **34<sup>99</sup>**

**OEM TOOLS**

- Titanium Two-Flute Spiral for Longer Life, Faster Drilling and Less Vibration
- Split Point Generates Less Heat
- Bit One: 13 Sizes from 1/8" to 1/2"
- Bit Two: 6 Sizes from 3/16" to 1/2"
- Bit Three: 9 Sizes from 1/4" to 3/4"
- 28 Hole Sizes in 3 Bits
- Enlarge Existing Holes
- 1/4" Hex Shank To Prevent Slipping in Chuck Applicable Materials: Stainless Steel, Copper, Brass, Aluminum, Plastic and Laminates (Material Thickness of 0.125")



### 4.5" Depressed Center Grinding Wheels

SKU 1485045 SHA12734 **14<sup>99</sup>**

**SHARK USA**

- Type 27 Aluminum Oxide Grinding Wheels
- Arbor: 7/8"
- Diameter: 4.5 by 1/4"
- Hubless, 24 Grit
- Pack Contains 3 Wheels



### Nine-Step Drill Bit

SKU OSB 26537 **4<sup>99</sup>**

**OEM TOOLS**

- Sizes Include: 1/4", 5/16", 3/8", 7/16", 1/2", 9/16", 5/8", 11/16" and 3/4"



For OSB, Call 901-300-4878

**OEM TOOLS**

## THE SPECIALTY TOOLS YOU NEED

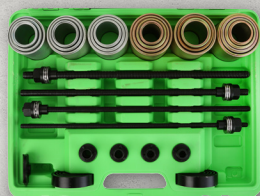

27212 Manual Bushing Installation and Removal Tool Set



27066 AirVac Cooling System Kit



27113 18 Piece Disc Brake Caliper Set



37089 Ball/U-Joint Press with 4WD Adapter Set



24549 Automotive Bearing Cup Installer



24539 Automotive U-Joint Puller



27178 Master Inner Tie Rod Tool Set



Prices subject to change without notice. Prices do not include applicable taxes, vehicles, tires, rims, installation or optional equipment as shown. Please do not return purchases to the store. For information regarding warranty, repair, or any questions or concerns, call 901-300-4878.

# TECHNICIAN SETS

TO ORDER, contact your Commercial Sales Manager or go to [AutoZonePro.com](http://AutoZonePro.com)

POWER TOOLS

## Apprentice Starter Set

SKU 227300 | 24964

**3,299<sup>99</sup>** REG. \$3,855.51

**SAVE \$555**

**Includes 337 of the Most Common Tools and Tool Cart**

- SAE and Metric, 1/4", 3/8" and 1/2" Drive Tools including Hex and Star sockets, Air Tools, Combination Wrench Sets, Pliers and Screwdrivers. Plus Tools for Battery Service, Oil Change, Wheel Service and More.

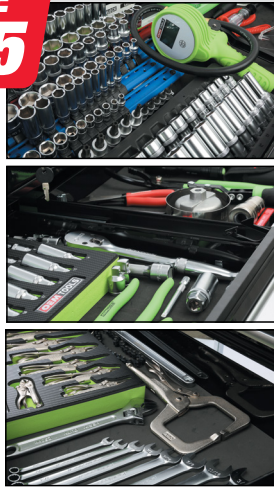

Image is for Illustration Only. Tools and Cart May Vary. See Website for Complete Component List.



Go to [AZTOOL1.com](http://AZTOOL1.com) for 24964 Contents List

Offer Good While Supplies Last Through June 30, 2026

## Lube Tech Set

SKU 227302 | 24965

**1,899<sup>99</sup>** REG. \$2,252.99

**SAVE \$353**

**Includes 160 of the Most Common Tools and Tool Cart**

- SAE and Metric, 1/4", 3/8" Drive Tools, Combination Wrench Sets, Pliers and Screwdrivers. Plus Battery Service Tools, Oil Change Tools and More



Image is for Illustration Only. Tools and Cart May Vary. See Website for Complete Component List.



Go to [AZTOOL1.com](http://AZTOOL1.com) for 24965 Contents List

Offer Good While Supplies Last Through June 30, 2026

## Mechanics Set

SKU 0533204 | 24974

**1,999<sup>99</sup>** REG. \$2,355.51

**SAVE \$355**

**Includes 156 of the Most Common Tools and Tool Cart**

- SAE and Metric, 1/4", 3/8" and 1/2" Drive Tools, Combination Wrench Sets, Pliers and Screwdrivers. Plus Battery Service Tools, Oil Change Tools and More

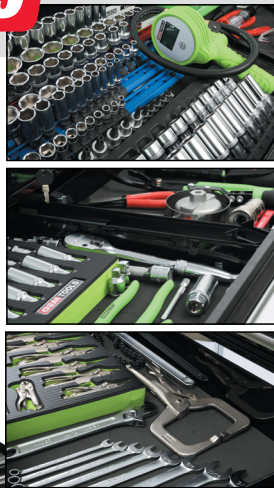

Image is for Illustration Only. Tools and Cart May Vary. See Website for Complete Component List.



Go to [AZTOOL1.com](http://AZTOOL1.com) for 24974 Contents List

Offer Good While Supplies Last Through June 30, 2026

## Technicians Set

SKU 533203 | 24975

**2,649<sup>99</sup>** REG. \$3,203.22

**SAVE \$553**

**Includes 312 of the Most Common Tools and Tool Cart**

- SAE and Metric, 1/4", 3/8" and 1/2" Drive Tools, Combination Wrench Sets, Pliers and Screwdrivers. Plus Battery Service Tools, Oil Change, Wheel Service and More



Image is for Illustration Only. Tools and Cart May Vary. See Website for Complete Component List.



Go to [AZTOOL1.com](http://AZTOOL1.com) for 24975 Contents List

Offer Good While Supplies Last Through June 30, 2026

Prices subject to change without notice. Prices do not include applicable taxes, vehicles, tires, rims, installation or optional equipment as shown. Please do not return purchases to the store. For information regarding warranty, repair, or any questions or concerns, call 901-300-4878.

# ALIGNMENT

Ask About Special Pricing on Additional Multi-Lifts and Package Deals, Call 901-300-4878

**SAVE \$1,099\***

## geoliner® 609 with 12K 4-Post Lift

SKU OSB  
ALIGNCOMB020 **37,899<sup>99</sup>**

- Provides Accurate, Real-time Measurements - Reduces Setup and Measurement Times While Generating Serious Productivity Benefits
- Ultra Low-Profile Design Allows Easy-On Approach Angle for Low Profile Vehicles
- Hydraulic Cylinder Mounted Underneath Runway
- Closed Front Design

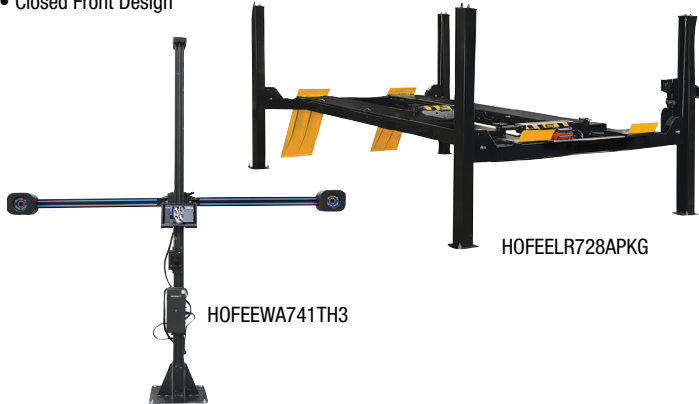

HOFEWA741TH3

HOFEELR728APKG

\* Savings based on the price of items if purchased separately.

**ALIGNER INCLUDES:** Manufacturer's Set-Up

**INCLUDES:** (2) Rolling Jacks, Air Line Kit, Premium Turn Plates and Rollback Kit

**WARRANTY:** 1 Year Parts and Labor

**SAVE \$1,399\***

## geoliner® 678 Complete Alignment System with 12,000 Lb. Scissor Lift

SKU 1350794  
ALIGNCOMB026 **57,199<sup>99</sup>**

- Includes: Geoliner® 678 Aligner w/AC400 Clamps and VIN Reader, 12,000 Lb. Scissor Lift with (2) Rolling Jacks, Air Line Kit, Turn Plates and Rollback Kit
- Open Front Design Provides Easy Access to Alignment Service and Calibration Areas
- 24" Wide Runways Provide Easy Drive-On for Large Vehicles
- 70" Lifting Height



HOFR709APKG



HOFA715TBV3

\* Savings based on the price of items if purchased separately.

**SAVE \$1,299\***

## 4 Post Alignment Lift Package (Open-Front)

SKU OSB  
BEN14AXCOMB3 **17,799<sup>99</sup>**

- 14,000 Lb. Lift Capacity
- Overall Length: 243"
- Runway Width: 20.5"
- Includes: Lift, (2) 7,000 Lb. Rolling Jacks, Turn Plates, Slip Plates and Air Line Kit



\* Savings based on the price of items if purchased separately.

**INCLUDES:** (2) Rolling Jacks, Turn Plates, Slip Plates and Air Line Kit

**SAVE \$1,199\***

## 4 Post Alignment Lift Package

SKU OSB  
BEN14LSXECMB2 **16,699<sup>99</sup>**

- 14,000 Lb. Lift Capacity
- Overall Length: 271"
- Runway Width: 20"
- Includes: Lift, (2) 7,000 Lb. Rolling Jacks, Turn Plates, Slip Plates and Air Line Kit



\* Savings based on the price of items if purchased separately.

**WARRANTY:** 1 Year Parts and Labor



Customer Responsible For Offloading, Liftgate Service Available.

For OSB, Call 901-300-4878

- Free Delivery in 48 Continental United States
- Specifications Subject to Change without Notice or Liability
- Equipment Lead Times and Shipping May Vary
- Customers Responsible for Offloading Equipment Upon Arrival
- Leasing Terms Available, Ask Your AutoZone® Commercial Sales Manager.

Prices subject to change without notice. Prices do not include applicable taxes, vehicles, tires, rims, installation or optional equipment as shown. Please do not return purchases to the store. For information regarding warranty, repair, or any questions or concerns, call 901-300-4878.

## Aligners



### CEMB Wheel Alignment Systems

- User Friendly Software with Adjustment Graphics
- More Than 55,000 Vehicles In Database
- Cloud Based Wi-Fi Networking
- 12" to 24.5" Clamping Range
- For Cars and Light Trucks



CMBDWA1100TROLL

### Trolley Wheel Alignment System

SKU OSB  
CMBDWA1100TROLL

**12,699<sup>99</sup>**

- Toughpad with 10" Touch Screen, Waterproof, Dustproof Rubberized Case

### Complete Wheel Alignment System

SKU OSB  
CMBDWA1100CWAS

**18,799<sup>99</sup>**

- Portable Wheel Stands with Integral Turn Plates on All Four Stands Align All Vehicles
- Stands Weight Limit: 10,000 Lb. or 2,500 Lb. per Stand
- Includes: Stands, Roller and Plates

### Wheel Alignment System

SKU OSB  
CMBDWA1100

**16,499<sup>99</sup>**

- Includes: Cabinet, Printer, Depressor, Holder and Software

**ALIGNER INCLUDES:**  
Manufacturer's Set-Up and Training

**WARRANTY:**  
2 Years Parts, 1 Year Labor



### DWA3500 3D High Definition Wheel Alignment System

SKU OSB  
CMBDWA3500 **20,399<sup>99</sup>**

- 3D HD Camera Technology
- Portable Cabinet/Tower Moves Bay-to-Bay
- Adjustable Camera Height Follows Alignment Rack
- Complete 4-Wheel Alignment System
- Includes: 24" Monitor, Color Printer, Compact Wheel Targets and User-Friendly Software
- FREE 1-Year Spec Update and Shop Alignment Banner



**ALIGNER INCLUDES:**  
Manufacturer's Set-Up and Training

**WARRANTY:**  
2 Years Parts, 1 Year Labor

### CWA 6500 Wheel Aligner

SKU OSB  
AMM8006500 **28,649<sup>99</sup>**

- Comes with Both Self-Centering Clamp and Exclusive Tire Gripping Adapters to Ensure Both Accurate Reading and Fast Operation
- Multiple Compensation Modes to Make Getting Readings on Heavy Vehicles Easy without Having to Roll Vehicle Excessively Far
- Two Wheel Alignment Mode for Setting Total Tow on Large Trucks, No Rear Targets Required
- Standard VIN Scanner for Time Savings and Ease of Vehicle Selection
- Mobile Cabinet Supports Using Aligner in Multiple Bays



**coats**

**ALIGNER INCLUDES:**  
Manufacturer's Set-Up and Training

**WARRANTY:**  
1 Year Parts,  
6 Months Labor, 30 Days Wheel Clamps

### Mobile Tablet Aligner

SKU OSB  
ROTR1065 **11,949<sup>99</sup>**

- Tablet Operated  
No PC Required
- Wifi Communication  
No Cables
- 4 Sensors
- 2CCD Cameras Each
- Sensor Cart Charging Built-In
- 4 Point Clamps



**Rotary**

**ALIGNER INCLUDES:**  
Manufacturer's Set-Up

**WARRANTY:**  
3 Years Parts and  
1 Year Labor



Customer Responsible For Offloading, Liftgate Service Available.

For OSB, Call 901-300-4878

- Free Delivery in 48 Continental United States
- Specifications Subject to Change without Notice or Liability
- Equipment Lead Times and Shipping May Vary
- Customers Responsible for Offloading Equipment Upon Arrival
- Leasing Terms Available, Ask Your AutoZone® Commercial Sales Manager.

Prices subject to change without notice. Prices do not include applicable taxes, vehicles, tires, rims, installation or optional equipment as shown. Please do not return purchases to the store. For information regarding warranty, repair, or any questions or concerns, call 901-300-4878.

# ALIGNMENT

## Aligners

### geoliner® 770 AC400 Clamps and VIN Reader

SKU OSB  
HOFEEWA752BV3 **28,999<sup>99</sup>**

- Lightweight, 3-Camera System Folds to a Compact Size with a Low Center of Gravity, Taking Up Less Floor Space in the Shop and Easily Maneuverable When Needed
- Touchless AC400 Wheel Clamping System (Only the Tire is Contacted), Installed in Seconds with a Single, Fast-Action Adjustment Knob
- Automatic Height Tracking to Provide Optimum Placement of its Advanced XD Targets and Cameras for More Speed and More Accuracy on Every Alignment
- Diagnostic Alignment with "Compensate Warn Alert" Intervention Gets it Right the First Time
- Video Speed Cameras Constantly Monitor Alignments, Providing Information at Every Step
- Unique Camera Beam Design Fits Through a Standard Doorway and Protects Cameras
- Next Generation UI Optimized for the High Volume User
- Highly Accurate and Reliable XD Camera Technology



### geoliner® 609 Alignment System

SKU OSB  
HOFEEWA741TH3  
**16,999<sup>99</sup>**

- Groundbreaking User Interface Provides Instant Access to Critical Tasks
- No Calibrations Required
- Designed for a Connected World
- Small Footprint
- Includes: AC200 Clamps

**WARRANTY:**  
1 Year Motor and Parts,  
6 Months Labor,  
3 Years Circuit Boards,  
Pods and Electronics

**ALIGNER INCLUDES:**  
Manufacturer's Set-Up



### geoliner® 660 Imaging Wheel Aligner

SKU OSB  
HOFEEWA712TH3 **19,999<sup>99</sup>**

- Advanced XD Cameras and Sophisticated Monitoring Algorithms
- Exclusive Dimensioning and Productivity Features
- Patented EZ-TOE – Turn the Front Wheels and Access Difficult Adjustment Points While Still Displaying Centered Toe Readings
- Features Easy-Rolling Casters, Storage for All Attachments and a Fully Enclosed Printer Compartment
- Includes AC200 Clamps, Brake Pedal Depressor, Color Ink-Jet Printer and Steering Wheel Holder



**WARRANTY:**  
1 Year Motor and Parts, 6 Months Labor,  
3 Years Circuit Boards, Pods and Electronics

**ALIGNER INCLUDES:**  
Manufacturer's Set-Up

### geoliner® 678 Wheel Alignment System with AC400 and VIN

SKU OSB  
HOFA715TBV3 **25,199<sup>99</sup>**

- Easy to Use Interface - 3 Levels of Intervention ("Compensate - Warn - Alert") with Corrective Actions Just One Click Away
- Help Videos - View Detailed Videos of How to Make Needed Adjustments to Complete Even the Most Complex Tasks
- Cross-Diagonal Measurements Identify Frame or Structural Damage (Saving Time)
- Rolling Radius Identifies Mismatched Tire Sizes to Prevent Vehicle Pulling and Drive Train Damage
- Touchless AC400 Wheel Clamping System (Only the Tire is Contacted), Installed in Seconds with a Single Fast-Action Adjustment Knob

**WARRANTY:**  
1 Year Motor and Parts, 6 Months Labor,  
3 Years Circuit Boards, Pods and Electronics

**ALIGNER INCLUDES:**  
Manufacturer's Set-Up



## Alignment Accessories

### Steel Turn Plates

SKU OSB  
QSP25-140  
**Call for Price**

- Capacity: 4,500 Lb. per Plate
- Dimensions: 14" x 14" x 1.5"



### Stainless Steel Turn Plates

SKU OSB  
QSP25-129  
**Call for Price**



### Rear Slip Plate Add-On Kit

SKU OSB  
QSPDB-6000  
**Call for Price**

- (2) 59-1/2" x 20" Full Floating Rear Slip Plates
- Simple Installation On Most General Service Lifts
- Length Options: 173", 186" to 196" and 200" to 205"
- Turn Plates Not Included



### Steering Wheel Holder and Pedal Depressor Kit

SKU 802195  
24231 **79<sup>99</sup>**

- Holds Steering Wheel in Position for Alignment Adjustments
- Depresses Brake Pedal for Various Brake Checks Including Brake Lamp Operation
- Simply Hand Squeeze the Actuator to Accomplish Fine Adjustments

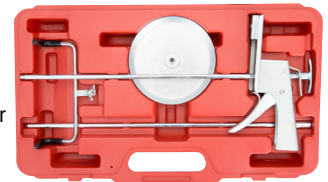

For Pricing, Call Your Commercial Sales Manager



Customer Responsible For Offloading.

For OSB, Call 901-300-4878

- Free Delivery in 48 Continental United States
- Specifications Subject to Change without Notice or Liability
- Equipment Lead Times and Shipping May Vary
- Customers Responsible for Offloading Equipment Upon Arrival
- Leasing Terms Available, Ask Your AutoZone® Commercial Sales Manager.

## Alignment Lifts



### 12,000 Lb. Scissor Alignment Lift

SKU 1350795  
HOFR709APKG **33,399<sup>99</sup>**

- Open Front Design Provides Easy Access to Alignment Service and Calibration Areas
- 24" Wide Runways Provide Easy Drive-On for Large Vehicles
- Dual Engaging Twin Interlocking Mechanical Safety Racks with Pneumatic Release
- 95 Second Lifting Time and 45 Second Lowering Time
- 70" Lifting Height



**INCLUDES:** Rolling Bridge Jacks, Air Line Kit and Turn Plates

**WARRANTY:**  
1 Year Parts and Labor



### 14,000 Lb. 4 Post Alignment Lift

SKU OSB  
FORCRA14 **22,899<sup>99</sup>**

- Max. Rise: 80-3/4"
- Max. Wheelbase: 182-1/2"
- 4 Wheel Alignment from 88" to 157"
- Long Lasting, High Performance Cable and Sheave System



**INCLUDES:** Rear Slip Plates, (2) 7,000 Lb. Rolling Jacks, Radius Gauges and Internal Air Line

**WARRANTY:**  
1 Year Parts and Labor



### 15,000 Lb. 4 Post Open Front Alignment Rack Package - Ext. Length

SKU OSB  
CHLAR4115XAO **33,149<sup>99</sup>**

- Max. Wheelbase: 210"
- Improved 4-Wheel Alignment Wheelbase with Longer Rear Slip Plates
- Removable Lock without Dropping the Column
- Enclosed Column with No Outside Lubrication
- Improved Column and Cross Beam Design
- Increased Drive Through Clearance
- 26" Wide Runways
- 78" Rise Height



**WARRANTY:**  
2 Year Parts, 1 Year Labor

**INCLUDES:** Air Line Kit, Slip Plates, Turn Plates and Two Rolling Jacks



### 4 Post Alignment Lift Combo

SKU OSB  
BEN14LSXCOMB1 **16,099<sup>99</sup>**

- 14,000 Lb. Capacity
- Overall Length: 241"
- Runway Width: 20"



**WARRANTY:**  
1 Year Parts and Labor

**INCLUDES:** Air Line Kit, Slip Plates, Turn Plates and Two Rolling Jacks



### 14,000 Lb. Scissor Alignment Lift Package

SKU OSB  
AMM8KSC14KITP **45,149<sup>99</sup>**

- Max. Service Wheelbase: 198"
- Max. 4 Wheel Alignment Wheelbase: 160"
- Max. 2 Wheel Alignment Wheelbase: 178"
- Ceiling Height Required: 12'
- Overall Length: 260"
- Overall Width: 91-1/2"
- Lifting Height: 74"



**INCLUDES:** 2 HD Rolling Jacks, 2 SS Turn Plates, 2 Roll Back Bars and 1 Airline Kit

**WARRANTY:**  
1 Year Parts and 6 Months Labor



### 15,000 Lb. 4 Post Open Front Ext. Alignment Lift Pkg

SKU OSB  
AMM8K4P15XKITP **41,049<sup>99</sup>**

- Max. 4 Wheel Alignment Wheelbase: 164-1/2"
- Max. 2 Wheel Alignment Wheelbase: 209"
- Ceiling Height Required: 12' Raised Height: 75"
- Overall Length: 287-1/2"
- Overall Width: Front 143" to Rear 137-1/2"



**INCLUDES:** 2 HD Rolling Jacks, 2 SS Turn Plates, 2 Roll Back Bars and 1 Airline Kit

**WARRANTY:**  
1 Year Parts and 6 Months Labor



Customer Responsible For Offloading.

For OSB, Call 901-300-4878

- Free Delivery in 48 Continental United States
- Specifications Subject to Change without Notice or Liability
- Equipment Lead Times and Shipping May Vary
- Customers Responsible for Offloading Equipment Upon Arrival
- Leasing Terms Available, Ask Your AutoZone® Commercial Sales Manager.

Prices subject to change without notice. Prices do not include applicable taxes, vehicles, tires, rims, installation or optional equipment as shown. Please do not return purchases to the store. For information regarding warranty, repair, or any questions or concerns, call 901-300-4878.

For Pricing, Call your Commercial Sales Manager

## Alignment Combo

### CK-14KACX-IWA *Call for price*

iDEAL Alignment Lift & Wheel Aligner Combo Bundle Kit

SKU: 429041

- High Performance Commercial Alignment Lift
- Durable, High Quality Cable Lift System
- Extended Rise Height
- 'Bolt-On' Runway Alignment Kit
- 18 Locking Height Positions
- 20" Wide Runways
- Slack Cable Safety Devices
- Self-Chocking Approach Ramps W/ Nylon Rollers
- Wide Scope High Resolution 3D Industrial Grade Cameras

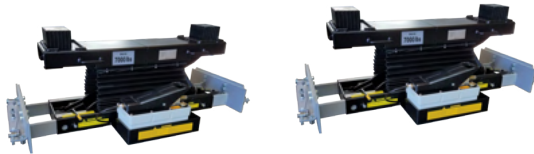

Combo Bundle Kit Includes (1) FP14KAC-X Alignment Lift, (1) Airline Kit, (1) Set of Turntables w/ Rollback Spacers (2) RAJ-7K-H Bridge Jacks & (1) IAW-60-2000T-K iPRO Wheel Aligner

## Heavy Equipment

*Call for price*

### PSB-SDD26B-3PH-230V-AK

Side Down Paint Booth

SKU 592190

*\*Single and 3 phase available\*  
Ask about our other PB options!*

- Inside Dimensions 26' L X 14' W X 9'3"H
- 5/16" Bolt & Nut Assembly
- 18 Gauge Panels
- UL Listed Dayton 24" Tube-Axial Fan



### MSC-18K-X-472

ALI Certified Mobile Columns



SKU 000942100

- 72,000lb Capacity
- 24VDC Battery Operation w/ Onboard Charging System
- Synchronized Operation
- Independent Locking Systems

*Call for price*

*Ask about our other HD mobile column options!*



## Two Post Lifts

*Call for price*

### TP11KC-DX

11,000lbs CAPACITY

SKU 426140

- Direct "Pull" Cylinders
- Overall Height: 145"
- Overall Width: 145-1/2"
- 3 Stage Front Arms,
- Low Profile Arms
- Rubber Door Guards
- Spin Up Pads with stackable drop in Height Adapters



8G DRAIN  
8 Gallon Drain  
SKU 426733

### TP9KACX

9,000lbs CAPACITY

SKU 426138

- Asymmetric Arms
- Overall Height: 143"
- Overall Width: 138"
- Spin Up Pads with stackable drop-in height adapters



*Call for price*

Floorplate Options Available!

## Single Column

*Call for price*

### MSC-6KLP

iDEAL Mobile Single Column Lift

SKU 000426460

- 6,000 lbs Capacity
- Low Profile Design
- Portable
- Single Point Lock Release
- 21 Locking Positions
- Stackable Height Extensions Included



## Storage Lifts

*Call for price*

### FP8K-DX-XLT

8,000lbs CAPACITY

SKU 426415

- Extended Lift Height & Length
- Cable Driven Lifting System
- Single Point Manual Lock Release
- Slack Cable Safety
- Steel Approach Ramps
- Adjustable Locking Positions



Also available in 9,000lb Capacity!

### SP-6K-SS

6,000lbs CAPACITY

SKU 000426416

- 6,000lb Capacity
- Low Post Height for Low Ceilings
- Low Profile Ramps
- Ability to install on Right or Left Side
- Single Point Lock Release



*Call for price*

## Wheel Service

### TC-950/WB953 *Call for price*

Tire Changer & Wheel Balancer Combo

SKU 000880175

- Max Wheel Diameter: 39"
- Rim Width: 1.5" - 20"
- Rim Diameter: 10" - 24"
- Wheel Weight Capacity: 150 lbs

- Max Wheel Diameter: 47"
- Rim Width: 3" - 15"
- Rim Diameter: 15" - 28"



WW-BASIC  
Basic Wheel Weight Kit  
SKU 000426813

*Call for price*

• Free Delivery in 48 Continental United States • Equipment Lead Times and Shipping May Vary  
• Customer is Responsible for Offloading Equipment Upon Arrival

# AUTOMOTIVE LIFTS

FOR HELP with Selection, Confirm Availability and Ordering Instructions, Call 901-300-4878

AUTOMOTIVE LIFTS

## Challenger Lifts

### 10,000 Lb. 2 Post Offset Arm Design Lift

SKU OSB CHLVLE10 **5,799<sup>99</sup>**

#### Versymmetric® 3-Stage Offset Front Arms

- Lifts Asymmetric and Symmetric in the Same Service Bay
- Rubber Door Guards



Versymmetric® Technology

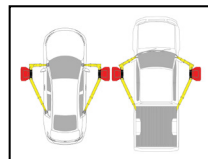

Available in Red and Blue



**INCLUDES:** Telescoping Footpads

**WARRANTY:** 1 Year Parts and Labor

### 10,000 Lb. 2 Post Versymmetric® Adjustable Lift

SKU 1544683 CHLCL10AV3 **7,724<sup>99</sup>**

#### 3-Stage Front, 3-Stage Rear Arms with Swept Arm Design

- 3 Adjustable Widths and 2 Adjustable Heights
- Can Be Set Up to Lift Most EVs
- Arm Reach: Front - Min. 20", Max. 42" Rear - Min. 37-5/8", Max. 60"
- Ceiling Height Required: 12' Minimum
- Width: 14' Recommended



Versymmetric® Technology

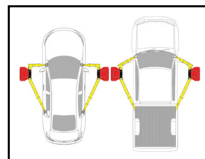

Available in Red, Blue and Black



**INCLUDES:** Telescoping Footpads

**WARRANTY:** 2 Years Parts and 1 Year Labor

### 12,000 Lb. 2 Post Symmetric Lift

SKU 1580894 CHLLE12-3S **10,734<sup>99</sup>**

- Heavy Duty 3-Stage Front and Rear Arms
- Single-Point Mechanical Lock Release
- Adjustable Column Height: 166" or 175"
- Padded Overhead Shut-Off System
- Powder Coat Finish
- Standard Dual Integrated Rubber Door Guards
- Includes: (4) 3" Stack Extensions, (2) 6" Stack Extensions and (2) Organizer Racks with Hardware



Available in Red and Blue

**WARRANTY:** 1 Year Parts and Labor

### 12,000 Lb. 2 Post Symmetric Lift

SKU OSB CHLLE12 **9,699<sup>99</sup>**

### 14,000 Lb. 4 Post Closed Front Lift

SKU OSB CHL4P14EFX **9,089<sup>99</sup>**

- 20" Wide Runways
- Max. Wheelbase: 182.5"
- Minimum Bay Size: 12' x 24'
- Rise Height: 78"
- Color: Black Only

**Air Line Kit**  
SKU 1580944 CHL40230E **744<sup>99</sup>**



**WARRANTY:** 1 Year Parts and Labor  
Rolling Jacks Sold Separately

### 12,000 Lb. 2 Post Symmetric Lift

SKU OSB CHLCL12A **11,724<sup>99</sup>**

- 3-Stage Front and Rear Arms Provide Extension and Retraction to Lift Everything from Small Sedans to Pickup Trucks
- Adjustable Height: 158" to 164"
- Adjustable Width: 142"/148"/154"
- Includes 10315 Stack Adapter Kit, (4) 3" Stack Adapters, (2) 6" Stack Adapters, (2) Organizer Racks with Hardware



Available in Red, Blue and Black

**WARRANTY:** 2 Year Parts, 1 Year Labor

### One 7,500 Lb. Rolling Jack

SKU OSB CHLRJ75 **4,524<sup>99</sup>**



Optional Equipment

**WORKS WITH**

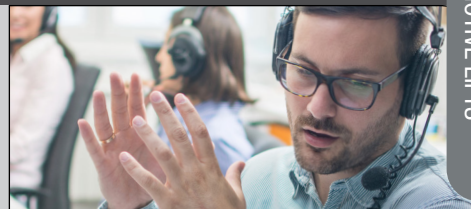

## BEFORE PLACING YOUR AUTOMOTIVE LIFT ORDER:

Please verify minimum ceiling height, concrete requirements and bay size. See page 2 for delivery information or **Call 901-300-4878.**

## Quality Lifts

**quality lifts**

### 10,000 Lb. 2 Post Lift

SKU 1580947 CHLEQ10 **5,364<sup>99</sup>**

- 3-Stage Front, 2-Stage Rear Arms
- Lifts Symmetrically or Asymmetrically
- Ceiling Height Required: 12'
- Rubber Door Guards
- Padded Overhead Shut-Off Bar
- Single-Point Lock Release System
- Color: Black Only



**INCLUDES:** (4) 3" Stack Adapters and Drop-In Footpads

**WARRANTY:** 6 Months Parts and Labor

## UPGRADE YOUR QUALITY LIFT

### Double Telescoping Footpads (4 Pack)

SKU 1580892 CHLB2270PK4 **524<sup>99</sup>**

- 10,000 Lb. Footpads
- Fits Quality 10,000 Lb. 2 Post Lifts
- Single Pad Features Frame Engaging Ears



### (2) 6" Stack Adapters

SKU OSB CHL10313 **251<sup>99</sup>**

- Upgrade for CHLEQ10 Lift



### 12,000 Lb. 2 Post Heavy Duty Lift Screw-Style Footpad

SKU 1580890 CHLB12162S-12 **104<sup>99</sup>**

- Fits Challenger and Quality 12,000 Lb. Heavy Duty 2 Post Lifts
- Single Pad Features Frame Engaging Ears



Customer Responsible For Offloading.

For OSB, Call 901-300-4878

- Free Delivery in 48 Continental United States
- Specifications Subject to Change without Notice or Liability
- Equipment Lead Times and Shipping May Vary
- Customers Responsible for Offloading Equipment Upon Arrival
- Leasing Terms Available, Ask Your AutoZone® Commercial Sales Manager.

Prices subject to change without notice. Prices do not include applicable taxes, vehicles, tires, rims, installation or optional equipment as shown. Please do not return purchases to the store. For information regarding warranty, repair, or any questions or concerns, call 901-300-4878.

AZG0226

# AUTOMOTIVE LIFTS

## Coats Lifts

### 10,000 Lb. 2 Post Lift with 3 Stage 2n1 Arms

SKU OSB AMM4TV21NSR1 **8,249<sup>99</sup>**

- 90" Offset 3-Stage Front and Rear Arms for Asymmetric or Symmetric Vehicle Positioning
- Includes: Door Bumper Guards and Lifting Adapters
- Premium U.S. Made Power Unit
- Overall Height: 138" or 148"



**WARRANTY:**  
1 Year Parts, 6 Months Labor

### 12,000 Lb. 2 Post Lift with 3 Stage Symmetric Straight Arms

SKU OSB AMM4T212SSR1 **10,999<sup>99</sup>**

- Includes: Door Bumper Guards and Lifting Adapters
- Overall Width: 137-1/8"
- Overall Height: 154-7/8" or 158-7/8"
- Color: Red



**WARRANTY:** 1 Year Parts, 6 Months Labor

## Forward Lifts

### 10,000 Lb. F10 2 Post Lift

SKU OSB FORF10N500MBK **6,149<sup>99</sup>**

- 3-Stage Front Arms and Two-Stage Rear Arms
- Includes: Drop In Adapters and 4 Extensions
- Overall Height: 141"
- Color: Black



**INCLUDES:**  
Truck Adapters

**WARRANTY:**  
1 Year Parts and Labor

### 110 10,000 Lb. 2 Post Lift

SKU OSB FOR110 **6,649<sup>99</sup>**

- Smooth Lifting and Long Life with Forward's Direct Pull Cylinders
- Spot-Rite™ 3-Stage Front Arms, 2-Stage Rear Arms
- 76-1/4" Rise
- Available in Black Only



**INCLUDES:**  
Truck Adapters

**WARRANTY:**  
1 Year Parts and Labor

### 112 Symmetrical Two Post Lift 12K Capacity

SKU OSB FOR112N300BK **11,149<sup>99</sup>**

- 3-Stage Front and Rear Arms
- Includes: Drop-In Adapters with 4 Extensions
- Overall Height 166"
- Color: Black



**INCLUDES:**  
Truck Adapters

**WARRANTY:**  
1 Year Parts and Labor

### 14,000 Lb. CR14L 4 Post Lift

SKU OSB FORCR14L **8,999<sup>99</sup>**

- Heavy Duty Hydraulic Cylinder
- Single Point Latch Release System
- 78-3/4" Rise
- 18 Lock Positions
- Accommodates 182-1/2" Wheelbase Vehicles
- High Performance Cable and Sheave System



### Internal Air Line Kit

SKU OSB ROTFC5760-14 **699<sup>99</sup>**

Rolling Jacks Sold Separately  
**WARRANTY:**  
1 Year Parts and Labor

### One 7,000 Lb. Rolling Jack

SKU OSB FORRRJ70G **4,499<sup>99</sup>**



### Two 7,000 Lb. Rolling Jacks

SKU OSB FORRRJ70GB0G0 **6,749<sup>99</sup>**

Optional Equipment

Offer Valid Only with Purchase of Forward 4 Post Lift

## Rotary Lifts

### 10,000 Lb. 2 Post Asymmetric Lift with AV Arms - Blue

SKU 1580893 ROTSPA10AVBL **10,919<sup>99</sup>**

- Easy Spotting and Positioning
- Highest Capacity Low-Profile Lift Available
- Comes Standard with Adjustable Round, Truck and Stackable Adapter Extensions
- Overall Width: 11' 5-1/2"
- Overall Height: 11' 11-1/2"
- Arm Reach: Front: Min. 18-1/2" - Max. 41", Rear: Min. 27-5/8" - Max. 58-1/4"
- Max Rise: 81-1/2"
- Drive-Thru Clearance: 95-1/4"
- Min. Bay Size: 12' x 24'

**WARRANTY:** 1 Year Parts and Labor



Shown with Additional Accessories

### 14,000 Lb. 4 Post Lift

SKU OSB ROTSM14L **11,989<sup>99</sup>**

- Filter/Regulator/Lubricator Included to Extend the Life of Lift and Tools
- Max. Wheel Base: 182"
- 78" Rise
- Long Lasting Cables and Sheaves

Rolling Jacks Sold Separately

### Internal Air Line Kit

SKU OSB ROTFC5760-14 **699<sup>99</sup>**



**WARRANTY:**  
1 Year Parts and Labor

## WORKS WITH

### One 7,000 Lb. Rolling Jack

SKU OSB ROTRJ7100Y **5,649<sup>99</sup>**

Optional Equipment



Customer Responsible For Offloading.

For OSB, Call 901-300-4878

- Free Delivery in 48 Continental United States
- Specifications Subject to Change without Notice or Liability
- Equipment Lead Times and Shipping May Vary
- Customers Responsible for Offloading Equipment Upon Arrival
- Leasing Terms Available, Ask Your AutoZone® Commercial Sales Manager.

Prices subject to change without notice. Prices do not include applicable taxes, vehicles, tires, rims, installation or optional equipment as shown. Please do not return purchases to the store. For information regarding warranty, repair, or any questions or concerns, call 901-300-4878.

# AUTOMOTIVE LIFTS

FOR HELP with Selection, Confirm Availability and Ordering Instructions, Call 901-300-4878

AUTOMOTIVE LIFTS

## BendPak® Lifts

### 10,000 Lb. 2 Post Lifts

- Bi-Metric™ Reversible Triple Telescoping Swing Arms
- Low-Pro™ Swing Arms
- Automatic Arm Restraints
- Expandable Top Beam Accommodates Wide or Narrow Drive-Thru Configurations

SKU 1360698 | BEN10AP

**6,099<sup>99</sup>**

- Height: 145"
- Width: 135" to 145"
- Rise: 69"



SKU OSB BEN10APX

**6,899<sup>99</sup>**

- Height: 157"
- Width: 135" to 145"
- Rise: 75.5"

SKU OSB BEN10AP-168

**6,599<sup>99</sup>**

- Height: 168"
- Width: 135" to 145"
- Rise: 69"

SKU OSB BEN10APX-181

**7,499<sup>99</sup>**

- Height: 181"
- Width: 135" to 145"
- Rise: 75.5"

- 24" Bolt-On Extension for Increased Vehicle Height Clearance

WARRANTY: 1 Year Parts and Labor

## BendPak®

### 12,000 Lb. 2 Post BiMetric Lift

SKU OSB BEN12APX **10,049<sup>99</sup>**

- Adaptable Design: Symmetric or Asymmetric
- Automatic Swing Arm Restraint System
- Includes: 4 Frame Cradle Pads, 4 Medium and 4 Tall Stacking Adapters



### 12,000 Lb. 2 Post Short-Rise Floorplate Lift

SKU OSB BEN12AP-SRT

**8,749<sup>99</sup>**

- Post Height: 93.5"
- Max. Lifting Height: 46"

Great Choice for Low Ceiling Height Where You Do Not Need to Work Underneath the Vehicle



INCLUDES: 4 Frame Cradle Pads, 4 Medium and 4 Tall Stacking Adapters



WARRANTY: 1 Year Parts and Labor

### 16,000 Lb. 2 Post Lift

SKU OSB BEN16AP **21,349<sup>99</sup>**

- Telescoping Arms Accommodate a Wide Variety of Vehicle Chassis
- Dual Direct-Drive Hydraulic Cylinders for Smoother Operation and Less Maintenance
- Includes: 4 Frame Cradle Pads, 4 Medium and 4 Tall Stacking Adapters with Column-Mounted Racks



INCLUDES: 4 Frame Cradle Pads, 4 Medium and 4 Tall Stacking Adapters



WARRANTY: 1 Year Parts and Labor

### 10,000 Lb. Low-Rise Lift

SKU 1275473 BENLR-10000 **5,099<sup>99</sup>**

- Min. Height: 4.5"
- Max. Lift Height: 23"
- Lift Height + Blocks: 32"



4.5" to 32"

WARRANTY: 1 Year Parts and Labor

### 7,000 Lb. Full-Rise Scissor Lift

SKU OSB BENSP-7XE **10,799<sup>99</sup>**

- Full-Rise Scissor Design Provides Clear Access
- Open-Center Platform Ideal For Exhaust, Transmission, And Brake Work
- Ultra-Low Profile For Easy Drive-On and Drive-Off
- 68" Rise Height, 84" Overall Length, 78.5" Overall Width, 63" Platform Length, 21" Platform Width, 220V, 1-Phase Power



WARRANTY: 1 Year Parts and Labor

### 6,000 Lb. Low-Rise Pad Lift

SKU 210383 BENLR-60 **2,999<sup>99</sup>**

- Min. Height: 3.5"
- Max. Lifting Height: 23"
- Max. Lift Height + 1.5" Blocks: 24.5"



3.5" to 24.5"

WARRANTY: 1 Year Parts and Labor



Customer Responsible For Offloading.

For OSB, Call 901-300-4878

- Free Delivery in 48 Continental United States
- Specifications Subject to Change without Notice or Liability
- Equipment Lead Times and Shipping May Vary
- Customers Responsible for Offloading Equipment Upon Arrival
- Leasing Terms Available, Ask Your AutoZone® Commercial Sales Manager.

Prices subject to change without notice. Prices do not include applicable taxes, vehicles, tires, rims, installation or optional equipment as shown. Please do not return purchases to the store. For information regarding warranty, repair, or any questions or concerns, call 901-300-4878.

AZG0226

# AUTOMOTIVE LIFTS

## BendPak® Lifts

### 14,000 Lb. 4 Post Lift

SKU **OSB**  
**BENHDS14**

**8,299<sup>99</sup>**

- Overall Width: 130"
- Overall Length: 241"
- Max. Rise: 70"
- Motor: 220 VAC/1 Ph



Shown with Optional Equipment  
Rolling Jacks Sold Separately  
WARRANTY: 1 Year Parts and Labor

### Air Line Kit

SKU **OSB**  
**BEN5174009**

**159<sup>99</sup>**

## WORKS WITH

### One 7,000 Lb. Capacity Rolling Bridge Jack

SKU **OSB**  
**BENRJ7W** **2,499<sup>99</sup>**



Optional Equipment

### 9,000 Lb. 4 Post Lift

SKU **OSB**  
**BENHD-9**

**5,699<sup>99</sup>**

- Overall Width: 110.25"
- Overall Length: 174"
- Column Height: 88" (2,235 mm)
- Max. Lifting Height: 74-1/2" (1,892 mm)



Shown with Optional Equipment  
Rolling Jacks Sold Separately  
WARRANTY: 1 Year Parts and Labor

### Air Line Kit

SKU **OSB**  
**BEN5174009**

**134<sup>99</sup>**

## WORKS WITH

### One 4,500 Lb. Capacity Rolling Bridge Jack

SKU **OSB**  
**BENRJ45W** **2,449<sup>99</sup>**



Optional Equipment

## Atlas Equipment

### Commercial Grade Overhead 2 Post Lift 15,000 lb. Capacity

SKU **OSB**  
**ATLXH-PV15PX-FPD** **7,949<sup>99</sup>**

- Extra Tall and Extra Wide
- Adjustable Height: 165" (13' 9") or 177" (14' 9")
- Special Low Height: 150" (12' 6") (Requires Purchase of Extra Cables)
- Symmetric Arms



WARRANTY: 2 Years Parts Only

### Heavy Duty Truck Wheel Balancer

SKU **OSB**  
**ATLATWBT-210-FPD** **6,149<sup>99</sup>**

- Computer Controlled Heavy Duty Spin Balancer
- Plastic Quick Release Nut and Heavy Duty Steel Wing Nut Included
- Pneumatic Wheel Lift (External Air Supply Required - Not Included)
- Automatic Start/Stop When Hood is Lowered/Raised
- Static and Dynamic Balancing Modes
- Includes: Cone Sets for Car and Light Truck Tires
- Includes: Cone and Spacer Set for Truck, Bus, or Implement Tires



WARRANTY: 1 Year Parts Only

### 14,000 Lb. 4 Post Lift

SKU **OSB**  
**ATLAP-PVL14-FPD** **10,249<sup>99</sup>**

- Lifting Height: 76-1/2"
- Clearance Under Runways: 69-1/2"
- Width of Columns (with Motor): 140-1/2"
- Length with Approach Ramp: 251-1/2"
- Runway Width: 20"
- Rolling Jacks Sold Separately



WARRANTY: 2 Years Parts Only

### 12,000 Lb. Heavy Duty 2 Post Lift

SKU **OSB**  
**ATLXH-PV12PXFDP** **6,449<sup>99</sup>**

- Adjustable Height: 165" (13' 9") or 177" (14' 9")
- Special Low Height: 150" (12' 6") (Requires Purchase of Extra Cables)
- Symmetric Arms
- Automatic Arm Restraints

WARRANTY: 2 Years Parts Only

### 12,000 Lb. 2 Post Lift

SKU **OSB**  
**ATLAP-PVL12-FPD** **8,899<sup>99</sup>**

- Low Pad Height Allows Lift to Accommodate Both Long Wheelbase Trucks and Passenger Cars
- Extra Tall and Extra Wide
- 3-Stage Symmetric Arms
- 8 Piece Truck Adapter Set

WARRANTY: 2 Years Parts Only



Customer Responsible For Offloading.

For OSB, Call 901-300-4878

- Free Delivery in 48 Continental United States
- Specifications Subject to Change without Notice or Liability
- Equipment Lead Times and Shipping May Vary
- Customers Responsible for Offloading Equipment Upon Arrival
- Leasing Terms Available, Ask Your AutoZone® Commercial Sales Manager.

# AUTOMOTIVE LIFTS

FOR HELP with Selection, Confirm Availability and Ordering Instructions, Call 901-300-4878

AUTOMOTIVE LIFTS

## Mid-Rise Lifts

**BendPak**

### 6,000 Lb. Portable Mid-Rise Lift

SKU 210386 **3,399<sup>99</sup>**  
BENMD-6XP

- Portable, Easy to Move from Bay to Bay
- Adjustable Arms



**INCLUDES:**  
Truck Adapters

**WARRANTY:**  
1 Year Parts and Labor

**CL Challenger Lifts**

### 6,000 Lb. Mid-Rise Portable Lift

SKU 1580897 **4,249<sup>99</sup>**  
CHLMR6

- 6 Safety Lock Positions
- Short and Tall Auxiliary Adapters Come Standard
- Sliding/Rotating Arm Design Reaches Pick-Up Points on a Wider Range of Vehicles
- Zerk Fittings on Pivot Points for Serviceability



**WARRANTY:**  
1 Year Parts and Labor

**CL Challenger Lifts**

### 10,000 Lb. Short Rise Lift

SKU OSB **6,134<sup>99</sup>**  
CHLSRM10

- Min. Height: 4.25"
- Max. Height: 22"
- Includes: (4) 2 Position Adapter Blocks
- Three Locking Positions for Ease of Use
- Color: Black Only

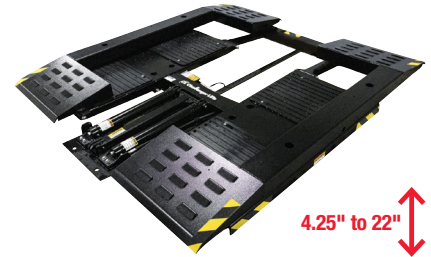

**WARRANTY:**  
1 Year Parts and Labor

## MaxJax Lift

**MAXJAX**

### MaxJax M7K

SKU 1360718 **4,699<sup>99</sup>**  
MJXM7K

- Min. Pad Height: 5.5"
- Height Overall: 89.5"
- Max. Lift Height: (Pad Only) 47.25" (With 3" Adapter) 50.5"
- Clear Undercar Access
- Portability
- Stow to Go in Less Than 15 Minutes



**WARRANTY:** 1 Year Parts and Labor

## QuickJack™ Lifts

**QUICKJACK™**

### You get it all.

- Complete Package Includes: 2 Jack Frame Assemblies, (2) 150" Hydraulic Hoses, (2) 14" Aux. Hoses, 2 Quick-Mount Handles, (4) 1.5" x 3" x 4" Rubber Lifting Blocks, (4) 3" x 3" x 4" Rubber Lifting Blocks, 1 Mini Hydraulic Power Unit with Pendant Control



### 8000TLX Extended-Length Portable Truck and SUV Lift

SKU OSB **2,299<sup>99</sup>**  
QJK8000TLX

- Capacity: 8,000 Lb.
- 66" Lift Point Reach
- Fast and Easy Setup
- Stackable Rubber Blocks
- Automatic Safety Locks
- Increased Lifting Height
- Undercarriage Access
- One Handed Operation



### QuickJack™ SUV and Light Truck Adapters

SKU 862288 **249<sup>99</sup>**  
RAN5150561

- Fits BL-5000 and BL-7000 Series
- Set of 12 Pieces Includes: 4 Low Profile Round Polyurethane Contact Pads, 4 Sliding Receivers That Accommodate the Round Polyurethane Contact Pads and (4) 3" Stackable Adapters



## Motorcycle Lift

**OEM TOOLS**

### Air Hydraulic Motorcycle Lift 1,000 Lb. Capacity

SKU 662742 **1,199<sup>99</sup>**  
24859

- Our Lift Compares to Top Brand Motorcycle Lifts in Every Way
- 86.5" x 26.75" Platform Deck with 25.5" Long Removable Loading Ramp
- Built-In Casters and Adjustable Stabilizers
- Durable 12 Gauge, Powder Coated Diamond Plate Deck
- Air/Hydraulic Lift System Allows Use with Shop Air or as a Manual Lift
- Tie Down Rings on Deck for Added Stability



Heavy Duty, Positive Stop, Padded Wheel Vise

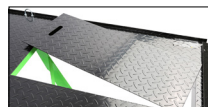

Rear Dropout Panel (for Rear Tire Maintenance Access)



Customer Responsible For Offloading.

For OSB, Call 901-300-4878

- Free Delivery in 48 Continental United States
- Specifications Subject to Change without Notice or Liability
- Equipment Lead Times and Shipping May Vary
- Customers Responsible for Offloading Equipment Upon Arrival
- Leasing Terms Available, Ask Your AutoZone® Commercial Sales Manager.

Prices subject to change without notice. Prices do not include applicable taxes, vehicles, tires, rims, installation or optional equipment as shown. Please do not return purchases to the store. For information regarding warranty, repair, or any questions or concerns, call 901-300-4878.

AZG0226

95

# AUTOMOTIVE LIFTS

## Lift Pads



### Forward/Eagle/Gemini/ Worth/American Hexagon Shaped - 2 Bolt Style Lift Pads (Set of 4)

SKU 1137807 **89<sup>99</sup>**  
SHA51663

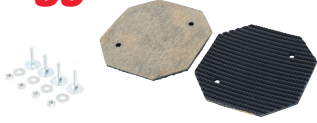

### Fits Models

I-DP9, DP09A2,  
DP09A, DP07A,  
DP97A, DP7A,  
Eagle and Other  
Texas Style  
2 Post Lifts

### Replaces

OEM#  
994105,  
991234,  
991222 and  
LP603

### Hexagon Shaped - 2 Bolt Style Lift Pads (Set of 4)

SKU 1137812 **119<sup>99</sup>**  
SHA51661



20000, 21000,  
26000, 27000,  
28000, 30000,  
31000, 33000,  
36000, 37000,  
39000

OEM#  
JOK01D,  
LP602

### Challenger Rubber Round Slip-On Lift Pad (Single)

SKU OSB **23<sup>99</sup>**  
CHLB2208



For OSB, Call 901-300-4878

Challenger CL10, E10,  
Q10, VS10 and  
Ammco AC21NS

N/A

### Quality Round Slip-On Lift Pads (Set of 4)

SKU 1137816 **54<sup>99</sup>**  
SHA51673



VS10, CI10, E10,  
TLT210, TLT210-AS,  
TLT211, TLT211-AS,  
ACD210S and More

OEM#  
104130315,  
B2208

### Rotary Square Bolt Style Lift Pads (Set of 4)

SKU 1137817 **114<sup>99</sup>**  
SHA51667



SPO9, SPOA9,  
SPO10, SPOA10,  
SPO12, SI29,  
SL19, SL210

OEM#  
FJ6213,  
BH-7536-92P,  
BH7542-73  
and LP609

### BendPak Square Slip-On Lift Pads (Set of 4)

SKU 1137805 **129<sup>99</sup>**  
SHA51666

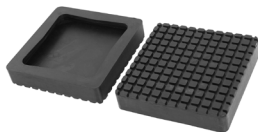

MX10AC, MXACX,  
X10CX, MX10C,  
XPR-9S, XPR-9S-LP,  
XPR-9DS, XPR-10S,  
XPR-10S-LP,  
XPR-10S-168,  
XPR-10AS,  
XPR-10AS-LP,  
XPR-10AS-168,  
XPR-12FDL,  
XPR-12CL, XPR-15CL,  
XPR-18CL,  
XPR-12CL-192,  
XPR-15CL-192,  
XPR-18CL-192, RJ6,  
RJ6000, RJ4500

OEM#  
5715-365  
and LP608

## Challenger



### Electric Vehicle Footpad (Set of 4)

SKU 1544676 **809<sup>99</sup>**  
CHLEVPK

- Designed Specifically to Work on Electric Vehicles
- Fits All 10K and 12K 2 Post and Inground Lifts
- Double-Screw-Up for Finer Adjustments
- Low Profile, Fits in Small Places
- Durable, Thin Pad

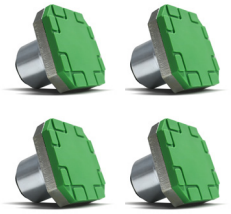

### Truck Adapter Set for 10,000 Lb. and 12,000 Lb. 2 Post Lifts

SKU OSB **613<sup>99</sup>**  
CHL10315

- Stack Adapter Extension Kit Includes:  
(4) 3" Stack Extensions,  
(2) 6" Stack Extensions and  
2 Organizer Racks with Hardware



### GM Wide Frame Footpads (Pair)

SKU OSB **759<sup>99</sup>**  
CHLB2280PR

- Fits 2008 and Up Challenger Lifts CL10V3, E10, LE10,  
VLE10, SA10, CLFP9, E12, CL12 and EV1020 Models
- Works on 2019 GMC Sierra and Chevrolet  
Silverado Half-Ton Trucks
- Drop-In Design Makes Switching Simple and Quick
- Telescoping Feature Provides Simple  
Access to Lift Points



For OSB, Call 901-300-4878

## BendPak

### Rubber 2 Post Lift Pad/Slip Over (Set of 4)

SKU 954179 **89<sup>99</sup>**  
BEN5700227

- Heat and Cold Resistant
- Highly Resistant to Gouging
- Oil and Solvent Resistant
- Tear Resistant



## BendPak

### Lift Pad Assembly/ 35 mm Pin (Set of 4)

SKU 1053947 **209<sup>99</sup>**  
BEN5215753

- Works with Any BendPak 2 Post Lift
- Thick Rubber Construction
- Textured Surface for Extra Grab
- Will Not Scratch the Vehicle
- Easy Drop-In Design
- 5" Diameter for  
Enhanced  
Stability



### Cradle Pads

- Tactile Rubber Pad Reduces Slippage and Protects the Finish
- Made for Heavy Duty Commercial-Grade Trucks
- Installs Easily to BendPak 2 Post Lift Arms
- Sturdy Steel Construction

### Frame Cradle Pads 35 mm Pin (Set of 4)

SKU 954221 **216<sup>99</sup>**  
BEN5215754



### Wide Frame Cradle Pads 60 mm (Set of 2)

SKU 979067 **196<sup>99</sup>**  
BEN5215848



Prices subject to change without notice. Prices do not include applicable taxes, vehicles, tires, rims, installation or optional equipment as shown. Please do not return purchases to the store. For information regarding warranty, repair, or any questions or concerns, call 901-300-4878.

## 2-POST LIFTS

**APEX**  
by BendPak

**NEW!**

**AL9LC 9K Capacity  
2-Post Lift**  
SKU OSB  
APEAL9LC

**\$3,929<sup>99</sup>**  
FREE SHIPPING!\*

- Max. Rise - 70"
- Overall Height - 109.5"
- Overall Width - 137.25"

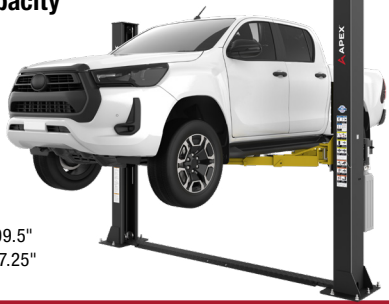

**AL10C 10K Capacity  
2-Post Lift**  
SKU OSB  
APEAL10C

**\$4,199<sup>99</sup>**  
FREE SHIPPING!\*

- Max. Rise - 70"
- Overall Height - 148"
- Overall Width - 137.25"



**9APF 9K lb. Capacity  
Floorplate 2-Post Lift**  
SKU OSB BEN9APF

**\$6,299<sup>99</sup>**  
FREE SHIPPING!\*

- Max. Rise - 70"
- Overall Height - 123"
- Overall Width - 136" or 146"



**BendPak.**

## 2-POST LIFTS

**10AP 10K lb. Capacity Clearfloor  
2-Post Lift**  
SKU OSB BEN10AP

**\$6,099<sup>99</sup>** FREE SHIPPING!\*

- Max. Rise - 69"
- Height - 145" / Width - 135" - 145"



**10AP-168 10K lb. Capacity Clearfloor  
2-Post Lift / Extended Height**  
SKU OSB BEN10AP-168

**\$6,599<sup>99</sup>** FREE SHIPPING!\*

- Max. Rise - 69"
- Height - 168" / Width - 135" - 145"



24" Column Extension  
Included on 168 & 181 Models

**10APX 20K lb. Capacity Clearfloor  
2-Post Lift / High-Rise**  
SKU OSB BEN10APX

**\$6,899<sup>99</sup>** FREE SHIPPING!\*

- Max. Rise - 76.5"
- Height - 157" / Width - 135" - 145"



**10APX-181 20K lb. Capacity Clearfloor  
2-Post Lift / High-Rise / Ext. Height**  
SKU OSB BEN10APX-181

**\$7,499<sup>99</sup>** FREE SHIPPING!\*

- Max. Rise - 76.5"
- Height - 181" / Width - 135" - 145"



**FEATURES**  
AUTOMATIC SWING ARM  
RESTRAINT SYSTEM



**360° ASARS**



## 2-POST LIFTS

**12APX 12K lb. Capacity Clearfloor  
Super-Duty 2-Post Lift**  
SKU OSB BEN12APX

~~\$10,495~~ **\$10,049<sup>99</sup>** FREE SHIPPING!\*

- Max. Rise - 76"
- Height - 169" / Width - 168"



**INCLUDES**



**12APX-192 20K lb. Capacity  
Clearfloor Super-Duty 2-Post Lift**  
SKU OSB BEN12APX-192

**\$11,499<sup>99</sup>** FREE SHIPPING!\*

- Max. Rise - 76.5"
- Height - 169" / Width - 168"



## 2-POST LIFTS

**16AP-192 16K lb. Capacity Clearfloor  
Super-Duty 2-Post Lift / Ext. Height**  
SKU OSB BEN16AP-192

~~\$22,795~~ **\$22,449<sup>99</sup>** FREE SHIPPING!\*

- Max. Rise - 76"
- Height - 169" / Width - 168"

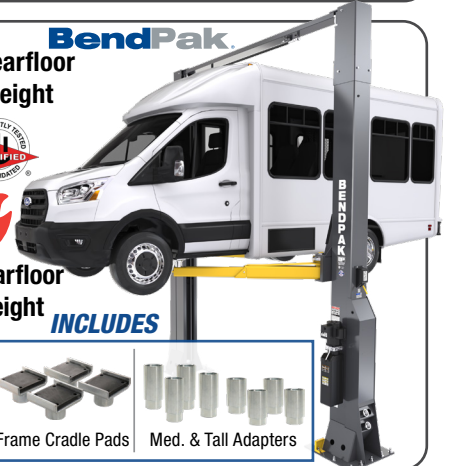

**INCLUDES**



**20AP-192 20K lb. Capacity Clearfloor  
Super-Duty 2-Post Lift / Ext. Height**  
SKU OSB BEN20AP-192

~~\$25,595~~ **\$23,899<sup>99</sup>** FREE SHIPPING!\*

- Max. Rise - 76.5"
- Height - 169" / Width - 168"



## ALIGNMENT COMBOS

**HDS-14LSX Combo Deal**  
SKU OSB BEN14LSXCOMB1

~~\$16,895~~ **\$16,099<sup>99</sup>** FREE SHIPPING!\*

- INCLUDES:**
- (1) HDS-14LSX Closed-Front 4-Post Alignment Lift
  - (1) Airline Kit
  - (2) RJ7W Rolling Jacks

**SAVE BIG!**

- HDS14LSX Specs:**
- Capacity - 14,000 lbs.
  - Max. Rise - 70"
  - 130" (W) / 242" (L)

**HDS-14LSXE Combo Deal**  
SKU OSB BEN14LSXECMB2

~~\$17,495~~ **\$16,549<sup>99</sup>** FREE SHIPPING!\*

- INCLUDES:**
- (1) HDS-14LSXE Closed-Front 4-Post Alignment Lift
  - (1) Airline Kit
  - (2) RJ7W Rolling Jacks

**SAVE BIG!**

- HDS14LSXE Specs:**
- Capacity - 14,000 lbs.
  - Max. Rise - 70.75"
  - 130" (W) / 272" (L)

**HDSO-14AX Combo Deal**  
SKU OSB BEN14AXCOMB3

~~\$18,895~~ **\$17,699<sup>99</sup>** FREE SHIPPING!\*

- INCLUDES:**
- (1) HDSO-14AX Open-Front 4-Post Alignment Lift
  - (1) Airline Kit
  - (2) RJ7W Rolling Jacks

**SAVE BIG!**

- HDSO-14AX Specs:**
- Capacity - 14,000 lbs.
  - Max. Rise - 77.5"
  - 143.25" (W) / 244.5" (L)



**HDSO-14AX  
Open-Front  
Alignment Lift**

\*Free shipping to direct shipping points within the 48 contiguous states (excluding surcharges). Additional delivery surcharges may apply for special delivery needs.

Prices subject to change without notice. Prices do not include applicable taxes, vehicles, tires, rims, installation or optional equipment as shown. Please do not return purchases to the store. For information regarding warranty, repair, or any questions or concerns, call 901-300-4878.

## TIRE CHANGERS

**R76ATR Tilt-Back Power Assist**  
SKU OSB RANR76ATR

**\$6,999<sup>99</sup>**

~~\$7,395~~

**HOT DEAL**

**FREE SHIPPING!\***



- Int. Clamping - 10" - 30"
- Ext. Clamping - 10" - 16"

**R980DP Swing-Arm Dual Assist Tire Changer**  
SKU OSB RANR980DP

**\$7,299<sup>99</sup>**

~~\$7,795~~

**FREE SHIPPING!\***

**HOT DEAL**



**Ranger**

- Int. Clamping 10" - 30"
- Ext. Clamping 9" - 26"

**R80EX Dual-Assist Tilt-Back Tire Changer**  
SKU OSB RANR80EX

**\$11,099<sup>99</sup>**

**FREE SHIPPING!\***

- Int. Clamping 13" - 34"
- Ext. Clamping 10" - 30"



**R26FLT Heavy-Duty Tire Changer**  
SKU OSB RANR26FLT

**HEAVY-DUTY**

- Max. Rim Diameter - 14" - 26"
- Max. Tire Diameter - 63"

**\$12,799<sup>99</sup>**

**FREE SHIPPING!\***

**POWERFUL HIGH SPEED 3HP 220V MOTOR**



## WHEEL BALANCERS

**DST-2420 Wheel Balancer**  
SKU OSB RANDST2420

**\$3,299<sup>99</sup>**

**FREE SHIPPING!\***



- Max. Wheel Diameter 10" - 30"
- Max. Tire Diameter - 47"
- Max. Tire Weight - 145 lbs.

**DST30PX Wheel Balancer**  
SKU OSB RANDST30PX

**\$3,399<sup>99</sup>**

~~\$3,595~~

**FREE SHIPPING!\***

**HOT DEAL**



- Max. Wheel Diameter 8" - 30"
- Max. Tire Diameter - 47"
- Max. Tire Weight - 150 lbs.

**LS45DS Wheel Balancer 3D Quick-Touch™ / Sonar-Spot™**  
SKU OSB RANLS45DS

**\$5,799<sup>99</sup>**

~~\$6,895~~

**HOT DEAL**



- Max. Wheel Diameter 12" - 24"
- Max. Tire Diameter - 43"
- Max. Tire Weight - 145 lbs.

**RB30T Heavy-Duty Wheel Balancer**  
SKU OSB RANRB30T

**\$13,499<sup>99</sup>**

~~\$14,895~~

**FREE SHIPPING!\***

**HOT DEAL**



- Max. Wheel Diameter - 24"
- Max. Tire Diameter 47.25"

## WHEEL SERVICE

**AT26A Tire Changer**  
SKU OSB APEAT26A

- Internal Clamping - 14" - 26"
- External Clamping - 12" - 24"

**APEX**  
by BendPak

**\$3,599<sup>99</sup>**

**FREE SHIPPING!\***



AB28

AT26A

**AB28 Wheel Balancer**  
SKU OSB APEAB28

**\$2,699<sup>99</sup>**

**FREE SHIPPING!\***

- Max. Wheel Diameter - 12" - 28"
- Max. Tire Diameter 44"

## SPRAY WASH CABINETS



**Ranger**

**RS-500D-601 Professional Spray Wash Cabinet**  
SKU OSB RANRS500D

**\$9,099<sup>99</sup>**

~~\$9,695~~

**FREE SHIPPING!\***

- Load Capacity - 500 lbs.
- Tank Capacity - 50 gal.
- Interior Dimensions - 43" x 32"

**HOT DEAL**

**RS-750D-601 Truck Spray Wash Cabinet**  
SKU OSB RANRS750D

**\$9,899<sup>99</sup>**

~~\$10,495~~

**FREE SHIPPING!\***

- Load Capacity - 1,000 lbs.
- Tank Capacity - 53 gal.
- Interior Dimensions - 54" x 32"

**RS-500DS-601 STAINLESS STEEL Spray Wash Cabinet**  
SKU OSB RANRS500DS

**\$14,299<sup>99</sup>**

~~\$14,895~~

**FREE SHIPPING!\***

**RS-750DS-601 STAINLESS STEEL Truck Spray Wash Cabinet**  
SKU OSB RANRS750DS

**\$15,299<sup>99</sup>**

~~\$15,895~~

**FREE SHIPPING!\***

## EVAPORATIVE AIR COOLERS

**COOL BOSS™**  
By BendPak

**CB-19L Portable Evaporative Air Cooler**  
SKU OSB CLBCB19L

~~\$975~~

**\$829<sup>99</sup>**

**HOT DEAL**



- Fan Diameter - 19"
- Water Capacity - 15 Gal
- Max. Airflow - 5,300 CFM

**CB-26SL Portable Evaporative Air Cooler**  
SKU OSB CLBCB26SL

~~\$3,295~~

**\$3,099<sup>99</sup>**

**HOT DEAL**



- Fan Diameter - 26"
- Water Capacity - 50 Gal
- Max. Airflow - 7,540 CFM

**CB-28L Portable Evaporative Air Cooler**  
SKU OSB CLBCB28L

~~\$3,695~~

**\$3,449<sup>99</sup>**

**HOT DEAL**



- Fan Diameter - 28"
- Water Capacity - 80 Gal
- Max. Airflow - 8,120 CFM

**coolee™**  
BY COOL BOSS®

**CL-240 3-in-1 Portable Air Cooler**  
SKU OSB

**\$414<sup>99</sup>**

- Air Cooler • 14 Qt. Ice Chest • Bluetooth Speakers **FREE SHIPPING!\***

CLBCL240-GB

CLBCL240-CAMO

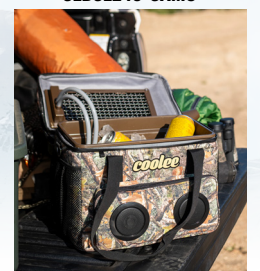

\*Free shipping to direct shipping points within the 48 contiguous states (excluding surcharges). Additional delivery surcharges may apply for special delivery needs.

Prices subject to change without notice. Prices do not include applicable taxes, vehicles, tires, rims, installation or optional equipment as shown. Please do not return purchases to the store. For information regarding warranty, repair, or any questions or concerns, call 901-300-4878.

# TIRE SERVICE

FOR HELP with Selection, Confirm Availability and Ordering Instructions, Call 901-300-4878

TIRE SERVICE

## Coats Combos

### RC-45E and 1300 Series Tire Service Combo

SKU OSB AMMCOMB04 **12,149<sup>99</sup>**

**SAVE\* \$649**

- External Rim Clamping Range from 6" -24" (Max Tire Diameter 50"; Max Rim Width 10.5")
- RC-45E Drive System: 1 HP Electric Motor
- Tire Changer Allows Inflation from 0 - 60 PSI with a Built-in Pressure Limiter
- 1300 Series is Powered by Direct Drive
- Static-On-Screen® Display Identifies Any Excess Residual Static Imbalance
- Wheel Balancer Automatically Enters 2-D Data for Wheel Diameter and Offset Measurement

AMM80013002D



AMM8560994901

**INCLUDES:** Setup and Training

AMM80013002D - WARRANTY: 3 Years Parts and 6 Months Labor  
AMM8560994901 - WARRANTY: 1 Year Parts and 6 Months Labor

\* Savings based on the price of items if purchased separately.

### RC-55E and 1300 Series Tire Service Combo

SKU OSB AMMCOMB02 **14,599<sup>99</sup>**

**SAVE\* \$699**

- RC-55E Features an External Clamping Range from 6" to 24" (Max. Tire Diameter 50"; Max. Rim Width 10-1/2")
- RC-55E Drive System: 1 HP Electric Motor
- Tire Changer Allows Inflation from 0 to 60 psi with a Built-In Pressure Limiter
- 1300 Series Wheel Balancer is Powered by Direct Drive
- Static-On-Screen® Display Identifies Any Excess Residual Static Imbalance
- Wheel Balancer Automatically Enters 2-D Data for Wheel Diameter and Offset Measurement

AMM80013002D



AMM8560995001

**INCLUDES:** Setup and Training

AMM80013002D - WARRANTY: 3 Years Parts and 6 Months Labor  
AMM8560995001 - WARRANTY: 1 Year Parts and 6 Months Labor

\* Savings based on the price of items if purchased separately.

## DON'T FORGET THESE ACCESSORIES

- Works with Coats Wheel Balancers Listed on This Page



Adjustable Pin Plate Set **1,599<sup>99</sup>**  
SKU OSB | AMM8200000400

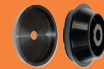

40 mm Light Truck Cone **459<sup>99</sup>**  
SKU OSB | AMM8113277C

Customize Your Own Combo, Call for Special Pricing **901-300-4878**

## Rotary Combos

### R146P and R155 Tire Service Combo

SKU OSB ROTCOMB04 **15,299<sup>99</sup>**

**SAVE\* \$499**

- Includes: R146P Tire Changer and R155 Balancer High Quality Swing Arm Changer and Pro 3D Wheel Balancer at an Economical Price
- Changer Offers 26" Outside and 28.5" Inside Clamping with Tire Diameters Up to 46"
- Built-In Air Tank and Plastic Mount/Demount Head
- Balancer Features Automatic Program, Linked Keyboard, Internal Data Gauge, and Simple Visual Display
- This Combo is Ideal for High-Volume Tire Shops and General Repair Bays

#### R146P

- Inside Clamping: 12 to 28.5"
- Outside Clamping: 10 to 26"
- 115V, Single Phase

#### R155

- Rim Diameter: 10" to 30"
- Rim Width: 1.5" to 22"
- 115V, Single Phase
- 8 Piece Collet Kit Included



ROTR155



ROTR146P

**INCLUDES:** Setup and Training

\* Savings based on the price of items if purchased separately.

WARRANTY: 3 Years Parts and 1 Year Labor

### R146P and R148 Tire Service Combo

SKU OSB ROTCOMB05 **13,299<sup>99</sup>**

**SAVE\* \$649**

- R146RP Tire Changer with Swing-Arm Design, Helper Arm and Hand Bead Breaker; Handles Wheels up to 26" Outside Clamping and Tire Diameters up to 46"
- Built-In Air Tank and Plastic Mount/Demount Head
- R148 Pro 2D Wheel Balancer Features Auto Distance and Diameter Entry, LED Display, and Split/Hidden Weight Modes
- Includes: 8 Piece Double Sided Collet Kit
- Rim Diameter: 10" to 30"
- Rim Width: 1.5" to 22"



ROTR148



ROTR146P

**INCLUDES:** Setup and Training

\* Savings based on the price of items if purchased separately.

WARRANTY: 3 Years Parts and 1 Year Labor



Customer Responsible For Offloading, Liftgate Service Available.

For OSB, Call 901-300-4878

- Free Delivery in 48 Continental United States
- Specifications Subject to Change without Notice or Liability
- Equipment Lead Times and Shipping May Vary
- Customers Responsible for Offloading Equipment Upon Arrival
- Leasing Terms Available, Ask Your AutoZone® Commercial Sales Manager.

Prices subject to change without notice. Prices do not include applicable taxes, vehicles, tires, rims, installation or optional equipment as shown. Please do not return purchases to the store. For information regarding warranty, repair, or any questions or concerns, call 901-300-4878.

AZG0226

99

# TIRE SERVICE

## CEMB Combos

### EZ10 and SM825EVOPA Swing Arm Tire Changer Combo

SKU OSB  
CMBCOMB03 **10,899<sup>99</sup>**

**SAVE\***  
**\$899**

- Tire Changer Clamping Range of 13" to 24"
- Max. Tire Diameter 44" and Max. Tire Width 15"
- Powerful and Adjustable Bead Breaker Shovel
- Dual Clamping Cylinders and Semi-Automatic Swing Arm
- 3D Wheel Measurement with Sonar
- Automatic Approach and Auto Adaptive Mode to Save Balancing Time
- Electromagnetic Brake
- 3D Inner Data Entry Arm Eliminates Rim Width Caliper Use
- Direct Measures Input Feature Eliminates Selection of Balancing Modes
- Guided Weight Placement, ALU, Hidden Spoke Modes



CMBEZ10

Includes Press Arm

CMBSM825EVOPA

\* Savings based on the price of items if purchased separately.

### ER72D Balancer and SM628BPS Tire Changer Combo

SKU OSB  
CMBCOMB04 **17,699<sup>99</sup>**

**SAVE\***  
**\$1,049**

- Includes ER72D Balancer and SM628BPS Tire Changer
- Tire Changer: Clamps Up to 28" Rims, Handles Tires Up to 44" Diameter
- Ideal for 19.5" Tires
- Balancer: Laser Weight Spotter and 3D Data Arm Entry
- Guided Weight Placement and Quick-Clamp Wing Nut



CMBER72D

CMBSM628BPS

\* Savings based on the price of items if purchased separately.

On-Site Training Included

WARRANTY: 2 Years Parts and 1 Year Labor

## Ranger Combos

### R76ATR and DST30P Tire Service Combo

SKU OSB  
RANCOMB03 **10,199<sup>99</sup>**

**SAVE\***  
**\$399**

- Inflation Pressure Regulator/Limiter
- Bead Tool/Tire Iron Automatic Braking
- Black and Silver Powder-Coated Surface Helps Eliminate Corrosion and Staining of Expensive Wheels
- Low Profile Design for Increased Clearance of Close-Proximity Calipers or Brake Components



RANR76ATR

RANDST-30P

\* Savings based on the price of items if purchased separately.

### R980XR and DST-2420 Tire Service Combo

SKU OSB  
RANCOMB01 **7,799<sup>99</sup>**

**SAVE\***  
**\$474**

- Includes: R980XR NEXTGEN™ Swing-Arm 30" Tire Changer and the DST-2420 Dynamic Wheel Balancer
- R980XR External Rim Clamping Capacity: 9" to 28", Internal Clamping 10" to 30"
- 3-Position RimGuard™ Wheel Clamps
- DST-2420 Dynamic Wheel Balancer Dependably Ensures an Accurate Result within Hundredths of an Ounce



RANDST2420

RANR980XR

\* Savings based on the price of items if purchased separately.

### R76ATR and LS45DS Tire Service Combo

SKU OSB  
RANCOMB014 **12,199<sup>99</sup>**

**SAVE\***  
**\$774**

- Includes: R76ATR Tire Changer and LS45DS Wheel Balancer
- R76ATR Tilt-Tower Tire Changer
- Handles External Rim Clamping from 9" to 28"
- Equipped with a Durable Electric Turntable with Reversible Direction
- LS45DS Sonar 3D Wheel Balancer
- Features Automatic 3D Data Entry for Faster, More Accurate Balancing
- Supports Wheel Sizes from 12" to 24"
- Accommodates Tires Up to 31.5" in Diameter



RANR76ATR

RANLS45DS

\* Savings based on the price of items if purchased separately.

User Setup Required

WARRANTY: 1 Year Parts and Labor



Customer Responsible For Offloading, Liftgate Service Available.

For OSB, Call 901-300-4878

- Free Delivery in 48 Continental United States
- Specifications Subject to Change without Notice or Liability
- Equipment Lead Times and Shipping May Vary
- Customers Responsible for Offloading Equipment Upon Arrival
- Leasing Terms Available, Ask Your AutoZone® Commercial Sales Manager.

# TIRE SERVICE

FOR HELP with Selection, Confirm Availability and Ordering Instructions, Call 901-300-4878

TIRE SERVICE

## Coats Tire Changers

### Maxx 50 Tire Changer, 110V

SKU OSB  
AMM800MAXX50E **7,449<sup>99</sup>**

- Dual Nozzle, Hi-Flow Bead Sealing System for Quick, Easy Bead Sealing
- 110V Electric Operation, Plug In Almost Anywhere
- 6" to 24" Steel Clamps Standard
- Nylon Duckhead Standard
- Expanded Capacity to 16" Wheel Width, and Up to 50" Total Diameter



### Maxx 50 Tire Changer, Air

SKU OSB  
AMM800MAXX50A **7,449<sup>99</sup>**

### Maxx 70 Tire Changer, 110V

SKU OSB  
AMM800MAXX70 **9,749<sup>99</sup>**

- Dual Nozzle, Hi-Flow Bead Sealing System for Quick, Easy Bead Sealing
- 110V Electric Operation, Plug in Almost Anywhere
- Expanded Capacity to 16" Wheel Width and Up to 50" Total Diameter
- 6" to 24" Steel Clamps Standard
- Steel and Nylon Duckheads Standard
- No-Index Tabletop for High Efficiency Use



### Maxx 70 Tire Changer, Air

SKU OSB  
AMM800MAXX70A **9,749<sup>99</sup>**

### Maxx 70 Tire Changer, 220V, 2 HP

SKU OSB  
AMM800MAXX70220 **9,749<sup>99</sup>**

### Maxx 80 Tire Changer, 110V

SKU 1354781  
AMM800MAXX80 **11,249<sup>99</sup>**

- Dual Nozzle, Hi-Flow Bead Sealing System for Quick, Easy Bead Sealing
- Dual Control, Hand or Foot Operated Bead Loosener System
- 110V Electric Operation, Plug in Almost Anywhere
- 6" to 24" Steel Clamps and Zinc Plated 6" to 24" Grip Max. 2.0 Clamps with Dual Soft Compound Inserts
- Expanded Capacity to 16" Wheel Width and Up to 50" Total Diameter
- Steel and Nylon Duckheads Standard
- No-Index Tabletop for High Efficiency Use
- Includes Storage Cabinet



### Maxx 80 Tire Changer, Air

SKU 1354782  
AMM800MAXX80A **11,249<sup>99</sup>**

### Tire Changer, 220V, 2 Speed

SKU OSB  
AMM800MX802SP **11,799<sup>99</sup>**

### Maxx 80 Tire Changer, 220V, 2 HP

SKU 1350785  
AMM800MX80220 **11,249<sup>99</sup>**

INCLUDES: Setup and Training

WARRANTY: 3 Years Parts and 6 Months Labor

## Coats Wheel Balancers

### RC450 Wheel Balancer

SKU OSB  
AMM800RC450 **4,819<sup>99</sup>**

- Fits in Small Location with Standard 110V Power
- Indirect Motor 110V
- Entry-Level Low Price Point
- 110V



WARRANTY:  
1 Year Parts  
6 Months Labor

### RC550 Wheel Balancer

### SKU OSB AMM800RC550 **6,079<sup>99</sup>**

- Fits in Small Location with Standard 110V Power
- Indirect Motor 110V
- Laser Pin Point Accuracy
- 110V



WARRANTY:  
1 Year Parts  
6 Months Labor

## coats

### 1600A 3D Wheel Balancer

SKU 82860  
AMM80016003D **11,249<sup>99</sup>**

- Powered by Direct Drive
- Max. Tire Diameter: 44"
- Premium Quicknut
- Behind-the-Spoke Balancing
- 8 Piece Collet Kit
- Automatic 3-D Data Entry
- Touch-Screen
- 220V, 1 Phase



WARRANTY:  
3 Years Parts and  
6 Months Labor

INCLUDES: Setup and Training



Customer Responsible For Offloading, Liftgate Service Available.

For OSB, Call 901-300-4878

- Free Delivery in 48 Continental United States
- Specifications Subject to Change without Notice or Liability
- Equipment Lead Times and Shipping May Vary
- Customers Responsible for Offloading Equipment Upon Arrival
- Leasing Terms Available, Ask Your AutoZone® Commercial Sales Manager.

Prices subject to change without notice. Prices do not include applicable taxes, vehicles, tires, rims, installation or optional equipment as shown. Please do not return purchases to the store. For information regarding warranty, repair, or any questions or concerns, call 901-300-4878.

AZG0226

## CEMB

### Automatic Wheel Balancer with Monitor

SKU OSB CMBER65

**6,599<sup>99</sup>**

- Auto-Data Entry of Distance, Diameter and Width
- Laser Pointer for Weight Placement
- 17" Monitor with Intuitive Software
- Auto-Approach Positions Wheel at Correction Point



On-Site Training Included

WARRANTY: 2 Years Parts and 1 Year Labor



### 3D Data Entry Wheel Balancer

SKU OSB CMBEZ15 **5,099<sup>99</sup>**

- Electro-Magnetic Brake Holds Weight Position
- Quick-Clamp Wing Nut Auto Adaptive Enhancement with Static Residual Force Minimization
- 3D Inner Data Entry Arm Eliminates Rim Width Caliper Use
- Guided Weight Placement, ALU, Hidden Spoke Mode



On-Site Training Included

WARRANTY: 5 Years Motor, 2 Years Parts, and 1 Year Labor

## Ranger

### DST-2420 Tire Balancer

SKU OSB RANDST2420 **3,399<sup>99</sup>**

- Motor: 1.5 HP, 110V/220V, 50/60 Hz, 1Ph
- Balancing Modes: Dynamic/Static/3-Alloy
- Quick-Release Hub Nut for Dramatically Reduced Set-Up Times
- Max. Tire Diameter: 47"
- Balancing Speed: 180 RPM
- Balance Increments: 0.25 or 0.01 Oz.



### R80EX Tire Changer

SKU OSB RANR80EX **11,099<sup>99</sup>**

- Ranger's Adjustable RimGuard™ Wheel Clamps Feature Internal and External Multi-Teeth Jaws
- Variable Clamp Positioning Makes Wheel Service Simple, Perfectly Controlling the Wheels When Clamping Them
- Geometric Tabletop Provides Easier Bead Lubrication Features a Multi-Axis and Adjustable Bead Loosener Shovel Blade Oversized Axle Minimizes Blade Flex and Improves Durability
- Motor: 3 HP (220 VAC 50-60 HZ)



User Set-Up Required

WARRANTY: 1 Year Parts and Labor

**40 mm Truck Cone Kit**  
SKU OSB | RAN5150032 **499<sup>99</sup>**

Works with Ranger Wheel Balancers Listed on This Page



## Hofmann

### monty® 3550EM Tire Changer with smartSpeed™

SKU OSB HOFEEWH747B **12,999<sup>99</sup>**

- smartSpeed™ Technology Automatically Controls Turntable Speed and Torque to Minimize Tire and Wheel Damage
- Push-Button Controlled Mount/Demount Head Pneumatically Lowers and Locks into Position, Automatically Indexing Away from the Wheel to Prevent Contact and Damage
- Fast and Ergonomic Pneumatic Vertical Arm Automatically Re-Positions the Mounting Head to Minimize Wheel Damage
- High Capacity Tire Changer Allows for Broadest Tire and Wheel Assembly Coverage
- Clamping Range: Inside 12" to 28"; Outside 12" to 26"
- Max. Tire Diameter: 47"
- Max. Tire Width: 17"



**INCLUDES: Setup and Training**

WARRANTY: 1 Year Parts and 6 Months Labor



### geodyna® 7600P with Laser and Power Clamp

SKU OSB HOFEEWB765AP **9,569<sup>99</sup>**

- Power Clamp Clamps Wheel Accurately with Constant Force
- Smart Sonar™ Delivers Automatic, Non-Contact Rim Width
- Acquisition Split Weight Mode, Allows Exact Placement of Weights Behind Spokes



**INCLUDES: Setup and Training**

WARRANTY: 1 Year Parts and 6 Months Labor

## Manatec



### DL-65 DSP C+ Wheel Balancer

SKU OSB MANDL65 **1,649<sup>99</sup>**

- Static and Dynamic Balancing
- Automatic Start with Wheel Guard Closure
- Unbalance Recalculation
- Self-Calibration
- 7 Modes of Alloy Wheel Functions
- Normal and Fine Measurement
- Motor Power: 0.35 HP
- Maximum Wheel Diameter: 39"



User Setup Required

WARRANTY: 1 Year Parts



Customer Responsible For Offloading, Liftgate Service Available.

For OSB, Call 901-300-4878

• Free Delivery in 48 Continental United States • Specifications Subject to Change without Notice or Liability • Equipment Lead Times and Shipping May Vary • Customers Responsible for Offloading Equipment Upon Arrival • Leasing Terms Available, Ask Your AutoZone® Commercial Sales Manager.

## TPMS Tools

### INDUSTRY-LEADING COMPATIBILITY with OE and Aftermarket TPMS Sensors

**OEM TOOLS**

**NEW**

#### TS37 TPMS Reset, Trigger and Relearn Tool with 4 Sensors

SKU **OSB** **279<sup>99</sup>**  
OEMTS374K

- Fast, Simple TPMS Relearns for Most Domestic and Import Vehicles



#### VT47 Wi-Fi TPMS Reset and Programming Tool with OBDII with 10 Sensors

SKU **OSB** **599<sup>99</sup>**  
OEMVT4710K

- Scan, Diagnose and Relearn TPMS with Built-In OBDII Support



#### VT57 All-In-One TPMS and Tire Management Tool with 20 Sensors

SKU **OSB** **1,199<sup>99</sup>**  
OEMVT5720K

- Advanced TPMS + Tire Tread Diagnostics with Full Sensor Coverage



**EACH Sensor Comes with a Rubber Valve and a Metal Stem**

For OSB, Call 901-300-4878

FUNCTIONALITY	TS37	VT47	VT57
VIN Barcode Scanner to Select Make, Model and Year			✓
Wi-Fi and Real-Time Updates Powered by Live Sensor™		✓	✓
Programs Aftermarket Sensors (Including EZ-Sensor® and All Leading Brands)	✓	✓	✓
Provides Direct (OBD, Auto, Manual) and Indirect TPMS Relearn Procedures	✓	✓	✓
98.6% TPMS Reset Coverage, Including Bonus ECU Reset Coverage in <2 Min. (OBD Connectivity)		✓	✓
ECU Unlock for Toyota, Scion and Lexus Models (Closed Loop)		✓	✓
OE and Aftermarket TPMS Sensors and Service Kits Part Number Look-Up	✓	✓	✓
Retrieves, Decodes and Clears TPMS DTCs		✓	✓
Tire Management, DOT, Tread Reading and More		✓	✓

## **AutoZone** Tool & Equipment **QUARTERLY**

**Call Us at 901-300-4878**

Get expert guidance, top brands, and full after-sale support. Our team is manufacturer-trained to help you select the right tools, check availability, and provide competitive pricing. Visit our website for even more products, [www.AZtool1.com](http://www.AZtool1.com)

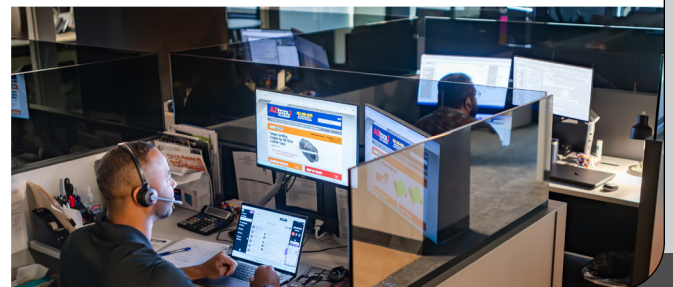

# TIRE SERVICE

CALL FOR PRICE

## MaxiTPMS® TS508 WiFi Kits SKU #1328117 | Part #700180

- Update software directly from tool-enabled Wi-Fi
- Quick Mode & Advanced Mode Options
- Read/Activate/Relearn All Known Sensors
- Detect & Display TPMS System Faults
- Display Vehicle-Specific Relearn Procedures; Perform OBDII Relearns
- Placard Value Reset on Supported Vehicles
- 2 Programming Options: MX-Sensors Only
- FREE Software for lifetime of tool
- 4 1-Sensors & Metal Valve Included



SKU #1413611  
Part #700190

SKU #1538300  
Part #700330

- 20 Rubber 1-Sensors Included
- 20 Metal 1-Sensors Included



Part #700190 SHOWN



## MaxiTPMS® ITS600PRO1 SKU #1140847 | Part #ITS600PRO1

- Complete TPMS Service and Diagnostics Tablet
- 5.5 Inch Color Touchscreen/Android 9.0 OS
- Activates, Reads and Relearns All Known Sensors
- On-Tool DOT Tire Registration
- 2 MX-Sensor Program Modes

**AUTEL**  
THE SMARTER CHOICE  
FIND OUT WHY



# AUTEL MAXITPMS

CALL FOR PRICE



## MaxiTPMS® MX-Sensor BLE SKU #1366285 | Part #300100

- Pre-programmed Bluetooth Low Energy TPMS sensors for Tesla 3/Y/S/X models
- Tesla-ready: Just Fit and Go
- Future-proof: programmable with Autel TPMS tools for the latest BLE-equipped vehicles

## MaxiTPMS® 1-Sensor | SKU #31745 | Part #1SENSOR

- Combined Frequency: 315MHz & 433MHz
- Interchangeable Valve Stems (rubber included)
- Program to Replace 99% of OE Sensors
- Fast valve stem swap

## MAXITPMS® 1-SENSORM SKU #1064478 | Part #1SENSORM

- Same as 1-Sensor with Aluminum stem



## MaxiTPMS® 1-Sensor 20-Pack (R) SKU #370328 | Part #300010

- Bulk pack of 20 1-Sensors with Rubber Valves



## MaxiTPMS® 1-Sensor 20-Pack (M) SKU #1107286 | Part #300060

- Bulk pack of 20 1-Sensors with Aluminum Valves

## MaxiTPMS® 1-Sensor 240 Pack SKU #1089240 | Part #300050

- Bulk pack of 240 1-Sensors with Rubber Valves



## MaxiTPMS® 1-Sensor 100 Pack SKU #1128315 | Part #300070

- Bulk pack of 100 1-Sensors with Rubber Valves



## MaxiTPMS® TS900 SKU 1337325 | Part #TS900

- Activate, Read, and Relearn ALL known TPMS sensors, including Tesla OE sensors
- Program universal Autel 1-Sensors to replace 99% TPMS sensors

- Compatible with BLE TPMS sensors and Autel BLE Sensor for Tesla vehicles
- Features Android 11 operating system and 64GB storage memory
- All Systems Diagnostics with bi-directional controls, Active Tests & Special Functions

## MaxiSYS® MS906 PRO2-TS SKU #1607400 | Part #MS906PRO2TS

- All systems diagnostics • 1-Sensor programming
- TPMS sensor activation/read/relearn
- Embedded TPMS antenna for broad support including for Tesla vehicles
- Secure gateway module access on newer vehicles



## MaxiTPMS® ITS600 CV SKU #1573165 | Part #700420

- Complete TPMS Service tool for Commercial Vehicles
- Industry-leading coverage for TPMS-enabled Trucks, Trailers, Buses
- Program Autel MX-Sensor CVS-A01433 MHZ Sensor to replace OE and programmed aftermarket sensors
- Separate Tractor & Trailer interfaces display up to 46 wheels & 12 axles
- Includes Deutsch 6 and 9-pin, and UNIU-4 DLC adapters

## NEW HEAVY DUTY TPMS SERVICE

## MX-Sensor CVS-A01 TPMS Sensor for Commercial Vehicles

### SKU #1573139 | Part #300170

Includes metal band to attach sensor to rim, compatible with rims sized 14 to 24.5-inches

### SKU #1573138 | Part #300190

Includes fabric band to attach sensor to rim, compatible with rims sized 14-17.5-inches

### SKU #1573141 | Part #300210

Includes metal band to attach sensor to rim, compatible with rims sized 17.5 to 24.5-inches



**AUTEL**

## Inflators

OEM TOOLS

### Digital Tire Inflator

SKU 802198 24412 **79<sup>99</sup>**

- Easy-to-Read Backlit LCD Display
- 4 Units of Measure (psi, Bar, KPa, kgf)
- Measuring Range: 0 to 175 psi (0 - 12 Bar)
- Accuracy: +/-1.2 psi Up to 58 psi, +/-2.3 Between 58 psi and 145 psi Inclusive, +/-3.6 psi Greater Than 145 psi
- High Air Flow Saves the Technician Time



OEM TOOLS

### Dial Tire Inflator

SKU 301772 24380 **89<sup>99</sup>**

- Clear and Easy-to-Read 80 mm 180 psi Gauge
- 3-In-1 Function: Inflate, Deflate and Measure Tire Pressure
- Increased Accuracy to Improve Tire Performance and Prevent TPMS Comebacks



## Wheel Stud Tools

### Wheel Stud Installer

SKU 339123 24234 **14<sup>99</sup>**

- Works with Hubs, Rotors and Axles on Both Front and Rear Wheel Drive Vehicles
- Prevents Damage to Lug Nut or New Stud
- Designed to Fit Studs Up to 14 mm or 9/16"



### 8 Piece Wheel Stud Alignment Guide Kit

SKU 818715 24233 **34<sup>99</sup>**

- Makes the Job Faster and Easier Allowing the Tech to Safely Position the Wheel Prior to Installing the Wheel Bolts
- Applications: Mercedes-Benz, BMW, Audi, VW, Porsche, Fiat and Dodge
- Sizes Included: 12 mm x 1.5, 12 mm x 1.25, 14 mm x 1.25, 14 mm x 1.75



OEM TOOLS

### Truck Wheel Stud Installer

SKU 339117 24235 **14<sup>99</sup>**

- Designed to Work on Truck Wheel Studs Up to 22 mm (7/8") in Diameter
- Use with an Impact Wrench or Ratchet



### Wheel Stud Installer Set for Cars and Trucks

SKU 1544687 24239

- Set Includes 24234 and 24235



**34<sup>99</sup>**

REG. \$39.98

**SAVE \$4 OVER**

When You Buy the Set

### 3.5" Digital Tire Inflator with Hose

SKU 1268419 AST3018 **114<sup>99</sup>**

- 21" Stainless Braided Hose
- Dual AAA Battery Powered Design
- Backlit LCD Digital Read-Out
- Includes Batteries



Astro

## Bead Seater

### 5 Gallon Bead Seater

SKU 526505 24449 **119<sup>99</sup>**

- Seats Beads on All Tires, from Small 4" Tires to 24-1/2" Truck Tires
- Operates on Standard Shop Air; Max. 120 psi



OEM TOOLS

# TIRE SERVICE

TO ORDER, contact your Commercial Sales Manager or go to [AutoZonePro.com](http://AutoZonePro.com)

TIRE SERVICE

Mount/Demount Heads	Fits	Models	OE Part Number		Fits	Models	OE Part Number
<b>Red Nylon Mount/Demount Head</b> SKU 1137811 SHA35034 <b>49<sup>99</sup></b> 	Hunter	TC250, TC300, TC325, TC350, TC2000, TC3250, TC3500, TC3000 and TC3100 Series	221-615-2-13	<b>Nylon Mount/Demount Head without Hardware</b> SKU 1125892 SHA35033 <b>44<sup>99</sup></b> 	Accuturn	3602, 3602HP, 4260, 4560MR, 4602, 5602 and 5602 HP	2002433, 14024784
	Accuturn	(Requires Adapter) 220A, All Other Models Require 102765 Adapter	SM102529		Hofmann	1520, 1565, 1620, 1625EM, 3300, 3300EM, 1270, 2300, 3000 and 3000GP	4024784, ST0024335
	Ranger	R980X Rev A Models, R980XR/NXT, R30XLT, RX-850/950-B Models, R23/23ST, R26ST/26EX, R745 and R710 Models ONLY. Require RAN5150524 Adapter	5150523		John Bean	EHP System IVE, IV, III, IIE	2433, EAA 0247G20A
<b>Nylon Mount/Demount Tapered Hole Head with Hardware</b> SKU 1137818 SHA38306 <b>40<sup>99</sup></b> 	Coats	5030, 5040, 5045, 5050, 5060, 5065, 6050, 6060, 6065, 7050, 7055, 7060, 7065, 7660, 7665, 50X, 60X, 70X, 80X, GTS, RC45, RC55, Maxx50, 70 and 80	8183061	<b>Nylon Mount/Demount Head with Round Hole Kit</b> SKU 1137815 SHA35030 <b>99<sup>99</sup></b> 	Snap On	All Models	2433, EAA 0247G20A
	Baseline	BL200, BL300, BL400 and BL500	8183061		All Tool	All Models	2008402
<b>Low Profile Mount/Demount Head</b> SKU 1125869 SHA35038 <b>64<sup>99</sup></b> 	Coats	Replacement for Coats 8184432. For use on Models RC100, RC150, RC200, 5030, 5035, 5040, 5045, 5050 Series, 5060 Series, 5065 Series, 6050, 6060, 6065, 7050, 7055, 7060, 7065, 7655, 7660, 7665, BL200, BL300, BL400 and BL500	8184432	<b>Nylon Mount/Demount Head</b> SKU 1125877 SHA35031 <b>39<sup>99</sup></b> 	Coats	Early 5060, Early 5060A, Early 5060E, Early 5060AX, Early 5060EX, 9010A, 9010E, 9024E, Some APX80, APX80A, APX80E, APX90, APX90A, APX90E, RC-1, RC1, RC-5A, RC5A, RC-15A, RC15A, RC-20AA, RC20AA	83008402, 83008403
	Accuturn	3602, 3602HP, 4260, 4560MR, 4602, 5602 and 5602 HP	2002433		CEMB	All Models	3008403, 2008402
<b>Nylon Mount/Demount Head with Hardware</b> SKU OSB TMRTC14024784 <b>54<sup>99</sup></b>  For OSB, Call 901-300-4878	Hofmann	1520, 1565, 1620, 1625EM, 3300, 3300EM, 1270, 2300, 3000 and 3000GP	4024784	Hofmann	12SE, 22SE, 1510, 1610, S410	8314813	
	John Bean	EHP System IVE, IV, III, IIE	24335	Hunter	Not for use on Hofmann: 1550, 1620 and 1625	RP11-8-11400327, RP11-8314813, 83008403	
	Snap On	All Models	24335	Giuliano, Corgi, SICE	Fits Many Hunter TCX series	Giuliano - 8314813 Corgi - 4-120129B SICE - 3008403	

## Rim Protectors

### 10 Pk. Quilted Clamp Sock for Rim Clamp Jaw

SKU OSB  
TMRTC183604 **39<sup>99</sup>**

- Replacement for Coats 8183604
- For Use with All Rim Clamp RC and TC Jaws Except 9010 and 9024E and Models with Grip Max Clamps



For OSB, Call 901-300-4878



### Hybrid Duckhead Tail - 2 Pack

SKU 1442586  
AMM8560896102 **44<sup>99</sup>**

- Designed to Float Across the Rim, Decreasing the Stretching of the Bead
- Compatible with Hybrid Duckhead® Mount/Demount Tool (85608959)
- Compatible with All X-Series and RC Series That Have Hybrid Duckhead® Mount/Demount Tools



**coats**

Prices subject to change without notice. Prices do not include applicable taxes, vehicles, tires, rims, installation or optional equipment as shown. Please do not return purchases to the store. For information regarding warranty, repair, or any questions or concerns, call 901-300-4878.

# TIRE SERVICE

## Non-Marring Lug Nut Sockets

OEM TOOLS®

### 1/2" Drive 17 mm Mercedes-Benz® Flower Lug Bolt Impact Socket

SKU 081308 **15<sup>99</sup>**  
24469

- Designed Specifically for 17 mm, Convex "Flower" Shaped Mercedes Lug Bolts



### 9 Piece Thin-Wall Wheel Protector Impact Socket Set

SKU 965856 **79<sup>99</sup>**  
24224

- Sizes: 3/4", 7/8", 13/16", 15/16", 1", 1-1/16", 17 mm, 19 mm and 21 mm



### 3 Piece Thin Wall Nut Protector Impact Socket Set

SKU 94646 **29<sup>99</sup>**  
25583

- Includes: 17 mm (11/16") Blue, 19 mm (3/4") Yellow, and 21 mm (13/16") Red
- Made of Chrome Moly Steel for Strength
- Designed to Protect High Polished Wheels and Lug Nuts from Damage
- Color Coded for Easy Identification

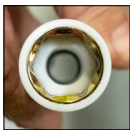

### 3 Piece Super Strength Wheel Nut Impact Socket Set

SKU 347212 **43<sup>99</sup>**  
24227

- Blue - 17 mm/11/16"
- Gold - 19 mm/3/4"
- Red - 21 mm/13/16"



## Lug Nut Sockets

OEM TOOLS®

### Master Lug Nut Kit

SKU 1190208  
68919

- Includes: 2 Socket Sets for Removing, Locking, Damaged and Undamaged Lug Nuts on Most Vehicles
- Ideal for Removal of Warped and Mangled Chrome-Cap Style Lug Nuts
- Easily Removes Locking Lug Nuts on Most Aftermarket Wheels



**109<sup>99</sup>**

REG. \$129.98

**SAVE OVER \$19**

When You Buy the Kit

### 16 Piece Locking Lug Master Key Set

SKU 626107 **89<sup>99</sup>**  
24447

- Easily Removes Locking Lug Nuts on Most Aftermarket Wheels
- Thin-Wall Sockets Prevent Damaging Wheels and Lugs
- Hex-Head Design Fits Most Lug Wrenches as well as 13/16" and 7/8" Sockets



### 4 Piece Deep Thin-Wall SAE and Metric Impact Flip Socket Set

SKU 965857 **30<sup>99</sup>**  
24223

- Includes: 3/4" to 13/16", 19 mm to 21 mm and 7/8" to 15/16" Sockets and 3" Extension



### 5 Piece 1/2" Drive Flip Socket Set

SKU 1125891 **33<sup>99</sup>**  
25555

#### Half Metric Sizes for Removal of Warped and Mangled Chrome-Cap Style Lug Nuts

- Durable CR-MO Flip Socket Set
- Includes: 18.5 mm x 19.5 mm, 19 mm x 21 mm, 21 mm x 21.5 mm, 22 mm x 22.5 mm and 1/2" Drive Extension



## Torque Limiting Sets

OEM TOOLS®

### 8 Piece Torque Limiting Extension and Thin Wall Socket Set

SKU 347217 **114<sup>99</sup>**  
24228

- 4 Extension Bars: 65 Ft/Lb. (90 Nm), 90 Ft/Lb. (120 Nm), 100 Ft/Lb. (135 Nm) and 110 Ft/Lb. (150 Nm)
- 4 Deep Sockets: 17 mm, 19 mm, 21 mm, 22 mm



### 5 Piece 1/2" Drive Torque Limiting Extension Set

SKU 965858 **89<sup>99</sup>**  
24220

- Quick, Simple and Accurate
- Helps Prevent Lug Stud/Nut Damage and Warped Rotors
- Includes 1/2" Drive Extensions: 65 Ft/Lb., 80 Ft/Lb., 100 Ft/Lb., 120 Ft/Lb. and 140 Ft/Lb.
- Made with Flexible Chromoly Steel that Stops Turning When the Required Torque is Reached
- Comes in a Sturdy Blow Mold Case



## Torque Wrenches

OEM TOOLS®

### 3/8" Drive (10-80 Ft/Lb.)

SKU 177722 **64<sup>99</sup>**  
25694

### 1/2" Drive (10-150 Ft/Lb.)

SKU 012651 **79<sup>99</sup>**  
25689

### 1/2" Drive (25-250 Ft/Lb.)

SKU 177715 **79<sup>99</sup>**  
25695



25695

### 1/2" Drive Undercar Torque Wrench

SKU OSB **329<sup>99</sup>**  
CEN97354A

- Unique One-Way Design Cannot Be Used as a Breaker Bar (thus Preventing Damage)
- High Contrast Laser Markings for Easier Reading
- Rubber Over-Mold Lock Ring for Better Grip
- Head and Handle Covers for Increased Durability
- Range: 25 to 250 Ft/Lb. (43.4 to 348.4 Nm)
- Length: 23.3"



For OSB, Call 901-300-4878

Central TOOLS, Inc.  
QUALITY AND INNOVATION SINCE 1988

# TIRE SERVICE

TO ORDER, contact your Commercial Sales Manager or go to [AutoZonePro.com](http://AutoZonePro.com)

TIRE SERVICE

## Tire Service Tools

**OEM TOOLS®**

### 2 Piece Tire Valve Core Tool Set

SKU 1209377 **9<sup>99</sup>**  
22589

- Designed for Removal and Installation of Schrader Style Valve Cores
- Includes: 2" and 5" Tools
- Extra-Long 5" Tool for Hard-to-Reach Applications
- Tough Impact and Solvent-Resistant Acetate Handle



### Tire Tube Test Tank

SKU 291382 **109<sup>99</sup>**  
LIS19822

- Tank Features Reinforcement Ribs for Extra Support
- Will Handle Passenger Tire Sizes to Wide Oval and Light Duty Truck Tires
- Dimensions: 31" (L) x 12" (W) x 12" (H)



**Lisle**

### 5025 Tire Spreader

SKU 757051 **449<sup>99</sup>**  
BRA00-0161

- Self-Locking Spread Arms
- 4 Horizontal and 2 Vertical Adjustments
- Handles Any Passenger Tire, Including Low Profiles
- Quick Pin Adjustment with Lanyard



**Branick**

### Tire Patch Stitcher 2 Pk.

SKU 1053946 **21<sup>99</sup>**  
XTS14-314PK

- Professional Quality Tire Repair Tool
- Stitches Down Patch to Remove Air Bubbles



**Xtra seal**

## Tire Repair

### Puncture Repair Set

SKU OSB **179<sup>99</sup>**  
XTS14-662

- Includes Puncture Repair Procedures Guide and 20" x 32" Shop Poster
- Enough Supplies to Provide More Than 70 Complete Repairs



**Xtra seal**

For OSB, Call 901-300-4878

### Tire Repair Cabinet Assortment

SKU OSB **649<sup>99</sup>**  
XTS14-603

- Deluxe Wall-Mount Cabinet
- Loaded to Complete Over 110 Industry Standard Puncture Repairs
- All the Tools Plus XLIGHT Air Powered Vacuum Carbide Cutters and More



**Xtra seal**

For OSB, Call 901-300-4878

### 11" Cotton Tire Swab (6 Pack)

SKU 666324 **21<sup>99</sup>**  
XTS14-378PK

- Professional Quality Tire Repair Tool
- Use to Spread Mount/Demount Lube on Bead of Tire



**Xtra seal**

### Mounting/Demounting Compound (2 Pack)

SKU OSB **49<sup>99</sup>**  
XTS14-708EPK

- Very Slippery
- No Mixing or Water Required
- Dries Tacky
- Rust Inhibitors Prevent Damage to Tire Bead
- Works Great with Low Pro, Run Flat and Alloy Wheel Applications



**Xtra seal**

For OSB, Call 901-300-4878

### Xtra Slick Tire Bead Lube (2 Pack)

SKU 1281603 **23<sup>99</sup>**  
XTS14-753PMPK

- Ready-to-Use Mounting and Demounting Compounds to Prevent Damage to Tire Bead
- Pre-Mixed



**Xtra seal**

### 8 Oz. Vulcanizing Cement (3 Pack)

SKU 666342 **24<sup>99</sup>**  
XTS14-008PK

- Fast Drying
- Can Be Used with Heat Vulcanization



**Xtra seal**

### 57 Piece Tire Repair Kit

SKU 213119 **43<sup>99</sup>**  
26686

- Includes: T-Handle Plug Insert Tool, T-Handle Reaming Tool, Replacement Insert Needle, Long Nose Pliers, Hex Keys, 30 Repair Plugs, Utility Knife, Lubricant, Valve Cores, Valve Caps, Valve Stems and a Valve Core Tool



**OEM TOOLS®**

### Refill Plugs for Any OEMTOOLS® Tire Repair Kit

**OEM TOOLS®**

#### Repair Plug Refill Sets

- For Use with 26680, 26682, 26683 and 26686



**30 Pack**  
SKU 477063  
26684 **9<sup>99</sup>**

**100 Pack**  
SKU 477176  
26685 **19<sup>99</sup>**

Prices subject to change without notice. Prices do not include applicable taxes, vehicles, tires, rims, installation or optional equipment as shown. Please do not return purchases to the store. For information regarding warranty, repair, or any questions or concerns, call 901-300-4878.

AZG0226

107

# TIRE SERVICE

## Wheel Weight Kits

- Steel Weights are More Environmentally Friendly Compared to the Lead Weight Alternative
- Premium Powder Coated Finish Resists Chips and Scratches Which Helps Prevent Damage and Corrosion to Wheels

### Complete Wheel Weight Kit with Floor Rack

SKU 1392466  
68953A

- Includes 78 Boxes of Coated Clip-On Wheel Weights
- ALFE, LHFE, MCFE, PFE, TFE, ENFE, FNFE and IWFE
- 25 Weights per Box
- All Metal Floor Rack

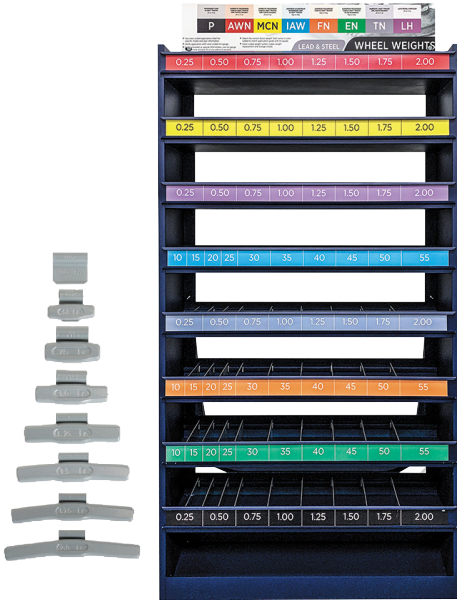

- ALFE Steel
- LHFE Steel
- MCFE Steel
- PFE Steel
- TFE Steel
- ENFE Steel
- FNFE Steel
- IWFE Steel

**999<sup>99</sup>**

REG. \$1,609.21

**SAVE OVER \$609**  
When You Buy the Kit

### Wheel Weight Starter Kit with Floor Rack

SKU 1339729  
OEMREPLENKITA

- Includes: 18 Boxes of Coated Clip-On Wheel Weights
- ALFE, MCFE and PFE in the Most Popular Sizes
- 25 Weights per Box
- All Metal Floor Rack

- ALFE Steel
- MCFE Steel
- PFE Steel

**549<sup>99</sup>**

REG. \$631.81

**SAVE OVER \$81**  
When You Buy the Kit

OEM TOOLS®

### Adhesive Wheel Weight Starter Kit with Stand

SKU 1392467  
68955A

- Includes: 4 Boxes and 2 Rolls of Adhesive Wheel Weights
- 3 Boxes of Strips, .25 Oz, .50 Oz. and 1.00 Oz.
- 1 Box of .25 Oz. Strips, Black
- (2) 10 Lb. Rolls of .25 Oz. and .50 Oz.
- Wheel Weight Dispenser Stand



**349<sup>99</sup>**

REG. \$511.93

**SAVE OVER \$161**  
When You Buy the Kit

## Wheel Weights Only

OEM TOOLS®

### Complete Wheel Weight Kit, Weights Only

SKU 1392468  
68954A

- Includes 78 Boxes of Coated Clip-On Wheel Weights
- ALFE, LHFE, MCFE, PFE, TFE, ENFE, FNFE and IWFE in the Most Popular Sizes
- 25 Weights per Box



- ALFE Steel
- LHFE Steel
- MCFE Steel
- PFE Steel
- ENFE Steel
- FNFE Steel
- IWFE Steel
- TFE Steel

**599<sup>99</sup>**

REG. \$1,209.22

**SAVE OVER \$609**  
When You Buy the Kit

### Wheel Weight Starter Kit, Weights Only

SKU 1392326  
68957

- Includes: 18 Boxes of Coated Clip-On Wheel Weights
- ALFE, MCFE and PFE in the Most Popular Sizes
- 25 Weights per Box



- ALFE Steel
- MCFE Steel
- PFE Steel

**149<sup>99</sup>**

REG. \$231.82

**SAVE OVER \$81**  
When You Buy the Kit

### Adhesive Wheel Weight Starter Kit

SKU 1525567  
68956

- Includes: 4 Boxes and 2 Rolls of Adhesive Wheel Weights
- 3 Boxes of Strips, .25 Oz, .50 Oz. and 1.00 Oz.
- 1 Box of .25 Oz. Strips, Black
- (2) 10 Lb. Rolls of .25 Oz. and .50 Oz.



**199<sup>99</sup>**

REG. \$361.94

**SAVE OVER \$161**  
When You Buy the Kit

**CALL YOUR COMMERCIAL SALES MANAGER TO ORDER YOUR WHEEL WEIGHTS TODAY**

## Wheel Weight Tools

### Adhesive Wheel Weight Removal/Cutting Tool

SKU 1362016  
25096 **27<sup>99</sup>**

- All-In-One Wheel Weight Tool for Removal Installation and Cutting with Precision
- Hammer End with Non-Marring Head Prevents Damage
- Sharp Cutting Edge to Trim Adhesive Wheel Weights
- Jaws Feature a Protected Surface for Non-Marring Removal of Adhesive Wheel Weights
- Anti-Slip Rubber Coated Handle



### Clip-On Wheel Weight Hammer Tool

SKU 217378  
25690 **18<sup>99</sup>**

- Installs, Removes, Trims and Tightens All Types of Clip-On Wheel Weights
- Features a Special Plastic Material on Hammer Head for Safe, Mar-Free Installation
- Coated Handles for Comfort Grip

OEM TOOLS®



### 4 Piece Plastic Scraper Set

SKU 900802  
25513 **10<sup>99</sup>**

- Will Not Scratch Paint
- Great for Wheel Weight Removal

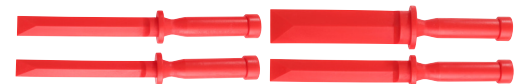

# TIRE SERVICE

TO ORDER, contact your Commercial Sales Manager or go to [AutoZonePro.com](http://AutoZonePro.com)

TIRE SERVICE

## Adhesive Weights



SKU	Part#	Size	Type	Description	Price
19304	23200*	.25 Oz.	40 Strips	12 Pieces per Strip, 480 Pieces per Box	<b>52.99</b>
19312	23201*	.25 Oz.	10 Lb. Roll	640 Pieces per Box	<b>63.99</b>
19294	23203*	.50 Oz.	24 Strips	10 Pieces per Strip, 240 Pieces per Box	<b>63.99</b>
19310	23202*	.50 Oz.	10 Lb. Roll	320 Pieces per Box	<b>74.99</b>
1339726	23214	1.00 Oz.	16 Strips	7 Pieces per Strip, 112 Pieces per Box	<b>67.99</b>
1339728	23216	.25 Oz.	30 Strips	Black, 8 Pieces per Strip, 240 Pieces per Box	<b>37.99</b>



Easy Peel Tape

STORE STOCKED\*

## Wheel Weight Racks



### Adhesive Wheel Weight Dispenser Stand

SKU 1363723  
23209 **149.99**

- Easy Assembly
- Can Be Secured to Workshop Floors
- Holds 2 Rolls
- All Metal Construction



Mounting Hardware and Wheel Weights Not Included

### Metal Wheel Weight Floor Rack

SKU 1328027  
PLM486-31280 **449.99**

- All Metal Construction
- 8 Shelves
- Includes Dividers



## Clip-On Wheel Weights

STORE STOCKED\*

- Easy to Apply and Remain Firmly in Place Once Installed
- Steel Weights are More Environmentally Friendly Compared to the Lead Weight Alternative

- Polymer Coated for the Best Appearance and Exceptional Corrosion Resistance
- 1 Box of 25 Each



SKU	Part #	Profile	Price
1359082	23246	10 gm. IWFE	<b>3.99</b>
1359087	23248	15 gm. IWFE	<b>5.99</b>
1359077	23271	20 gm. IWFE	<b>7.99</b>
1359098	23273	25 gm. IWFE	<b>9.99</b>
1359089	23277	30 gm. IWFE	<b>11.99</b>
1359075	23283	35 gm. IWFE	<b>13.99</b>
1359040	23290	40 gm. IWFE	<b>14.99</b>
1359084	23294	45 gm. IWFE	<b>16.99</b>
1359043	23297	50 gm. IWFE	<b>18.99</b>
1417848	23301	55 gm. IWFE	<b>20.99</b>
1414943	23310	60 gm. IWFE	<b>22.99</b>
382841	23217*	0.25 Oz. MCFE	<b>9.99</b>
382842	23219*	0.50 Oz. MCFE	<b>10.99</b>
382843	23220*	0.75 Oz. MCFE	<b>11.99</b>
382844	23221*	1.00 Oz. MCFE	<b>13.99</b>
382845	23227*	1.25 Oz. MCFE	<b>17.99</b>
382846	23230*	1.50 Oz. MCFE	<b>17.99</b>
1359096	23244	1.75 Oz. MCFE	<b>20.99</b>
1359053	23253	2.00 Oz. MCFE	<b>21.99</b>
1359056	23257	2.25 Oz. MCFE	<b>23.99</b>
1359052	23260	2.50 Oz. MCFE	<b>26.99</b>
1359095	23262	2.75 Oz. MCFE	<b>28.99</b>
1359036	23263	3.00 Oz. MCFE	<b>31.99</b>
382853	23218*	0.25 Oz. PFE	<b>6.99</b>
382919	23223*	0.50 Oz. PFE	<b>8.99</b>
382920	23224*	0.75 Oz. PFE	<b>8.99</b>
382921	23225*	1.00 Oz. PFE	<b>10.99</b>
382922	23226*	1.25 Oz. PFE	<b>12.99</b>
382923	23228*	1.50 Oz. PFE	<b>14.99</b>
382924	23229*	1.75 Oz. PFE	<b>15.99</b>
382925	23232*	2.00 Oz. PFE	<b>16.99</b>

SKU	Part #	Profile	Price
1359093	23235	2.25 Oz. PFE	<b>23.99</b>
1359086	23236	2.50 Oz. PFE	<b>26.99</b>
1359058	23237	2.75 Oz. PFE	<b>28.99</b>
1359069	23259	3.00 Oz. PFE	<b>31.99</b>
1359038	23239	10 gm. FNFE	<b>3.99</b>
1359073	23242	15 gm. FNFE	<b>5.99</b>
1359092	23265	20 gm. FNFE	<b>7.99</b>
1359068	23267	25 gm. FNFE	<b>9.99</b>
1359071	23269	30 gm. FNFE	<b>11.99</b>
1359063	23270	35 gm. FNFE	<b>13.99</b>
1359083	23272	40 gm. FNFE	<b>14.99</b>
1359057	23274	45 gm. FNFE	<b>16.99</b>
1359094	23275	50 gm. FNFE	<b>18.99</b>
1359070	23276	55 gm. FNFE	<b>20.99</b>
1417552	23309	60 gm. FNFE	<b>22.99</b>
383021	23222*	0.25 Oz. ALFE	<b>9.99</b>
383022	23231*	0.50 Oz. ALFE	<b>10.99</b>
383023	23233*	0.75 Oz. ALFE	<b>14.99</b>
383029	23234*	1.00 Oz. ALFE	<b>15.99</b>
1359044	23243	1.25 Oz. ALFE	<b>18.99</b>
1359078	23247	1.50 Oz. ALFE	<b>19.99</b>
1359076	23249	1.75 Oz. ALFE	<b>20.99</b>
1359037	23250	2.00 Oz. ALFE	<b>21.99</b>
1359048	23252	2.25 Oz. ALFE	<b>23.99</b>
1359074	23287	2.50 Oz. ALFE	<b>26.99</b>
1359047	23289	2.75 Oz. ALFE	<b>28.99</b>
1417555	23302	3.0 Oz. ALFE	<b>31.99</b>
1359054	23238	0.25 Oz. TFE	<b>9.99</b>
1359064	23241	0.50 Oz. TFE	<b>10.99</b>
1359091	23255	0.75 Oz. TFE	<b>12.99</b>
1359049	23256	1.00 Oz. TFE	<b>14.99</b>

SKU	Part #	Profile	Price
1359039	23258	1.25 Oz. TFE	<b>18.99</b>
1359088	23261	1.50 Oz. TFE	<b>19.99</b>
1359080	23264	1.75 Oz. TFE	<b>20.99</b>
1359059	23266	2.00 Oz. TFE	<b>21.99</b>
1359060	23268	2.25 Oz. TFE	<b>23.99</b>
1359079	23284	2.50 Oz. TFE	<b>26.99</b>
1359066	23286	2.75 Oz. TFE	<b>28.99</b>
1359062	23288	3.00 Oz. TFE	<b>31.99</b>
1359097	23251	10 gm. ENFE	<b>3.99</b>
1359067	23254	15 gm. ENFE	<b>5.99</b>
1359081	23278	20 gm. ENFE	<b>7.99</b>
1359051	23279	25 gm. ENFE	<b>9.99</b>
1359045	23280	30 gm. ENFE	<b>11.99</b>
1359090	23282	35 gm. ENFE	<b>13.99</b>
1359061	23293	40 gm. ENFE	<b>14.99</b>
1359050	23296	45 gm. ENFE	<b>16.99</b>
1414944	23299	50 gm. ENFE	<b>18.99</b>
1414942	23300	55 gm. ENFE	<b>20.99</b>
1414945	23308	60 gm. ENFE	<b>22.99</b>
1359055	23240	0.25 Oz. LHFE	<b>9.99</b>
1359085	23245	0.50 Oz. LHFE	<b>10.99</b>
1359042	23281	0.75 Oz. LHFE	<b>12.99</b>
1359072	23285	1.00 Oz. LHFE	<b>14.99</b>
1359065	23291	1.25 Oz. LHFE	<b>18.99</b>
1359041	23292	1.50 Oz. LHFE	<b>19.99</b>
1359046	23295	1.75 Oz. LHFE	<b>20.99</b>
1414947	23298	2.00 Oz. LHFE	<b>21.99</b>
1414946	23303	2.25 Oz. LHFE	<b>23.99</b>
1417553	23304	2.50 Oz. LHFE	<b>26.99</b>
1417556	23305	2.75 Oz. LHFE	<b>28.99</b>
1417554	23306	3.00 Oz. LHFE	<b>31.99</b>

Wheel Weight Profile

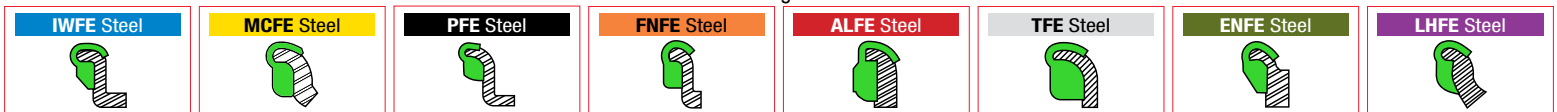

Prices subject to change without notice. Prices do not include applicable taxes, vehicles, tires, rims, installation or optional equipment as shown. Please do not return purchases to the store. For information regarding warranty, repair, or any questions or concerns, call 901-300-4878.

# BRAKE SERVICE

FOR HELP with Selection, Confirm Availability and Ordering Instructions, Call 901-300-4878

## Brake Lathe Kit

**PRO-CUT**  
BRAKE SOLUTIONS

### Combination Bench Lathe Kit

SKU OSB  
PCTB-17K **13,449<sup>99</sup>**

- Features Adapters and Accessories for All Passenger Vehicles and Light Trucks
- Resurfaces Brake Drums and Discs to Exceed OEM Specs for Surface Finish in 1 Pass
- Switch from Drums to Rotors in Seconds
- Includes: Dust Collection System and Side Work Table

On-Site Installation and Training Included

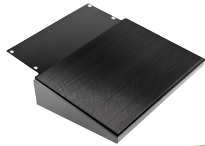

PCT50-4720



PCT50-4280



PCTB-17

WARRANTY: 2 Years Parts and Labor

**BONUS VALUE: \$1,749.99**

### Quick Chuck Kit

PCT50-4250K

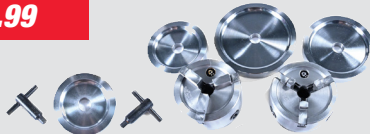

With Purchase of PCTB-17K

Offer Good While Supplies Last Through June 30, 2026

## Lathe Package with Trolley

**PRO-CUT**  
BRAKE SOLUTIONS

### On Car Brake Lathe for Car and Light Truck

SKU OSB  
PCTX15-6ADP **18,249<sup>99</sup>**

- Plug In, Variable Speed 48v DC Motor
- Performance Plus Cutting Head
- PFM 2.0 Electronics
- Patented One Touch Lateral Run Out (LRO) Compensation
- Cross Platform Compatible Computer and Wiring Harness
- 6 LED On-Board Work Light
- 4 Wheel, 4 Axis, Adjustable Trolley

On-Site Installation and Training Included

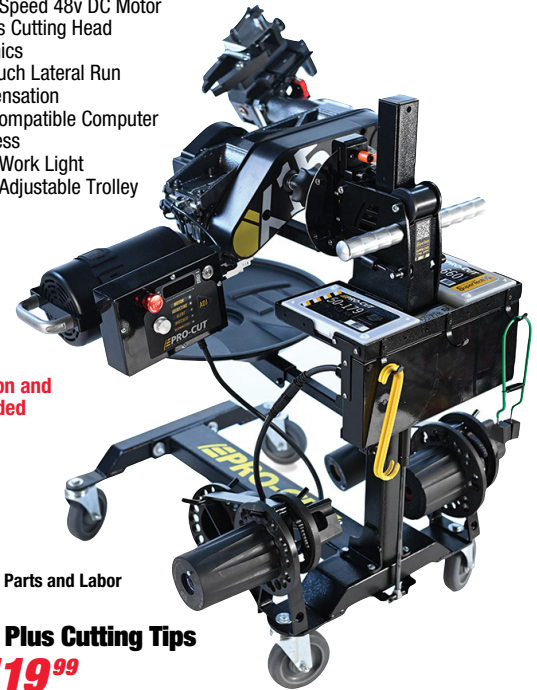

WARRANTY: 2 Years Parts and Labor

### Performance Plus Cutting Tips

SKU OSB  
PCT50-778 **119<sup>99</sup>**

- Includes: 6 Tips with Screws

**TEST DRIVE BEFORE YOU PURCHASE!**

**901-300-4878**

## Ranger®

### RL-8500 Combination Brake Lathe with Bench and Standard Tooling

SKU OSB  
RANRL8500 **10,799<sup>99</sup>**

- Complete Kit Includes: Lathe, Standard Adapters and Bench
- Provides a Faster, More Accurate and Easier Resurfacing Capability Than Any Other Brake Lathe in Its Class
- Infinitely Variable Speed Controller Able to Turn Rotors and Drums
- Quick-Change Adapter-Plus System with Built-In Springs Eliminates the Need for Conventional Bell Clamps and Cones
- Independent DC Servo Motors Control the Cross-Feed and Spindle-Feed Drives
- One-Cut Micro Finish
- 150 or 200 RPM Spindle

### RL-8500XLT HD Combination Brake Lathe with Bench and Standard Tooling

SKU OSB  
RANRL8500XLT **12,499<sup>99</sup>**

WARRANTY: 1 Year Parts and Labor

Leasing Terms Available, Ask Your AutoZone® Commercial Sales Manager.



RANRL8500

Shown with Optional Equipment. Accessories Not Included.

**Ranger**

### Truck Adapter Package

SKU OSB  
RAN5150161 **2,599<sup>99</sup>**

- Super-Duty Truck Tooling Package Consists of an Upgraded 1-7/8" Arbor and a Wide Variety of Adapters
- 32 Piece Set Allows Expanded Coverage to Handle Any Vehicle Up to 1 Ton Trucks
- Fits RL-8500 and RL-8500XLT



Customer Responsible For Offloading, Liftgate Service Available.

For OSB, Call 901-300-4878

# BRAKE SERVICE

TO ORDER, contact your Commercial Sales Manager or go to [AutoZonePro.com](http://AutoZonePro.com)

BRAKE SERVICE

## Brake Service Tools

### 2 Piece Steel Line Stopper Set

SKU 1331483 **17<sup>99</sup>**  
35057

- Seals Steel Lines Found on Fuel, Brake, AC, Power Steering, Transmission Cooling Lines and Banjo Lines
- Prevents Leaks and Contamination
- For Use with All Automotive Fluids
- Fits 3/8", 1/2", 5/16" and Banjo Lines



### Power Steering Bleeder Set

SKU 434716 **29<sup>99</sup>**  
27311

- Eliminate Trapped Air in Power Steering and Brake Systems Following Repairs or Fluid Changes
- Works with a Hand Vacuum Pump That Can Be Coupled to the Adapter
- Includes: 2 Tapered Rubber Adapters to Fit Most Power Steering Pumps and Reservoirs



### 8 Piece Brake Tool Set

SKU 900827 **41<sup>99</sup>**  
27194

- Includes: Spring Compressor, Brake Spring Installer, Spring Removal Tool, Brake Retaining Spring Tool, Brake Spring Pliers, 2 Brake Adjustment Spoons and Mini Adjustment Spoon

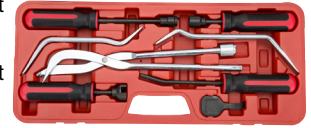

### Brake Cylinder Retainer Remover

SKU 265111 **17<sup>99</sup>**  
25268

- Expands and Holds Special Retainer So the Brake Cylinder May Be Removed
- Releases the Spring Clip Retainer That Attaches the Rear Brake Cylinder to Backing Plate

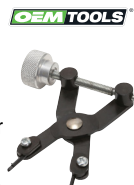

### 8 Piece Brake Caliper Hanger Set

SKU 312538 **34<sup>99</sup>**  
24518

- Prevents Kinking or Premature Failure of Brake Hose
- Keeps Calipers Up and Out of the Way When Servicing Suspension Components, Brakes, etc.
- Hi-Vis Green Powder Coat So You Won't Misplace Them or Leave Them Attached to the Vehicle



### 8 Piece Manual Brake Gauge Set

SKU 191672 **19<sup>99</sup>**  
25266

- Color Coded Brake Gauge Identifies Thickness Levels for Brake Lining Inspection
- Includes Sizes: Red: 2, 3 mm, Yellow: 4, 5, 6 mm, Green: 8, 10, 12 mm
- Red Indicates Must Be Serviced; Yellow Indicates Should Be Serviced; Green Indicates Good

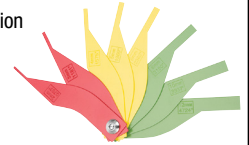

### Brake Caliper Brush

SKU 250125 **21<sup>99</sup>**  
25435

- Slim Design for Cleaning Brake Calipers and Other Brake Hardware



### Multi-Purpose Tubing Bender

SKU 390889 **15<sup>99</sup>**  
25179

- Lightweight for Easy Handling
- Makes Left, Right and Offset Bends Up to 90°
- Degrees Marked for Accuracy
- Use with 1/4", 5/16" and 3/8" (4, 6 and 8 mm) Diameter of Mild Steel and Soft Tube Material



### Disc Brake Pad Spreader

SKU OSB **16<sup>99</sup>**  
25265

- For Use on Domestic and Import Cars and Light Trucks
  - Made from High Carbon Steel and Chrome Vanadium Steel to Resist Corrosion
- For OSB, Call 901-300-4878



### Rotor/Drum Caliper Kit

SKU 186504 **124<sup>99</sup>**  
CEN3K301

- Attaches to Any Caliper on the Lower Jaws
- Outward Facing Anvils to Inspect Drums
- Inward Pointing Anvils to Measure Rotors 8" to 13"
- Range 0 to 6" Digital Caliper Included



### Electronic Digital Rotor Gage

SKU OSB **117<sup>99</sup>**  
CEN3M431

- Easy-to-See Digital Readout
- Long Arms for All Rotors
- Interchangeable Flat and Pointed Anvils

For OSB, Call 901-300-4878



### Disc Brake Rotor Micrometer

SKU 607071 **99<sup>99</sup>**  
25367

- .001" Accuracy, .0005" Reading
- Large LCD Display with SAE or Metric Reading
- Manual Power Off/On
- Range: 5.5"/140 mm
- Easy Glide Action
- Hardened Measurement Surface



## Carbide Lathe Inserts



SKU	Part Number	Quantity	Application	Description	OEM Part No.	Price
262385	SHA0626	6 Pack	Ammco	Use on Ammco Models 1000, 1001, 3000, 4000, 4100, 7000, 7700	90614-6	<b>37.99</b>
262386	SHA06210	10 Pack	Ammco	Use on Ammco Models 1000, 1001, 3000, 4000, 4100, 7000, 7700	90614-10	<b>34.99</b>
262388	SHA1046	6 Pack	Ammco	Positive Rake Cutting Bits for Ammco Models 3850, 4000, 7000 and 7500 as well as Twin Cutter and 9381 Facing Set	906918-6	<b>75.99</b>
543384	SHA069-10	10 Pack	Pro-Cut	Pro-Cut Style Bit for Use on Model 610 On-The-Car Lathes for Ford. RJ West PFM 9.2, FM900, PFM 9.2DRO Warthog and 9.2DRO	50-742	<b>124.99</b>
262382	SHA40710	10 Pack	FMC	Use on FMC, John Bean, Barrett, Snap-On 67BSD, 67DLX, 67GSA, 69DLX, 701ECF, 601PF, 400, 500, 600, 700 Disc/Drum Lathes	90488, W139, D139	<b>98.99</b>
300786	SHA408-10	10 Pack	FMC/Ranger/Accu-turn	Ranger RL8500 and RL8500XLT Disc and Drum Cutting Lathes. FMC/Barrett Models 400, 500, 600 and 700 Lathes	45016	<b>114.99</b>
262383	SHA06010	10 Pack	Accu-turn	Use on Models: 7700, 8920, 8922, 8944, 8989, 8990, 8991, 8993, 8995 and 8997 Brake Lathes. 3 Cutting Edges	433796	<b>110.99</b>
1142331	SHA065-10	10 Pack	Hunter	Use on Rotor Models: BL500, 501 and 505 Hunter Lathes	221-639-3	<b>149.99</b>

## Silencer Bands



### Large Solid Rotor Silencer Band (9")

SKU 262396 **14<sup>99</sup>**  
SHA94



### Small Solid Rotor Silencer Band (6")

SKU 262393 **14<sup>99</sup>**  
SHA96



### Silencer Clamp

SKU 388821 **65<sup>99</sup>**  
SHA70B



### Ammco Style Disc Silencer Band with Steel Weights

SKU 262392 **44<sup>99</sup>**  
SHA69



### Ammco Style 1-3/4" Drum Silencer Band

SKU 262390 **69<sup>99</sup>**  
SHA80B

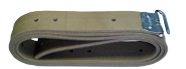

See [AutoZonePro.com](http://AutoZonePro.com) for More Applications

Prices subject to change without notice. Prices do not include applicable taxes, vehicles, tires, rims, installation or optional equipment as shown. Please do not return purchases to the store. For information regarding warranty, repair, or any questions or concerns, call 901-300-4878.

AZG0226

111

# BRAKE SERVICE

## Brake Bleeding Tools

OEM TOOLS

### Vacuum Pump Tester, Power Steering and Brake Bleeder Kit

SKU 1103570 **69<sup>99</sup>**  
37070

- Includes: Vacuum Pump Reservoir Jar with Transfer Lid, Storage Lid, Brake Bleeding Adapter Package, Steering Pump Adapters and Tubing Pump with Vacuum Gauge and Accessories



### 1 Liter Pneumatic Vacuum Brake Bleeder with Refill Bottle

SKU 1282750 **54<sup>99</sup>**  
22505 REG. \$64.99

SAVE \$10

- Convenient Single-Person Operation
- Effective for Use on Disc/ Drum Brakes and Clutches
- Auto-Refill Kit to Simplify the Master Cylinder Refill
- Uses a Standard Workshop Air Supply



Offer Good Through June 30, 2026

### Universal Fluid Dispensing Bottle

SKU 568477 **49<sup>99</sup>**  
24443

- Refill the Master Cylinder During Vacuum or Manual Hydraulic Brake or Clutch Bleeding and Flushing
- Mounts Securely to Master Cylinder and Clamps
- Capacity: 50 Oz.



### 2 Liter Pneumatic Vacuum Brake Bleeder with Refill Bottle

SKU 1361989 **99<sup>99</sup>**  
22506

- For Use on Brakes and Hydraulic Clutches
- Convenient Single-Person Operation
- Uses Standard Workshop Air Supply
- Includes: Auto-Refill Kit to Simplify the Master Cylinder Refill and Adapters to Fit Most US and Domestic Vehicles
- Standard and ABS Brake Systems



### Brake Bleeder, Steering Pump Bleeder and Vacuum Pump Test Kit

SKU 1142597 **64<sup>99</sup>**  
27070

- Kit Bleeds Brakes, Clutches and Other Hydraulic Systems
- Includes: Vacuum Pump Reservoir Jar with Transfer Lid, Storage Lid, Brake Bleeding Adapter Package, Steering Pump Adapters and Tubing



### Master Cylinder Adapter Cap Update Kit

SKU 1544667 **279<sup>99</sup>**  
MITMVA6855

- Includes: 2 Honda Caps, 1 Tesla Cap, 1 Nissan/Infiniti Hybrid Cap, 2 Ford Caps, 1 Ford/Tesla Cap, and 3 Down Tubes for Caps
- For Both EV and Hybrid Vehicles
- Update Kit Combined with MVA6850 Covers Most Hybrid and Electric Vehicle Brake Pressure Bleeding Applications
- Expands Our Cap Offerings for Brake Bleeding
- Can Be Used with All MityVac Manual and Pneumatic Pressure Pumps



### DIY Reverse Brake and Clutch Bleeder

SKU 459112 **64<sup>99</sup>**  
PHO2104-B

- Easily Bleeds ABS
- Removes Trapped Air
- Attachments to Fit All Vehicles



### 5 Piece Brake Bleeder Wrench Set

SKU 1442597 **53<sup>99</sup>**  
VIMBB500

- Sizes: 7 mm to 11 mm
- True Size Hex Openings for Tight Fit
- Satin Chrome Plated High Alloy Steel
- Angles are Designed to Access Bleeder Screws without Removing the Wheel



### Brake Bleeding Kit

SKU 604208 **249<sup>99</sup>**  
MITMV6830

- Compressed Air Operation
- 1.9 Quart Capacity
- Swivel Air Inlet with Quick Disconnect



### Pressure Brake Bleeding System

SKU 383099 **544<sup>99</sup>**  
MITMV6840

- Large 1.2 Gallon Capacity Dispenser
- Includes: 7 Master Cylinder Adapters That Connect to Most U.S., Asian and European Cars and Light Trucks
- Pressure Gauge Indicates Dispensing Pressure
- Utilizes Push-to-Connect, Quick-Change Adapters
- Integrated Manual Relief Valve for Safety



### 2.5 L Pressure Brake Bleed Kit

SKU 1361996 **584<sup>99</sup>**  
MITMV7840

- Utilizes Shop-Air to Produce Pressure for Dispensing and Vacuum for Extracting
- Pressure Control System Safely Maintains Output Pressure Between 20 and 25 psi
- Includes: 7 Master Cylinder Adapters That Connect to Most Domestic and Import Cars and Light Trucks
- Conveniently Located On/Off and Flow Control Valve



### Silverline Elite Test Kit

SKU 988888 **144<sup>99</sup>**  
MITMV8500

- Provides Either Vacuum or Pressure with Equal Precision and Convenience
- Performs Engine Performance Diagnostics, Brake Bleeding, Fluid Transfer, Evacuation, Sampling and More
- Includes: Components Needed to Perform Hundreds of Diagnostic and Mechanical Tests



## Disc Brake Tools

### 18 Piece Disc Brake Caliper Set

SKU 94798 **59<sup>99</sup>**  
27113

- Includes: Caliper Adapters from 1-3/16" to 2-1/2" – Some Specifically to Service Nissan, Saab and Honda Models
- Includes: Right and Left Hand Caliper Rotation Tools
- Left Hand Thread is Useful When Working on 2004-2007 Ford Freestyle, 500, 2008 Taurus and Taurus X Models
- Rust Resistant Finish



### 37 Piece Disc Brake Service Kit

SKU 1125858  
25107

- Includes: Disc Brake Caliper Tool Set, Pad Spreader, Brake Caliper Brush, 8 Brake Caliper Hangers, 3 Bleeder Wrenches and One-Man Brake Bleeder Kit



**69<sup>99</sup>**  
REG. \$125.28

SAVE OVER **\$55**  
When You Buy the Kit

### Pneumatic Brake Caliper Tool Set

SKU 1053954 **254<sup>99</sup>**  
MSC43050

- Durable Non-Impact Single Piston Shaft
- O-Ring Protected Shaft to Maintain Proper Pressure
- Magnetic Base to Secure Press Adapters
- 15 Piece Press Adapter Set



### Dual Piston Press

SKU 900811 **49<sup>99</sup>**  
25741

- Designed to Press-In Single and Dual Piston Brake Calipers
- Universal Application on Cars, Light and Heavy Trucks
- Rugged Design for Longer Tool Life



### Dual Speedy Pad Spreader

SKU 291420 **84<sup>99</sup>**  
LIS25750

- Compresses Dual Brake Pistons Simultaneously
- Makes Dual Piston Pad Replacement a Simple Job



### Speedy Pad Spreader

SKU 291417 **64<sup>99</sup>**  
LIS24300

- Compresses Disc Brake Pistons in Seconds
- Makes Brake Pad Replacement Easier



### Quick Quad Pad Spreader

SKU 080553 **109<sup>99</sup>**  
LIS29100

- A Quick Way to Spread Brake Pads and Compress Disc Brake Pistons for Pad Replacement on Single, Double and Quad Piston Calipers
- Simultaneously Compress All 4 Pistons on Quad Piston Applications
- Can Be Used While Caliper is on the Vehicle or Hanging Free



### Brake Caliper Press (Standard Size)

SKU 954224 **99<sup>99</sup>**  
LNG279

- Size Range: 1.7" to 3"
- Works on Various Single, Dual and Quad Piston Calipers
- 360° Ratchet Swing Allows Access at Any Angle



### Brake Caliper Press (Small Size)

SKU 1400043 **89<sup>99</sup>**  
LNG277

- Size Range: 1" to 2.25"

### Brake Caliper Piston Rewind Tool

SKU 1368620 **49<sup>99</sup>**  
35058

- Includes: Standard Two-Pin Adapter Compatible with Any Piston Adapter and a Fully Adjustable 3/8" Drive 2 and 3 Pin Adapter Tool That Fits Most Vehicles
- Powerful Internal Spring to Apply Stable Pressure to the Caliper Piston



### Brake Hub Resurfacing Tool

SKU 013590 **16<sup>99</sup>**  
24686

- Quickly Remove Rust on Lug Studs and Rotors on the Hub Assembly
- Use with Drill for a Quick and Easy Job
- Fits All Passenger Cars, Light Trucks and SUVs
- Includes: 4 Pads



### 2 and 3 Pin Brake Rewind Tool

SKU 13592 **24<sup>99</sup>**  
24693

- 2 Fully Adjustable to Fit Thousands of Vehicles
- No Need for Multiple Tools
- 3/8" Drive Adapters



3 Pin Side



2 Pin Side



# BRAKE SERVICE

## Sprayers

### Red Powder Coated Aluminum Sprayer

SKU 186463  
MSMB8000PL **46<sup>99</sup>**

- 16 Oz. Capacity
- Not for Use with Chlorinated Solvents
- Pressurize Up to 200 psi

### Complete Repair Kit for B8000PL

SKU 186467  
MSMBK50 **29<sup>99</sup>**



### Red Powder Coated Steel Sprayer

SKU 186459  
MSMA1000R **79<sup>99</sup>**

- 32 Oz. Capacity
- Not for Use with Water-Based Products
- Pressurize Up to 200 psi



### Repair Kit

SKU 186465  
MSMK10 **26<sup>99</sup>**

- Used for MSMA1000R
- Includes All Parts That Can Be Replaced
- All Chemical Resistant Seals



### Filler Cap Assembly

SKU 186466  
MSMP156 **26<sup>99</sup>**

- For Model "A" Sprayers
- Hand Removable

## Hones and Stones

### Rotor Flex-Hone®

**64<sup>99</sup>** each

- Lowers Harmonic Vibrations
- Ideal for New and Resurfaced Rotors and Flywheels

#### Fine

SKU 341310  
BRMRMFH240Z25

#### Medium

SKU 341298  
BRMRMFH120Z25

#### Coarse

SKU 341314  
BRMRMFH60Z25



### Flex-Hone BC 1" (25.4 mm)

SKU 341000  
BRMBC10018 **29<sup>99</sup>**

- 1" (25.4 mm) 180 Grit



### Adjustable Disc Brake or Small Engine Hone

SKU 531707  
25030 **12<sup>99</sup>**

- Includes: 3 Medium (220) Grit 3/4" Stones



## Brake Fluid Testers

### Brake Strip + 100 Ct. Coolant Strip Double Ended with Customer Cards

SKU 1089037  
PHO3006-PLUS **89<sup>99</sup>**

- Double Ended Test Strips for Brake Fluid and Coolant
- Use on DOT 3 or 4 Brake Fluid
- Compatible with All Coolant Colors
- Includes: 100 Double Ended Strips and 100 Rating Scale Cards



### Double Ended Brake Fluid + Coolant Test Strips, 100 Ct.

SKU 666577  
PHO3001-PLUS **84<sup>99</sup>**



### BrakeStrip Brake Fluid Copper Test Kit

SKU 289905  
PHO3006 **79<sup>99</sup>**

- Everything Needed to Test Brake Fluid
- Know within 60 Seconds if it's Time for a Change
- Includes: 1 Tube of 100 Test Strips and 100 Color Pop Rating Cards



### Brake Fluid Tester - DOT 3, DOT 4, DOT 5.1

SKU 850067  
25269 **34<sup>99</sup>**

#### Built-In LED Light to Ensure Tips are in Proper Contact with Fluid

- Easily, Quickly and Precisely Checks the Water Content of 8 Types of Polyglycol-Based Brake Fluids (DOT 3, DOT 4, DOT 5.1, ACDelco DOT 3, Pennzoil, Prestone, Motorcraft and Toyota DOT 3)



### Electronic Brake Fluid Tester

SKU 191687  
25267 **29<sup>99</sup>**

- Checks Moisture Content in Any Brake Fluid
- Multi-Colored LED Panel for Easy Recognition
- Automatic Shut-Off
- Calibrated for DOT 4 Fluid
- Includes: (1) AAA Battery



## Fluid Exchanger

### Premium Brake Fluid Exchange System

SKU 1407509  
MVC500-8100

**4,249<sup>99</sup>**

- Includes: Brake Adapter Kit
- Pressure and Vacuum Assist
- Portable, Operates on 12 Volt DC
- Complete Brake System Exchange in 10 Minutes
- Adjustable Pressure Regulator Controls Operating Pressure
- Performs Brake Flush Using Pressure and Vacuum Simultaneously



## Brake Service Tool

### Heavy Duty Hub Drum and Rotor Puller Kit

SKU 1125878  
25106 **159<sup>99</sup>**

#### Use with Impact Wrench to Remove Hubs, Drums and Brake Rotors

- Includes: 3 Hub Adapters for Use with Most Common Hub Sizes and Types
- Jaw Spread Up to 12-3/4" with 5" Reach
- Durable Forged Frame Rated to 7 Tons of Pulling Force for the Toughest Jobs
- Drum and Rotor Pulling Arms Feature with Raised Stops for Use with Ratchet Straps (Not Included)
- Easily Adjusts the Arms and Set Puller in Place for Tough Pulling Jobs in Tight Spaces
- Comes in Sturdy Blow Mold Case



## Scan Tools **TEXA Diagnostic Kits**

- World Class US-Based Support, with the Most Complete Vehicle Coverage
- Lifetime Repair or Replacement Equipment Warranty with Current Software Subscription
- Continual Updates on All Makes and Models with Current Software Subscription

- Fast, Powerful Hardware for Maximum Shop Efficiency
- Wiring Diagrams, Repair Procedures, Dashboards, Advanced Resets, Activations and More



### Axone Light Truck Diagnostic Kit

SKU OSB  
TEXAXLTHDTRK **4,999<sup>99</sup>**

- Advanced Diagnostics and OE-Level Coverage for Heavy-Duty Truck, Trailer, and Light Commercial Vehicles
- Includes: AXONE NEMO LIGHT, Suitable for a Large Range Of Environments and the TXT Multihub



### Axone Plus Truck Diagnostic Kit

SKU OSB  
TEXAXPLHTRK **7,499<sup>99</sup>**

- Advanced Diagnostics and OE-Level Coverage for Heavy-Duty Truck, Trailer, and Light Commercial Vehicles
- Includes: AXONE NEMO PLUS, Suitable for a Large Range Of Environments and the TXT Multihub



### Axone Plus Master Fleet Package for Truck/OHW/Car

SKU OSB  
TEXAXPLMFP **11,999<sup>99</sup>**

- Provides Advanced Diagnostics and OE-Level Coverage for Diverse Fleets Including Car, Truck, Agriculture and Construction Equipment
- Includes: AXONE NEMO PLUS, Suitable for a Large Range Of Environments, the TXT Multihub and the Off-Highway Essential Cable Case



For OSB, Call 901-300-4878

## Smoke Leak Detector



### Dual Evap Smoke Machine\*

SKU OSB  
MSC43065 **1,579<sup>99</sup>**

- For Evap, Turbo/Intake and Heavy Duty Truck Testing\*
- For Evap and High Pressure Diagnostic Testing
- Multiple Options for Smoke Injection Include Built-In Internal Compressor, Shop Air and Inert Gases
- Accessories Include: Smoke Hose, Block Off Caps, Exhaust Cone, Schrader Valve Remove/Installer, Evap Service Port Adapter Hose, Smoke Illuminating Flashlight, Smoke Producing Fluid and Bladder



\* Heavy Duty Truck Testing Requires MSC43062 Adapter Kit, Not Included (Sold Separately)

## Cooling System



### Heavy Duty Cooling Kit

SKU 954231  
MSC43306 **514<sup>99</sup>**

- For Use with Freightliner, International, Kenworth, Peterbilt, Mack, Volvo, GMC and Sterling Cooling Systems
- Uses Shop Air to Pressure Check and Vacuum Refill
- 4 Quick-Disconnect Vacuum Attachments Provide Quick Refilling of the Cooling System and Eradicates Airlocks
- Includes: Heavy Duty Vehicle Adapters, Pressure Test Regulator, Vacuum Refill Attachment with Tubing in a Plastic Case



## Recovery Machine



### Fully-Automatic Heavy Duty R134a Refrigerant Management System

SKU 1407805  
CPSMXHD **7,999<sup>99</sup>**

- For Commercial and Heavy Duty Applications
- 6 CFM Dual-Stage Vacuum Pump
- Large 12.67 CC Twin-Piston Oilless Compressor
- Comes Standard with a 50 Lb. Tank; Upgradeable to 90 Lb.
- Wi-Fi and Bluetooth Enabled



## Specialty Tools

### NAVISTAR® MAXXFORCE® Fuel Line Disconnect Tool Set - 4 Piece

SKU 004112  
25031 **41<sup>99</sup>**

- For Series 11 and 13 Engines
- Sized to Depress Fuel Release Tabs for Efficient Fuel Line Removal
- 1 Straight and (1) 90° Tool for 11.8 mm Fuel Lines; 1 Straight and (1) 90° Tool for 16 mm Fuel Lines



### Heavy Duty U-Joint Puller

SKU 041474  
24538 **134<sup>99</sup>**

- Easily Removes Seized U-Joint Cups on Most Class 7 and 8 Trucks
- Safely Disassemble Drivelines without Hammering or Heating Components
- Does Not Damage the Driveshaft, Yokes, Joints or Bearing Cups
- Bearing Cup Outside Diameter: 1.5" to 2.2"



### Automatic Slack Adjuster Release Tool and Wrench

SKU 1207889  
25252 **34<sup>99</sup>**

- 5/16" Double Square Ratchet Has an Angled Head to Give Extra Clearance for Hands
- Side-Mounted Forward/Reverse Lever for Easy Operation
- Speeds Up Installation on Meritor® Heavy Duty Truck Brake Slack Adjusters to Simplify Brake Service



### Brake Anchor Pin Press



SKU 1361998  
27090 **175<sup>99</sup>**

- For Removal of Brake Anchor Pins and Bushings on 16-1/2" S-Cam Trailer and Tractor Q Brake Systems
- No Need to Remove the Hub or Dust Shield
- Rigid C-Frame with 10 Ton Capacity
- Manufactured from High Grade Steel for Strength and Durability
- Manual, No Hydraulics Required



# HEAVY DUTY

## Heavy Duty Wheel and Tire Service

### Heavy Duty Truck Tire Changer

SKU **OSB**  
**ROTR501PLUS 26,749<sup>99</sup>**

- Dismount and Mount a Truck Tire in 30 Seconds
- Super Fast Truck Tire Changer
- Adjustable Arm Position
- Max. Tire Diameter: 52"
- Quick Loading

**INCLUDES:** Set Up and Training

**WARRANTY:** 3 Years Parts and Labor



### R544 Plus Pro Truck 3D Wheel Balancer

SKU **OSB**  
**ROTR544P 15,739<sup>99</sup>**

- Wheel Diameter: 10" to 30"
- Tire Width: 1.5" to 22"
- Maximum Tire Diameter: 51"
- Passenger/LT Truck/HD Capable with Standard Adapters
- Max. Rim Diameter: 30"
- Max. Tire Diameter: 51"

**INCLUDES:** Set Up and Training

**WARRANTY:** 3 Years Parts and Labor



### Coats® CHD-6330 Heavy Duty Tire Changer

SKU **OSB**  
**AMM8006330 23,049<sup>99</sup>**

- Motor: 2 HP
- Max. Tire Diameter: 63"
- Rim Diameter: 13" to 27"
- 4-Jaw Chuck Allows for Fast and Easy Clamping of Virtually All Rim Styles
- Features Portable Control Station
- Solid, Single Piece Frame for Added Capacity and Dependability

**INCLUDES:** Manufacturer's Set Up

**WARRANTY:** 1 Year Parts and 6 Months Labor



### Coats® 6450-3D Heavy Duty Balancer

SKU **OSB**  
**AMM64503DKT1P 20,499<sup>99</sup>**

- **Kit Includes Wheel Lift Plus Lug and Hub Centered Budd Style Adapters**
- Dual Calibration Software Stores and Runs Two Independent Sets of Calibrations
- Powerful 1.5 HP Direct Drive Motor Shaves 20 Seconds Off of a Typical 22.5" Spin
- Designed for High Volume Balancing, the Perfect Machine for Delivery Vehicles and Tractor Trailers
- Max. Tire Diameter: 52"
- Max. Tire Weight: 500 Lb.

**INCLUDES:** Manufacturer's Set Up

**WARRANTY:** 1 Year Parts and 6 Months Labor



### Super-Duty Truck Tire Changer

SKU **OSB**  
**RANR26FLT 12,799<sup>99</sup>**

- Super-Duty Electric Motor and Hydraulic Drive for Superior Torque and Wheel Holding Power
- Heavy, Tapered Roller Bearings and a Dual Direction Hydraulic Motor Provide Smooth Torque
- Self-Centering Hydraulic Clamping Chuck
- Quick Positioning and Locking Mount/Demount
- Hydraulically Operated Spreader Jaws
- Voltage: 208V to 230V; 60Hz
- Max. Rim Diameter: 14" to 26"
- Max. Tire Diameter: 63"



### RB30T Heavy-Duty Truck Wheel Balancer with Adapter Kit

SKU **OSB**  
**RANRB30T 13,499<sup>99</sup>**

- Five Distinct Balancing Modes: Dynamic, Static, ALU1, ALU2, and ALUS for Total Compatibility with Steel and Aluminum Wheels
- Integrated Pneumatic Wheel Lift Handles Up to 330 Lb. for Easy Mounting and Reduced Strain on Technicians
- High-Precision 64-Bit Digital Architecture and Single-Chip Control System for Ultra-Fast Data Processing
- Rugged 40 mm Precision-Machined, Hardened-Steel Shaft Ensures Long-Term Durability and Repeatable Clamping
- Supports Wheels Up to 49.25" in Diameter, 20" Wide, and Up to 330 Lb. in Weight
- Dual-Unit Display Allows User Preference Between Gram/Ounce and Inch/Millimeter Readouts
- Max. Wheel Diameter: 30"
- Max. Tire Diameter: 50"



Customer Responsible For Offloading, Liftgate Service Available.

For OSB, Call 901-300-4878

- Free Delivery in 48 Continental United States
- Specifications Subject to Change without Notice or Liability
- Equipment Lead Times and Shipping May Vary
- Customers Responsible for Offloading Equipment Upon Arrival
- Leasing Terms Available. Ask Your AutoZone® Commercial Sales Manager.

# HEAVY DUTY

FOR HELP with Selection, Confirm Availability and Ordering Instructions, Call 901-300-4878

HEAVY DUTY

## Heavy Duty Lifts

### 14,000 Lb. Mobile Lift, Single Column

SKU 1580895  
CHLCLHM-140 **12,719<sup>99</sup>**

- 110 Volt Charging System
- Completely Wireless System
- Adjustable Wheel Carriage Adapts from 5" to 24.5"
- Integrated Touch-Screen Control Console at Each Column Allows Operation from Any Unit
- 14,000 Lb. Capacity per Column
- Includes: Batteries, Fluids and Factory Training

WARRANTY: 2 Years Parts and 1 Year Labor

**CL Challenger Lifts**



New AGM Batteries Carry a 2 Year Free Replacement Warranty

### 27,000 Lb. Heavy Duty Truck Lift

SKU OSB  
BENHDS27 **22,549<sup>99</sup>**

- Runways Include Rail-Kit for Optional Accessories
- Runways Adjust for Different Tread Widths
- Electric/Hydraulic Power System
- Fully Enclosed Lifting Cables, Safety Locks and Sheaves
- Pneumatic Push-Button Safety Release
- Length: 24-3/4'

WARRANTY: 1 Year Parts and Labor

**BendPak**



Customer Responsible For Offloading.

For OSB, Call 901-300-4878

## Lifting Equipment

### 6,000 Lb. Heavy Duty Engine Crane

SKU 1267948  
AFF3584

**1,579<sup>99</sup>**

- 4 Different Boom Settings: 3, 2, 1.5 and 1 Ton
- Rear of Crane: 61.5" Tall and 33" Wide
- Distance Between Front of Legs: Retracted 23", Extended 28.5"



### 35 Ton Air Hydraulic Axle Jack

SKU 954200  
AFF536 **1,869<sup>99</sup>**

- Unique Motor Design Advances Ram to Load Faster
- Air Assisted Lowering and Dual Return Springs Provide Controlled and Easy Descent
- Safety Overload System Prevents Jack from Being Used Beyond its Rated Capacity
- Corrosion Resistant Aluminum and Nylon Composite Air Motor



### 4,400 Lb. Transmission Jack

SKU 954183  
AFF3180A **1,849<sup>99</sup>**

- Heavy Duty with a Rated Capacity of Over 2 Tons
- Rugged Industrial Grade 4" Casters
- Fully Adjustable Saddle
- Extra-Long 32" Handle
- Safety Chain Included
- 8.5" Low Height
- Convenient Side Tray to Store Small Tools and Parts



### 10 Ton Air/Hydraulic Service Jack

SKU OSB  
AFF3135 **1,969<sup>99</sup>**

- Large, Rugged 4-1/2" Front Wheels and 2-3/4" Rear Casters
- Can Be Operated Manually When Shop Air is Not Available
- Foot-Operated Pump for Quick Lifting Efficiency
- Automatic Overload Safety Valves
- Chassis Length: 61"
- Low Height: 7"
- Width: 18"



## Locknut Sockets

**OEM TOOLS**

### 7 Piece Wheel Bearing Locknut Set

SKU 1207886  
37385 **119<sup>99</sup>**

- Includes: 55 mm 6PT, 2-3/8" 6R, 2-3/8" 6PT, 2-1/2" 6R, 2-1/2" 6PT, 2-9/16" 6R and 2-3/4" 6R
- Comes with Standard Hex (6PT) and Rounded (6R) Hex Sockets to Fit Many Applications
- For Use with 1/2" Square Drive Ratchet, Breaker Bar or Torque Wrench



### 5 Piece Budd Wheel Socket Set

SKU 1207878  
37384 **179<sup>99</sup>**

- 35 mm, 38 mm, 41 mm and 1-1/2" Sockets Feature a Dual Socket Design with a Hex to Remove the Lug Nut and an Internal Square Drive to Remove the Inside Wheel
- 38 mm, 41 mm and 1-1/2" Sockets Each Have a 13/16" Internal Square
- 35 mm Socket Has a 11/16" Internal Square
- For Use with 1" Drive Ratchet, Breaker Bar, Torque Wrench and Impact Wrench



### Truck Axle Wheel Bearing Sockets

- 3/4" Square Drive
- Constructed with High-Grade Steel for Strength



#### 4", 6 Pt.

SKU 466541  
25482 **41<sup>99</sup>**

#### 2-9/16", 8 Pt.

SKU 466534  
25473 **22<sup>99</sup>**

#### 4-1/8", 6 Pt.

SKU 265085  
25483 **34<sup>99</sup>**

#### 4-3/8", 8 Pt.

SKU 466543  
25485 **34<sup>99</sup>**

## Heavy Duty Stands

### 22 Ton Heavy Duty Axle Stands (Pair)

SKU 757098  
24854 **249<sup>99</sup>**

- Min. Height: 12-1/4"
- Max. Height: 19-3/4"
- Adjustable Pin Design
- Features Handle for Transport and Positioning
- Large Shaped Saddles Center Lift Points for Secure Placement



**OEM TOOLS**

## Heavy Duty Truck Oil Filter Wrenches

### Small

SKU 344322  
25231 **34<sup>99</sup>**

- Range: 4-1/8" to 4-5/8" (104 to 118 mm)

### Medium

SKU 344323  
25232 **34<sup>99</sup>**

- Range: 4-5/8" to 5-1/4" (118 to 134 mm)

### Large

SKU 344324  
25233 **39<sup>99</sup>**

- Range: 5-1/4" to 5-3/4" (134 to 142 mm)



**OEM TOOLS**

- Free Delivery in 48 Continental United States
- Specifications Subject to Change without Notice or Liability
- Equipment Lead Times and Shipping May Vary
- Customers Responsible for Offloading Equipment Upon Arrival
- Leasing Terms Available. Ask Your AutoZone® Commercial Sales Manager.

Prices subject to change without notice. Prices do not include applicable taxes, vehicles, tires, rims, installation or optional equipment as shown. Please do not return purchases to the store. For information regarding warranty, repair, or any questions or concerns, call 901-300-4878.

AZG0226

117

# TOOL STORAGE



- 24" Deep Drawers
- 100/200 Lb. Drawer Capacity
- Non-Slip PVC Drawer Liners
- UV Protected Finish
- Constructed with 16 G Steel Frame
- Lift Latch Drawer Pulls

ALSO AVAILABLE IN



**Homak**

## 72" 16 Drawer Rolling Cabinet with Stainless Steel Top – Green

SKU 1267935  
HOM72RSPRCSG

**2,799<sup>99</sup>**

- 72" (W) x 24" (D) x 40" (H)



## 54" 10 Drawer Rolling Cabinet with Stainless Steel Top – Blue

SKU 1343816  
HOM54RSCABSBL

**2,129<sup>99</sup>**

- 54.5" (W) x 24" (D) x 40.375" (H)



## 72" 3 Drawer Hutch – Black

SKU OSB  
HOM72RSPHUTBK

**1,649<sup>99</sup>**

- 71.5" (W) x 23.5" (D) x 24.375" (H)



## 54" Top Hutch – Blue

SKU 1343820  
HOM54RSPHUTBL

**1,249<sup>99</sup>**

- 54" (W) x 23.5" (D) x 24.375" (H)



## 72" 16 Drawer Roller Cabinet – Black

SKU OSB  
HOM72RSPRCBBK

**2,549<sup>99</sup>**

- 72" (W) x 24" (D) x 39.25" (H)



## 54" 10 Drawer Rolling Cabinet – Blue

SKU 1442581  
HOM54RSPCABBL

**1,949<sup>99</sup>**

- 54.5" (W) x 24" (D) x 40.375" (H)



## 72" 12 Drawer Top Chest – Blue

SKU OSB  
HOM72RSPCHSTOBL

**1,779<sup>99</sup>**

- 72" (W) x 23.5" (D) x 21.375" (H)



## 54" 8 Drawer Top Chest – Black

SKU OSB  
HOM54RSCHSTBK

**1,359<sup>99</sup>**

- 54" (W) x 23.5" (D) x 21.375" (H)



## 72" 16 Drawer Roller Cabinet – Blue

SKU OSB  
HOM72RSPRCBBL

**2,549<sup>99</sup>**

- 72" (W) x 24" (D) x 39.25" (H)



## 54" 10 Drawer Rolling Cabinet – Black

SKU OSB  
HOM54RSPCABBK

**1,929<sup>99</sup>**

- 54.5" (W) x 24" (D) x 40.375" (H)



Customer Responsible For Offloading, Liftgate Service Available.

For OSB, Call 901-300-4878

- Free Delivery in 48 Continental United States
- Specifications Subject to Change without Notice or Liability
- Equipment Lead Times and Shipping May Vary
- Customers Responsible for Offloading Equipment Upon Arrival
- Leasing Terms Available, Ask Your AutoZone® Commercial Sales Manager.

# TOOL STORAGE

FOR HELP with Selection, Confirm Availability and Ordering Instructions, Call 901-300-4878

TOOL STORAGE



- 24" Deep Drawers
- 100/200 Lb. Drawer Capacity
- Non-Slip PVC Drawer Liners
- UV Protected Finish
- Constructed with 16 G Steel Frame
- Lift Latch Drawer Pulls

ALSO AVAILABLE IN



## 44" 8 Drawer Power Service Cart – Gray

SKU 1282738  
HOMRSPRO44G **1,769<sup>99</sup>**

- Top Till Includes Full-Extension Gas Struts and a Lockable Security Compartment with an Additional Power Strip to Store and Charge Phones, Laptops and Other Devices
- Equipped with High Security Locking System to Keep Valuables Safe and Secure
- 40.5"(W) x 23.9"(D) x 40.2"(H)

Features 4 Electric Outlets and 2 USB Ports to Efficiently Charge, Store and Organize Power Tools in One Place



## 54" 7 Drawer Rolling Workstation - Blue

SKU 1485046  
HOM54RWSBL **1,669<sup>99</sup>**

- Durable Stainless Steel Work Surface
- Four (4) 5x2" Casters with a Weight Capacity of 520 Lb. Each: 2 Swivel Locking and 2 Fixed
- 57.5"(W) x 29"(D) x 41"(H)

Features 4 Electric Outlets and 2 USB Ports to Efficiently Charge, Store and Organize Power Tools in One Place



## 35" 4 Drawer Slide Top Cart – Blue

SKU 1343821  
HOM35STCBL **784<sup>99</sup>**

- 35"(W) x 20.625"(D) x 42"(H)



## 35" 7 Drawer Flip-Top Service Cart - White

SKU OSB  
HOM35FTSCWH **1,189<sup>99</sup>**

- 31"(W) x 22.5"(D) x 38.875"(H)



## 32" Professional 1 Drawer Service Cart - Blue

SKU 1343817  
HOM32PSCBL **359<sup>99</sup>**

- 31.5"(W) x 17.5"(D) x 35.625"(H)



## 35" Professional 4 Drawer Flip Top Service Cart - Red

SKU 1343822  
HOM35PSCR **789<sup>99</sup>**

- 35"(W) x 20.5"(D) x 39.375"(H)

## 30" 2 Shelf Utility Cart

SKU OSB  
HOMPP06032021 **159<sup>99</sup>**

- Load Capacity Up to 300 Lb.
- Tray-to-Tray Distance of 22.4"
- Four 4" x 1" Casters: Two Swivel, Two Fixed



## 2 Shelf Utility Cart

- Load Capacity Up to 300 Lb.
- Four 4" x 1" Casters: Two Swivel, Two Fixed

### 30"

SKU OSB  
HOMPP06039021

**199<sup>99</sup>**

- Tray-to-Tray Distance: 23.6"

### 36"

SKU OSB  
HOMPP06046021

**299<sup>99</sup>**

- Tray-to-Tray Distance: 24"



## 30" 3 Tier Utility Cart

SKU 1414408  
HOMPP06032031 **399<sup>99</sup>**

- Load Capacity Up to 300 Lb.
- Tray-to-Tray Distance of 16.1"
- Four 4" x 1" Casters: Two Swivel, Two Fixed



Customer Responsible For Offloading, Liftgate Service Available.

For OSB, Call 901-300-4878

- Free Delivery in 48 Continental United States
- Specifications Subject to Change without Notice or Liability
- Equipment Lead Times and Shipping May Vary
- Customers Responsible for Offloading Equipment Upon Arrival
- Leasing Terms Available, Ask Your AutoZone® Commercial Sales Manager.

Prices subject to change without notice. Prices do not include applicable taxes, vehicles, tires, rims, installation or optional equipment as shown. Please do not return purchases to the store. For information regarding warranty, repair, or any questions or concerns, call 901-300-4878.

AZG0226

# TOOL STORAGE

## 28" 7 Drawer - Molded Worktop

SKU 477172 **699<sup>99</sup>**  
24566

- Dimensions: 28.3"(W) x 18.9"(D) x 40.5"(H)
- Storage Space: 9,505 Cubic Inches
- Fully Sealed Plastic Work Surface is Solvent Resistant
- Integrated Pegboard Provides Additional Storage and Organization



## 36" 8 Drawer

SKU 477134 **1,099<sup>99</sup>**  
24565

- Dimensions: 35.8"(W) x 18.9"(D) x 39.3"(H)
- Storage Space: 12,594 Cubic Inches
- Stainless Steel Work Top is Corrosion Resistant and Easy to Clean



## 36" Slide Top 3 Drawer Tool Cart - Green

SKU 666298 **1,109<sup>99</sup>**  
24731

- Constructed with a 19 Gauge Steel Shell and 21 Gauge Steel Drawers
- Full Length Anodized Aluminum Drawer Pull
- Shallow Drawer Dimensions: 30"(W) x 18"(D) x 2.9"(H)
- Deep Drawer Dimensions: 30"(W) x 18"(D) x 6.1"(H)
- Overall Dimensions: 36"(W) x 21"(D) x 46"(H)



Access Your Most Used Tools with an OEMTOOLS Side Top Tool Cart

## 57" 22 Drawer Professional Combo

SKU 662893  
24738

**2,999<sup>99</sup>**

- Total Loading Capacity: 2,697 Lb.
- Casters Rated to 880 Lb. Each
- Overall Dimensions: 57"(W) x 24"(D) x 66.5"(H)
- Storage Space: 41,466 Cubic Inches
- Drawer Space: 13,404 Sq. Inches



**SAVE \$849**  
When you buy the combo

## 57" 10 Drawer Professional Chest

SKU 666333 **2,599<sup>99</sup>**  
24737

- Overall Dimensions: 57"(W) x 24"(D) x 26"(H)
- Storage Space: 14,221 Cubic Inches



## 57" 12 Drawer Professional Cabinet

SKU 666300 **3,199<sup>99</sup>**  
24736

- Overall Dimensions: 57"(W) x 24"(D) x 40.5"(H)
- Storage Space: 22,528 Cubic Inches

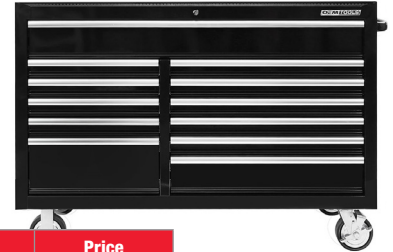

Part #	Description	Price
24734 or 24737	57" 10 Drawer Professional Chest	\$2,599.99
24733 or 24736	57" 12 Drawer Professional Cabinet	\$3,199.99
	Regular Price	\$5,799.98
24735 or 24738	COMBO PRICE	\$4,949.99
	SAVINGS	\$849.99

## 57" 22 Drawer Professional Combo

SKU OSB  
24735

**2,999<sup>99</sup>**

- Total Loading Capacity: 2,697 Lb.
- Casters Rated to 880 Lb. Each
- Overall Dimensions: 57"(W) x 24"(D) x 66.5"(H)
- Storage Space: 41,466 Cubic Inches
- Drawer Space: 13,404 Sq. Inches



## 57" 10 Drawer Professional Chest

SKU 666290 **2,599<sup>99</sup>**  
24734

- Overall Dimensions: 57"(W) x 24"(D) x 26"(H)
- Storage Space: 14,221 Cubic Inches



## 57" 12 Drawer Professional Cabinet

SKU OSB **3,199<sup>99</sup>**  
24733

- Overall Dimensions: 57"(W) x 24"(D) x 40.5"(H)
- Storage Space: 22,528 Cubic Inches



Customer Responsible For Offloading, Liftgate Service Available.

For OSB, Call 901-300-4878

- Free Delivery in 48 Continental United States
- Specifications Subject to Change without Notice or Liability
- Equipment Lead Times and Shipping May Vary
- Customers Responsible for Offloading Equipment Upon Arrival
- Leasing Terms Available, Ask Your AutoZone® Commercial Sales Manager.

# TOOL STORAGE

FOR HELP with Selection, Confirm Availability and Ordering Instructions, Call 901-300-4878

TOOL STORAGE

## 72" Stainless Steel 11 Drawer Cabinet and Upper Cabinet

SKU 1168659 **1,599<sup>99</sup>**  
OEM24615

### Features:

- Dimensions: 72"(W) x 18"(D) x 71.5"(H)
- Upper Cabinet is 12"(H) x 18"(D)
- Drawer Liners Included

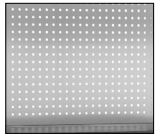

18" Tall Pegboard



Full Extension 100 Lb. Capacity Slides



PVC Coated MDF Top



Heavy Duty Casters 5" x 2"



OEM TOOLS

## Tear Down Tray

VIKING

### Adjustable Mobile Work Table 200 Lb. Capacity

SKU 1485038 **199<sup>99</sup>**  
VIK52200

- Adjustable Tray
- Heavy Duty 2" Rubber Composite Swivel Casters
- Multiple Storage Slots, Trays and Insert Grooves Keeps Tools and Parts Organized and Within Reach
- 1" Drawer with Roller Bearing Slides Offer Additional Storage Capacity



Tools Not Included



## Steel Workbenches

Homak

- Black Powder Coat Finish
- Engineered for Quick Assembly
- Built-In Leg Levelers

### 59" Steel Workbench

SKU 1392321 **459<sup>99</sup>**  
HOMGW00550150

- Weight Capacity: 880 Lb.



### 59" Steel Workbench with 2 Drawers

SKU 1392318 **614<sup>99</sup>**  
HOMGW00550170

- High Security Tubular Lock System
- Ball-Bearing Drawer Slides
- Weight Capacity: 1100 Lb.



### 79" Steel Workbench with 3 Drawers and Wood Top

SKU 1392314 **584<sup>99</sup>**  
HOMGS00579030

- 1.5" Wood Work Surface with Top Mat
- Weight Capacity: 440 Lb.



### 79" Steel Workbench with 3 Drawers

SKU 1392331 **789<sup>99</sup>**  
HOMGW00550160

- High Security Tubular Lock System
- Ball-Bearing Drawer Slides
- Weight Capacity: 1100 Lb.



## Diagnostic Cart

Homak

### Mobile Diagnostic and Testing Terminal

- 100 Lb. Drawer Capacity
- Diagnostic Tool Cord Management and Power Tool Storage Area
- Swivel Wheels and Large Handles for Easy Maneuverability
- EVA Drawer Liners
- 3.2 mil UV-Protected Powder Coat Finish
- Lift-Latch Drawer Pulls and Ball-Bearing Drawer Slides

#### Blue

SKU OSB  
HOMBB06019020

**639<sup>99</sup>**

#### Orange

SKU OSB  
HOMOB06019020

**639<sup>99</sup>**



NEW

For OSB,  
Call 901-300-4878

## Field Boxes

SHEFFIELD

### XL Field Box

- 4 Locking Options for Security
- Compression Fit Lid with Rubber Gasket for Water and Dust Resistance
- Manufactured with Impact, Abrasion and Crack Resistant Copolymer Plastics
- Food Safe and Resistant to Most Acids and Solvents
- External Dimensions: 14" (L) x 9" (W) x 9-1/4" (H)
- Internal Dimensions: 12-5/8" (L) x 6-5/8" (W) x 8" (H)

#### Olive Green

SKU 989218  
12710

**27<sup>99</sup>**



#### Black

SKU 1392313 **27<sup>99</sup>** 12710

### XL Field Box with Lift Out Storage Tray

- Lift-Out Tray with 8 Compartments

#### Olive Green

SKU 989216  
12712

**34<sup>99</sup>**

#### Black

SKU 1392328 **34<sup>99</sup>**  
12701



#### White

SKU 1392312  
12721

**34<sup>99</sup>**



Customer Responsible For Offloading, Liftgate Service Available.

- Free Delivery in 48 Continental United States
- Specifications Subject to Change without Notice or Liability
- Equipment Lead Times and Shipping May Vary
- Customers Responsible for Offloading Equipment Upon Arrival
- Leasing Terms Available, Ask Your AutoZone® Commercial Sales Manager.

Prices subject to change without notice. Prices do not include applicable taxes, vehicles, tires, rims, installation or optional equipment as shown. Please do not return purchases to the store. For information regarding warranty, repair, or any questions or concerns, call 901-300-4878.

AZG0226

121

# TOOL ORGANIZATION

## 2 Post Socket Trays

### 6 Piece Socket Tray Sets

- Metric Socket Range: 4 mm to 15 mm (1/4" Drive), 6 mm to 20 mm (3/8" Drive), 10 mm to 27 mm (1/2" Drive)
- SAE Socket Range: 1/8" to 5/8" (1/4" Drive), 1/4" to 1" (3/8" Drive), 3/8" to 1-1/4" (1/2" Drive)
- Includes: 6 Trays - 1/4", 3/8" and 1/2" Drive in Both Metric and SAE



Tools Not Included

**Metric** **Black and Green**  
SKU 949573  
22233  
**SAE** **36<sup>99</sup>**

**Metric** **Black and Orange**  
SKU 1142583  
22418  
**SAE** **36<sup>99</sup>**

**Metric** **Gray and Red**  
SKU 477209  
22413  
**SAE** **36<sup>99</sup>**

## 3 Piece Socket Trays

**OEM TOOLS**

- Includes: 3 Trays - 1/4", 3/8" and 1/2" Drive

**SAE** **Green**  
SKU 749921  
22207  
**30<sup>99</sup>**

**Metric** **Black**  
SKU 749937  
22211  
**30<sup>99</sup>**



Tools Not Included

## Magnetic Socket Tray Sets

### 3 Piece Magnetic Socket Tray Set Metric or SAE

- Includes: 3 Trays - 1/4", 3/8" and 1/2" Drive in Metric or SAE

**Blue (Metric)** **Metric**  
SKU 1149155  
22486 **59<sup>99</sup>**

**Black (Metric)** **Metric**  
SKU 1149156  
22487 **59<sup>99</sup>**

**Red (SAE)** **SAE**  
SKU 1149183  
22484 **59<sup>99</sup>**

**Green (SAE)** **SAE**  
SKU 1149165  
22485 **59<sup>99</sup>**



**OEM TOOLS**



### 6 Piece Magnetic Socket Tray Set - Metric and SAE

- Includes: 6 Trays - 1/4", 3/8" and 1/2" Drive in Both Metric and SAE

**Black and Green** **Metric** **SAE**  
SKU 1331490  
22488 **89<sup>99</sup>**

**Blue and Green** **Metric** **SAE**  
SKU 1392463  
22461 **89<sup>99</sup>**

**Black and Red** **Metric** **SAE**  
SKU 1485048  
22460 **89<sup>99</sup>**

**Blue and Red** **Metric** **SAE**  
SKU 1331485  
22489 **89<sup>99</sup>**



- SAE**
- 1/4" Tray Holds 2 Sets of Sockets 1/8" to 5/8"
  - 3/8" Tray Holds 2 Sets of Sockets 3/8" to 7/8"
  - 1/2" Tray Holds 1 Set of Sockets 3/8" to 1-1/4"

- METRIC**
- 1/4" Tray Holds 2 Sets of Sockets 4 mm to 14 mm
  - 3/8" Tray Holds 2 Sets of Sockets 6 mm to 20 mm
  - 1/2" Tray Holds 1 Set of Sockets 10 mm to 27 mm

Tools Not Included

## Pro Socket Organizer

**OEM TOOLS**

### Magnetic Socket Tray

SKU 082922 **44<sup>99</sup>**  
22389

- Store Up to 36 Total Sockets - 1/4", 3/8" and 1/2" Drive
- Removable Back Panel Allows Magnets to Adhere to Any Magnetic Surface

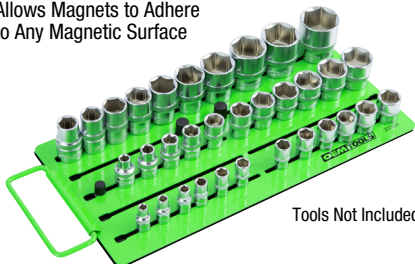

Tools Not Included

## Magnetic Socket Organizers

**OEM TOOLS**

### Portable Magnetic Socket Organizers

- Holds Up to 28 Sockets
- Powerful Magnets Hold Sockets Securely and Attach Organizer to Any Magnetic Surface
- Low-Profile Design Fits Most Toolbox Drawers



**3/8" Drive**  
SKU 1442590 **31<sup>99</sup>**  
23117

**1/2" Drive**  
SKU 1414403 **34<sup>99</sup>**  
23118



Tools Not Included

## Tool Holder

**OEM TOOLS**

### Magnetic Tool Holder

SKU 749848 **34<sup>99</sup>**  
22212

- 18" Rail with 16 Sliding Clips
- Multipurpose Clips Hold a Variety of Tools
- Great for Screwdrivers, Ratchets, Wrenches, Pliers and Other Small Tools
- Powerful Magnet for Secure Hold
- Foam Shield to Protect Paint Finishes



# TOOL ORGANIZATION

TO ORDER, contact your Commercial Sales Manager or go to [AutoZonePro.com](http://AutoZonePro.com)

TOOL ORGANIZATION

## Magnetic Trays

### 4 Piece Magnetic Foldable Tray

SKU 1207890 **33<sup>99</sup>**  
26052

- Collapsible Tray Expands from 3/4" to 2" Deep
- Holds Up to 2 Lb.
- Multiple Color Set Keeps You Organized
- Dimensions: 4-1/2" x 4-1/2"



Tools Not Included

## Magnetic Trays

- Trays Stick to Most Metal Surfaces
- Ideal for Holding Small Parts and Tools
- Heavy Duty Stainless Steel

### 5" x 9"

SKU 965834 **14<sup>99</sup>**  
25117C

- 2 Powerful Magnets with Protective Rubber Coating to Resist Scratching



### 10" x 11"

SKU 965835 **30<sup>99</sup>**  
25119

- 4 Powerful Magnets with Protective Rubber Coating to Resist Scratching



Tools Not Included

## Organizers

### 16 Piece Pliers Holder

SKU 765589 **20<sup>99</sup>**  
22215

- 16 Extra-Wide Spaces for Pliers with Rubber Grips
- Vinyl Coating for Lasting Dependability
- Dimensions: 14.0" (L) x 5.2" (W) x 2.5" (H)



Tools Not Included

### Drawer Organizer Tray

SKU 749932 **19<sup>99</sup>**  
22213

- Rolled Bottom Edges Allow Easy Removal of Small Parts
- Low-Profile Fits in Shallow Toolbox Drawers
- 10-Compartment Tray
- Stackable Design
- Dimensions: 16" (L) x 11" (W) x 1.5" (H)



## Magnetic Bit Holders

### 4 Piece Magnetic Hex Bit Trays

SKU 1284964 **39<sup>99</sup>**  
24142

- Each Tray Holds 36 Hex Bits
- Coated Magnetic Trays Adhere to Most Metal Surfaces



## Paper Towel Holder

### Magnetic Paper Towel Holder

SKU 280376 **11<sup>99</sup>**  
24952

- Adjusts to Fit Different Size Rolls
- 3 Rubber-Faced Magnets Won't Scratch Metal Surfaces



Towel Roll Not Included

## Wrench Organizers

### 4 Piece Magnetic Wrench Rails

- Holds 40 Wrenches
- Includes: 4 Rails
- Rail Dimensions: 16.6" (L) x 1.9" (H)

**Green** SKU 749850 **28<sup>99</sup>**  
22217

**Black** SKU 765514 **28<sup>99</sup>**  
22219



Tools Not Included

### 2 Piece Wrench Organizing Rails - Black

SKU 213161 **11<sup>99</sup>**  
22218

- Holds 35 Wrenches
- Slotted Design Will Fit a Variety of Wrench Types and Sizes
- Rail Dimensions: 23.4" (L) x 1.0" (H)

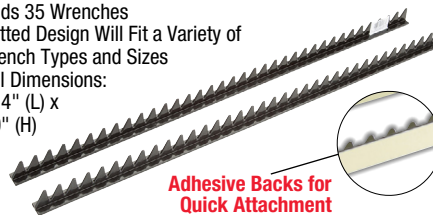

Adhesive Backs for Quick Attachment

### Magnetic Wrench Organizer

SKU 662782 **17<sup>99</sup>**  
22177

- Organize Up to 12 Wrenches
- Strong Magnets Will Hold Organizer Upright at Full Capacity
- Non-Marring Foam Backing
- Durable Coated Steel Construction



Tools Not Included

### Pro Magnetic Wrench Organizer (Black)

SKU 213098 **17<sup>99</sup>**  
22176

- Organize Up to 12 Wrenches
- Strong Magnets Will Hold Organizer Upright at Full Capacity
- Non-Marring Foam Backing
- Durable Coated Steel Construction



### Magnetic Wrench Holder and Organizer

- Holds 10 SAE or Metric Wrenches
- Magnetic Base Attaches to Your Tool Box, Tool Chest, Cart or Metallic Peg Board
- Dimensions: 9-1/4" (L) x 1-1/4" (W) x 2" (D)

**Green** SKU 1331491 **16<sup>99</sup>**  
22512



**Black** SKU 1331501 **16<sup>99</sup>**  
22513



Tools Not Included

Prices subject to change without notice. Prices do not include applicable taxes, vehicles, tires, rims, installation or optional equipment as shown. Please do not return purchases to the store. For information regarding warranty, repair, or any questions or concerns, call 901-300-4878.

# SHOP EQUIPMENT

## Shop Presses

### 20 Ton Super Duty Air/Manual Shop Press

SKU 1544673 **1,299<sup>99</sup>**  
29000

- Fully Welded Construction and Powder-Coated Steel Frame for Unmatched Durability
- Movable Cylinder and 10 Height Adjustments with 4.3" Increments for Operator Versatility
- Glycerin-Filled Pressure Gauge Ensures Precise Pressure Readings Every Time
- Air/Hydraulic Pump Supports Both Manual and Pneumatic Operation (110-120 psi)
- Includes Anti-Slip Steel Blocks and Meets ASME PASE-2019 Standards

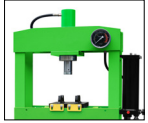

Adjustable Hydraulic Cylinder



Fully Welded Construction

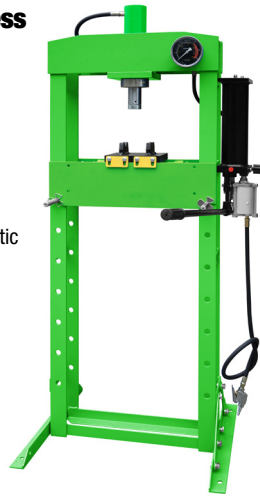

### 30 Ton Super Duty Air/Manual Shop Press

SKU 1525570 **1,674<sup>99</sup>**  
29001

- Fully Welded Construction for Exceptional Strength and Durability
- Movable Cylinder for Added Flexibility In Working Position
- Glycerin Filled Pressure Gauge for Accurate Pressure Readings
- Polycarbonate Protective Guard Shield for Maximum Safety Against Shrapnel and Debris
- Air/Hydraulic Pump Supports Both Manual and Pneumatic Operation (110 to 120 psi)
- Includes Anti-Slip Steel Blocks and Meets ASME PASE-2019 Standards

**Polycarbonate Protective Guard Shield for Maximum Safety Against Shrapnel and Debris**

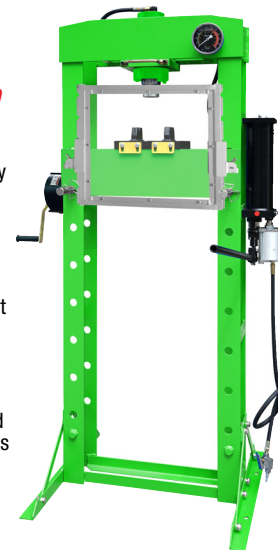

OEM TOOLS®

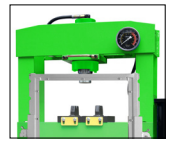

Adjustable Hydraulic Cylinder



Glycerin Filled Pressure Gauge

### 20 Ton Air Hydraulic Shop Press

SKU 662928 **999<sup>99</sup>**  
25087

- Removable Press Cap with 25 mm Hole to Accept OEMTOOLS Press Pin Set (#24813)
- Air/Hydraulic Pump Provides Added Versatility
- Double Speed Pump Greatly Reduces Set-Up and Press Time
- Movable Press Head for Flexibility of Working Positions
- Liquid Filled Pressure Gauge for Accurate Pressure Readings
- Durable Powder Coated Steel Frame
- Includes Press Blocks



Liquid Filled Dual Scale Gauge

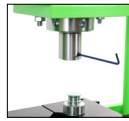

Removable Press Cap with 25 mm Hole



### 10 Ton Hydraulic Bench Top Shop Press

SKU 666327 **499<sup>99</sup>** REG. \$599.99  
25088

- Removable Press Cap with 25 mm Hole to Accept OEMTOOLS Press Pin Set (#24813)
- Double Speed Pump Greatly Reduces Set-Up and Press Time
- Movable Press Head for Added Flexibility in Working Position
- Liquid Filled Pressure Gauge

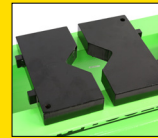

Press Blocks Included

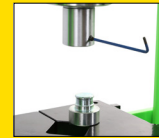

Removable Press Cap



**SAVE \$100**

Offer Good Through June 30, 2026

## Press Accessories

### 8 Piece Press Accessory Kit

SKU 1525566 **199<sup>99</sup>**  
29002

- Includes: 2 Press Plates, 5 Punches and a Bearing Shield
- Sizes 1/2", 3/4", 1", 1-1/2" and 2"
- Capacity: Up to 50 Tons

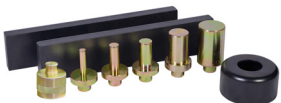

### 30 Ton X Style Press Plates

SKU 1544680 **99<sup>99</sup>**  
24808

- For Use on All Presses Up to 30-Ton Capacity
- "X" Type Design for Use in Many Different Pressing Operations
- 1.2" Steel Thickness to Comply with ASME PASE Requirements



### Shop Press Pin Set

SKU 544794 **149<sup>99</sup>**  
24813

- Includes: Set of 8 Press Pins (2-20 Ton Capacity), 25 mm Quick Change Adapter Chuck and Mountable Bracket
- Suitable for Use with Hydraulic Ram Style Shop Presses That Have a Female Ram Assembly Diameter of 25 mm and are Secured with a Bolt
- Works with OEMTOOLS 24811, 24812, 25087 and 25088
- Not for Use with Bottle Jack Style Shop Presses



### Universal Press Support

SKU 804487 **249<sup>99</sup>**  
24809

- Will Make Your Shop Press Safe and Easy to Use
- Supports in 3 Points to Ensure Safe Support without Any Wobbling
- Numerous Holes on Main Block and Swivel Element for Easy Set-Up
- Swivel Element and Removable/Height Adjustable Anvil Bolts Allow Adjustment to Individual Requirements
- Dimensions: 7-3/4" (W) x 9-3/4" (L) x 1-1/2" (H)

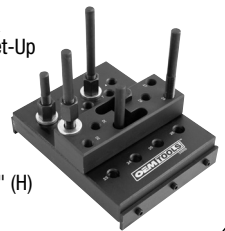

## Bearing Separators

### 5 Ton Bar-Type Puller/Bearing Separator Set

SKU 347218 **79<sup>99</sup>**  
27236

- Separator Tools are Used with Bar Puller and Legs for a Wide Variety of Pulling Jobs
- Set Includes: 2" and 3" Bearing Splitters, 4 Sets of Hex Push-Puller Legs and a Bar-Type Puller Head with a 9/16" Forcing Screw

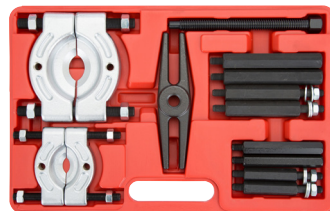

### Bearing Splitter 1/4" to 15/16"

SKU 514005 **26<sup>99</sup>**  
27231

- Maximum Spread: 15/16"
- Minimum Spread: 1/4"
- Thread of Tapped Holes in Adapter: 5/16" to 18"
- Distance Between Adjusting Screws: 1-11/16"



### Bearing Splitter 1/2" to 4-5/8"

SKU 514006 **74<sup>99</sup>**  
27232

### Bearing Splitter 1/8" to 2"

SKU 516522 **28<sup>99</sup>**  
27084

OEM TOOLS®

## Aqueous Parts Washers

- Works with Safe Water-Based Cleaning Solutions Only (Not for Use with Solvents)
- 325 GPH Pump
- Powder-Coated 20 Gauge Steel for Durability and Rust Resistance



### Steel Parts Washers

#### 3.5 Gallon Bench Top

SKU 300128 24800 **199<sup>99</sup>**

- Dimensions: 18" (L) x 13-1/2" (W) x 9" (H)



#### 20 Gallon Mobile

SKU 750449 24805 **389<sup>99</sup>**

- 4" Casters for Maneuverability
- Drain Tray with 2.9 Gallon Collection Reservoir
- Dimensions: 38" (L) x 21.5" (W) x 37" (H)



#### 20 Gallon

SKU 300117 24801 **369<sup>99</sup>**

- Small Parts Tray
- Dimensions: 31" (L) x 21" (W) x 34.5" (H)



#### 40 Gallon

SKU 300118 24803 **699<sup>99</sup>**

- Small Parts Tray
- Dimensions: 44.75" (L) x 20.5" (W) x 35" (H)



#### Pneumatic Heated Parts Washer Cabinet

SKU 1330681 24677 **799<sup>99</sup>**

- Compressed-Air Spray with Heated Cleaner for Maximum Cleaning Power
- Fully Enclosed Cabinet Keeps Solution and Debris Contained
- Thermostat-Controlled Heat Up to 140°F (60°C)
- Interior Light and Vent Fan for Better Visibility
- Built-In Regulator and Pressure Gauge
- Adjustable Leveling Pads for Uneven Floors
- 3.5-Gallon Solution Capacity



#### 4 Gallon Mobile Parts Washer

SKU 546660 24804 **222<sup>99</sup>**

- Lid Has Positive Seal and Latches for Mobility
- 4 GPM Pump
- Dimensions: 26" (L) x 18" (W) x 9.5" (H)



#### Portable Bucket-Top Parts Washer

SKU 003759 24816 **76<sup>99</sup>**

- Fits Most Standard 5 Gallon Buckets
- Includes: Submersible Pump, 40" Hose and Flow-Through Brush
- Pumping Rate: 1 GPM



## Aqueous Solutions

#### Blue Liquid Aqueous Concentrate

SKU 1485035 SRIPFOL2P-100 **159<sup>99</sup>**

- Designed for industrial Cleaning
- Concentrated Cleaning Solution for Biological Parts Cleaning
- Water Based
- ECO friendly



Innovates in maintenance products.

#### Heavy Duty Degreaser Concentrate (5 Gallons)

SKU 227558 WWSHD-5G **279<sup>99</sup>**

- Quickly Removes Grease, Oil, Carbon and Grime While Safe for the Technician



Designed to Effectively Replace Hazardous Solvent in Water-Based Parts Washers

## Washer Accessories



#### Straight Handle Flow Thru Parts Washer Brush

SKU 1368637 BRMPWA **39<sup>99</sup>**

- Made with Synthetic Filaments to Resist Solvent Cleaners
- Works with Most Popular Recirculating Parts Washers
- For Use in Either Petroleum-Based or Water Based Solutions



#### Parts Washer Brush without Tube

SKU 1368624 BRMPWANT **34<sup>99</sup>**



#### Air Operated Sprayer

SKU 222507 LIN5983 **84<sup>99</sup>**

- 1/4" NPT (F) Inlet
- Max. Operating Pressure: 150 psi
- Can Be Used with Solvents or Detergent Solutions



## Shop Vacuum



#### Air Blow and Suction Gun

SKU 1168663 26038 **59<sup>99</sup>**

- One-Touch Button That Changes the Gun from Blow to Suction
- Standard Shop Vacuum Power for Quick and Easy Clean Up
- Lightweight Gun
- High Filtration Collection Bag
- Rugged and Durable Metal Construction and Easy-to-Use Trigger
- 1/4" PT/NPT Inlet and 90 psi



# SHOP EQUIPMENT

## Floor Scrubbers

### Battery Powered 14" Floor Scrubber

SKU **OSB IPCCT15** **5,199<sup>99</sup>**

- Height-Adjustable Handle
- Removable Recovery Tank
- 1.5 Hour Run Time
- Includes: Lithium Battery, Charger and Brush



**WARRANTY:**  
10 Years Tank  
3 Years Parts  
3 Years Battery

For OSB, Call 901-300-4878

### Battery Powered 20" Floor Scrubber

SKU **OSB IPCCT50** **5,359<sup>99</sup>**

- 13 Gallon Tank Capacity
- 2.5 Hour Run Time
- For Up to 10 Bay Shop
- Includes: Self-Leveling Brush Head and Cast Aluminum Squeegee Assembly, 2 AGM Maintenance Free Batteries and Charger



**WARRANTY:**  
10 Years Tank  
3 Years Parts  
1 Year Battery

For OSB, Call 901-300-4878



## Abrasive Blasting



### Bench Top Abrasive Blast Cabinet

SKU **300119 24815** **299<sup>99</sup>**

- Easily Remove Paint, Rust and Oxidation
- Fits on the End of Any Bench or Cabinet
- Overall Height: 19.3"
- Exterior Width: 19.3"
- Work Area: 3.18 Cubic Ft.
- Includes: 10 Replaceable Window Underlays



### 25 Lb. Glass Bead Blasting Media

- Ideal for Many Uses
- Removes Surface Rust
- Paint and Body Applications

**Coarse**  
SKU **010136**  
**SHA13077**  
**189<sup>99</sup>**

**Medium**  
SKU **010139**  
**SHA13078**  
**189<sup>99</sup>**



## Spray Wash Cabinets

- Heavy Duty Steel Construction
- Removable Parts Tree
- Brass Nozzles
- Heavy Duty Rubber Casters
- Stainless Oil Skimmer
- Removable Tank Screen

Each Cabinet Includes:  
20 Lb. Aluma-Klean Soap Bucket  
RAN5155096

**VALUE:**  
**\$154.99**



Inside Height 43"

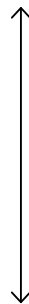

### Aluma-Klean Soap Bucket

**20 Lb.**  
SKU **751966**  
**RAN5155096**  
**154<sup>99</sup>**



**50 Lb.**  
SKU **1442593**  
**RAN5155100**  
**349<sup>99</sup>**



SKU	Part #	Product	Tank Capacity	Load Capacity	Price
1105323	RANRS500DS	Stainless Steel	50 Gallon	500 Lb. Load	<b>14,299.99</b>
1089035	RANRS750DS	Stainless Steel Truck	53 Gallon	1,000 Lb. Load	<b>15,299.99</b>
82919	RANRS500D	Professional	50 Gallon	500 Lb. Load	<b>9,099.99</b>
82920	RANRS750D	Truck	53 Gallon	1,000 Lb. Load	<b>9,899.99</b>



Customer Responsible for Offloading, Liftgate Service Available.

## Pipe Bender

### BB-2 Pipe Bender with 302 Die Package

SKU OSB BENBB2 **11,999<sup>99</sup>**

- Knee Control and Depth-of-Bend Degree Plate for Manual Bending Operations
- Includes: BB-2 Tooling Package, Quick Release Bending and Finishing Dies, High-Speed Clampless Swager and Internal Expander

### 1302 Automatic with 302 Die Package

SKU OSB BEN1302BAS302

**12,899<sup>99</sup>**



### Large 3" Die Package – Optional

SKU OSB BEN300-1 **1,649<sup>99</sup>**

- Optional Die Package Extends the Bending Capabilities of Your BendPak Pipe Bender



## Drill Press

### 15" 16 Speed Floor Drill Press

SKU 082857 24992

**799<sup>99</sup>**

- Drilling Depth: 3-5/16"
- 16 Speed Spindle: 240 to 3,200 RPM
- Dimensions: 15" x 25-1/3" x 63-1/3"
- Distance from Spindle to Table: 27"
- Distance from Spindle to Base: 47"



Chuck Size: 5/8" JT3 Taper

Swings: 15"

To Confirm Price, Availability and Ordering Instructions on OSB, Call 901-300-4878

## Hot Water Pressure Washers

### HSE 1400 psi Hot Water Pressure Washer

SKU OSB MTMHSE1400M11 **3,329<sup>99</sup>**

- Diesel or Kerosene Fired Burner
- 1400 psi, 2.0 GPM
- 1.5 HP, 120V
- Includes: 50' x 3/8" Wire Braided Hose, Adjustable Pressure Insulated Dual Lance with 15° Fixed and Detergent Nozzle



### HSE 1500 psi Hot Water Pressure Washer

SKU OSB MTMHSE15020MM **4,229<sup>99</sup>**

- Diesel or Kerosene Fired Burner
- Fuel Consumption: 1.2gph
- 1500 psi, 2.0 GPM
- Temperature Rise: 150°F (66°C); Max. Outlet Temperature: 200°F (93°C)
- Includes: Quick Connect Nozzles - 0°, 15°, 25° and 40°, 50' x 3/8" Wire Braided Hose and Adjustable Pressure Insulated Dual Lance



## Dual Fuel Powered Generator

### 5500-Watt Dual Fuel Portable Generator

SKU OSB CHM201505 **849<sup>99</sup>**

- Dual Fuel: Runs on Gasoline or Propane, Providing Up to 11 Hours of Run Time on Gasoline or 6.5 Hours on Propane
- Monitors Voltage, Frequency and Run-Time Hours



## Vises

### 4" Heavy Duty Bench Vise with Swivel Base

SKU 751643 24217 **74<sup>99</sup>**

- Polished Replaceable Steel Jaws
- Polished Anvil
- Permanent Pipe Jaws
- Full 360° Swivel Base
- Clamping Strength: 200 Lb.



### 6" Heavy Duty Bench Vise with Swivel Base

SKU 751654 24218 **159<sup>99</sup>**

- Replaceable Steel Jaws
- Permanent Pipe Jaws
- Full 360° Swivel Base
- Jaw Width: 6"
- Jaw Opening: 6"
- Throat Depth: 2.6"

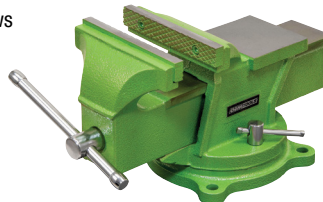

### 6-1/2" Professional Workshop Vise

SKU 394648 KTL64065

**264<sup>99</sup>**

- Jaw Width: 6-1/2"
- Jaw Opening: 9" Replaceable, Reversible Jaws



# SHOP EQUIPMENT

**Nitrous Key Program**

**NEW**

Pay It Off In 3 Months with Just 2 Keys/Day  
Add \$100,000 in Annual Revenue\*



## AutoProPAD G3 Evo with Complete Key Making System

SKU OSB  
NIT20402085

**Includes Starter Inventory — Coverage for the Most Popular Remotes/Remote Keys/Smart Keys**

- Complete Key System: Triton PLUS Auto Edition, AutoProPAD G3 Evolution, Remotes and Transponder Keys
- Fast Key/Remote Lookup by Year/Make/Model on NitrousKeys.com
- Triton PLUS: Decode, Duplicate and Cut Most High-Security Auto/Motorcycle Keys
- AutoProPAD G3: Key Programming for Common and Advanced Jobs
- 100+ Remotes/Remote Keys/Smart Keys for Popular Vehicle Makes
- Build-A-Key Components to Make Hundreds of Keys
- U.S.-Based Tech Support and Free Weekly Training



**8,299<sup>99</sup>**

REG. \$9,799.96

**SAVE OVER \$1,499**

When You Buy the Kit

## Triton PLUS Key Machine Automotive Edition

SKU OSB  
NIT20201002 **4,199<sup>99</sup>**

- Built For Auto: Cuts 99% Of Contemporary Automotive Keys
- Includes Automotive + Tibbe Jaws: TRJ1 and TRJ4
- Includes Dimple Cutters: Standard "C", MTL Inside "D", MTL Outside "E"
- Includes VW Cutter: 1.5 mm for HU162T and HU198T
- Duplicate Cut Keys by Code
- Fleets: Save Key Profiles in Memory, Easily Cut Lost Keys
- Engrave with Optional Jaw



## Triton PLUS Key Machine Ultimate Edition

SKU OSB  
NIT20201010 **5,899<sup>99</sup>**

- All-In-One: Automotive, Commercial, Residential Plus Engraving
- Includes All Jaws: TRJ1, TRJ2, TRJ3, TRJ4, TRJ5, TRJ6
- Adds Flip-Blade Creation Jaw for Xhorse/KeyDIY Blades
- Extra Consumables: Multiple Cutters/Decoders (Including VW 1.5 mm)
- Includes Mounting Brackets + 12V Car Power Adapter



To Confirm Price, Availability and Ordering Instructions on OSB, Call 901-300-4878 | \*Average 2 keys per day. Average charge for example is \$150.

# SHOP OWNERS, WE LOAN SPECIALTY TOOLS FOR SPECIAL JOBS!

## AUTOZONE® LOAN-A-TOOL® PROGRAM

### Over 90 Specialty Tools for Loan or Sale

We offer the most complete selection of tools for a variety of jobs, from steering and suspension, air conditioning, engine repair and more.

The best part is Loan-A-Tool® products are free to use! Leave a deposit at the store when you pick up the tool. When you're through just bring it back within 90 days, and we'll refund the deposit, or keep the tool.

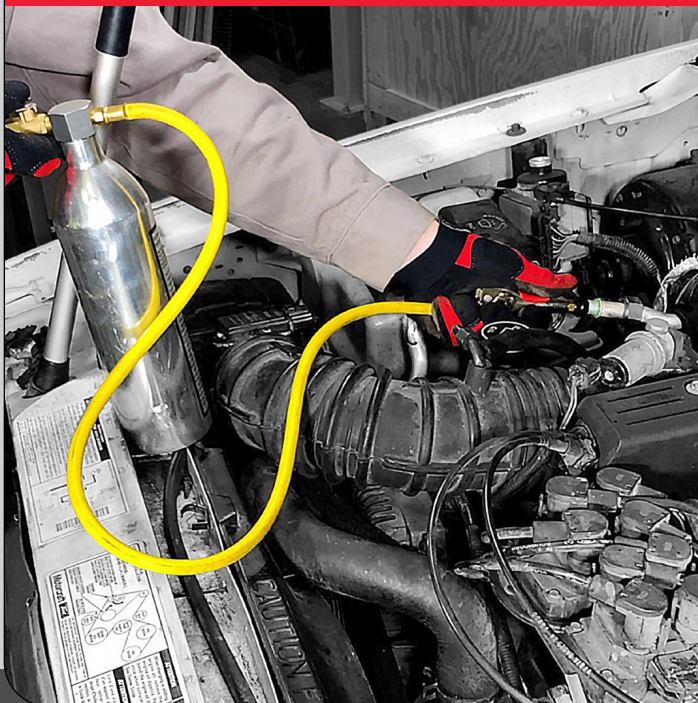

Ford Triton Spark Plug Porcelain Extractor Master Set



A/C Flush Kit



Fuel Injector Puller Kit - VW/Audi

See your Commercial Sales Manager for a complete list of loaner tools.

## Parts Storage

### Adjustable Bumper Stand

SKU OSB  
ATD6572 **259<sup>99</sup>**

- Holds Any Plastic Bumper Cover without Touching the Painted Surface
- Cover Can Be Rotated 90° to Ensure Proper Paint Coverage
- 5 Locking Positions
- Protective Rubber Boots Keep Critical Areas Free of Overspray
- 4 Industrial Grade Casters with 2 Locking for Zero Movement



### 3-Shelf Parts Cart

SKU OSB  
ATD6569 **384<sup>99</sup>**

- 3 Adjustable Shelves and Support Arms Provide Mobile Parts Storage
- Weight Capacity per Shelf: Bottom and Middle Shelf: 99 Lb. Top Shelf: 66 Lb.
- 6 S-Hooks
- (4) 4" Polyurethane Casters (2 Locking)



For Outside Buy/EPO, Call 901-300-4878

## Body Repair

### Fast Action Body Repair Kit

- Includes: Hydraulic Pump, Hydraulic Ram, 4 Extension Rods, a Rubber Ball Foot and a Duckbill Hydraulic Spreader
- Features a Faster Double-Action Hydraulic Pump
- Includes: Blow Mold Case

**4 Ton**  
SKU 301327  
24820 **279<sup>99</sup>**

**10 Ton**  
SKU 301328  
24821 **329<sup>99</sup>**



### 3 Piece Body Seam Splitter Set

SKU 265129  
25337 **39<sup>99</sup>**

- Includes: Straight, 30° Offset and 90° Angle Seam Splitters
- Tough Chrome Vanadium Steel
- GoThru® Shafts
- Shock Dampening Grip Provides Comfort



## Door Tools

### Door Spring Tool

SKU 447118  
25336 **11<sup>99</sup>**

- Quickly and Easily Remove or Install Door Hinge Springs
- Designed for GM Cars and Light Trucks



### Panel and Trim Clip Pliers

SKU 447154  
25930 **24<sup>99</sup>**

- Designed to Remove Panel Clips
- Constructed with a Durable Chrome Plated Alloy Steel
- 2-Step Tip Minimizes Risk of Clip Damage
- Ergonomic Comfort Grip Handles for Reduced User Fatigue



### Double Ended Clip Lifter

SKU OSB  
25308 **4<sup>99</sup>**

**NEW**

- Lifts Center Pins and Releases Push-Pin Retainers for Faster Removal
- Ideal for Door Panels, Upholstery Retainers and Interior Trim Service
- Works Great on Splash Shields, Wheel Well Liners and Underbody Panel Clips
- Thin Tips Slip Under Tight Clips to Help Reduce Scratches and Broken Fasteners



For OSB, Call 901-300-4878

## Hood Props



### Telescopic Hood Support

SKU 420337  
24211 **12<sup>99</sup>**

- Simple Turn Locks and Unlocks the Support in Place
- Rubber End Caps Protect Vehicle's Finish
- 21" When Closed and Almost 48" When Fully Extended
- Compact and Easy to Store, Easy to Use



↑  
**48" REACH**

### Hood Prop with Adapter

SKU 291352  
LIS46170 **84<sup>99</sup>**

- Includes a Support to Help Prevent Slipping
- 3 Piece Telescoping Shaft Locks in Any Position (Telescopes from 20" to 48-1/4")



### Universal Lift Support Clamp



SKU 191671  
25307 **14<sup>99</sup>**

- Aluminum Body and Brass Threads Prevent Damage to the Lift Support
- Red Color Serves as a Reminder to Remove the Clamp Before Closing



### 5 Piece Door Panel and Trim Remover Set

SKU 989263  
25312 **69<sup>99</sup>**

- Comprised of 3 Door Panels and 2 Trim Tools
- Textured, Comfortable Grips with Thumb Stop and Hanging Hole



### 6 Piece Door Panel and Trim Removal Set

SKU 003868  
25301 **44<sup>99</sup>**

- Includes: V-Notch Clip Remover, U-Notch Clip Remover, 2 Door Panel Removal Tools, C-Type Clip Removal Tool and Handle Clip Removal Tool



## Dent Puller



### Slide Hammer Dent Puller Set

SKU 265148  
25922 **149<sup>99</sup>**

- 12 Lb. Hammer, Slide Hammer Shaft, Slide Hammer Handle, Slide Hammer Adapter, Deep Hook, Short Hook, Door Edge Tool, Claw, Straight Driver, Hook and Chain, Sheet Metal Screw and Holder, Nose Piece with Screw
- Comes in a Blow Mold Case

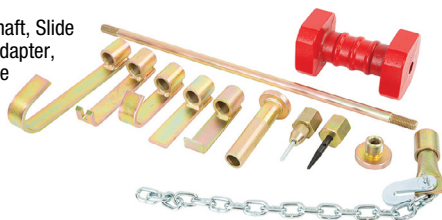

## Trim Tools

### Air Bag Release Tool for GM

SKU 191678  
25310 **10<sup>99</sup>**

- Fits Most GM Cars, Minivans and Light Trucks
- Tips are Tapered to Make Removal Easier



### Trim Fastener and Molding Remover Set

SKU 900801  
25314 **12<sup>99</sup>**

- Includes: 5 Tools for Easy Removal of Fasteners, Molding, Wheel Hubs and More
- For Use on Internal and External Vehicle Molding and Trim Fasteners



# WELDING & CUTTING

## Multi-Process

### 200A Multi MIG Synergic, TIG & Stick Welder (115-230VAC)

SKU **OSB**  
HSAHSW-6420 **2,499<sup>99</sup>**

- Welds MIG, DG TIG & Stick up to 3/8" Mild Steel
- 115V or 230V
- Inverter Rated 200A @ 35% DC
- 16 Program LCD Synergic Input
- Includes: Welder, MIG Gun, TIG Torch, Stick Cable, Earth Clamp Cable, Foot Pedal, 115V Adapter, Gas Regulator, Wire and TIG Kit
- Aluminum Spool Gun Ready (Not included)



For OSB, Call 901-300-4878



## 3-in-1

### Easy Weld 140 MP

SKU **1580962**  
FRN271 **549<sup>99</sup>**

- 3-in-1 Machine (Stick/MIG/TIG, TIG Torch not Included)
- Input: 120V | Output Voltage: 12-23V | Output Current Range: 43-110A
- Duty Cycle: Stick 30% @ 80A, MIG 30% @ 90A and TIG 30% @ 110A
- Includes: 10' MIG Gun, 8' Electrode Holder, 8' Ground Clamp, 20A-15A Adaptor and One Additional .030 in Contact Tip
- No Gas Required



### 190 MP MIG MIG/Stick/TIG Welder

SKU **1580957**  
FRN323 **1,499<sup>99</sup>**

- 4-in-1 Multi-Process Machine (MIG/Stick/Flux-Core/DC TIG, TIG Torch Not Included)
- Amperage Range (MIG): 120V: 30A-120A | 240V: 30A-200A
- Amperage Range (Stick): 120V: 10A-80A | 240V: 10A-190A
- Amperage Range (TIG): 120V: 10A-85A | 240V: 10A-190A
- Includes: 6' Power Cable, 8' Stick Electrode Holder, 8' Ground Cable and Clamp, 120V-240V Adapter Cord, 6' Gas Hose, 10' MIG Gun, Gas Regulator, Spare .030" and .035" Tips



## MIG Welder

### MIG and Flux-Core Welder (130 Amp)

SKU **OSB**  
HSAHSW-6213 **969<sup>99</sup>**

- Features Wire Speed and Power Settings by Material/Wire Thickness
- Rated Duty Cycle: 20% @ 130 Amps
- Includes: Inverter, Power Supply, Torch, Earth Clamp, Gas Regulator, Spool of .030" FluxCore Wire and Spool of .030" MIG Wire



For OSB, Call 901-300-4878



## Plasma Cutter

### Flex 30™ Plasma Cutter and Stick/TIG Welder

SKU **1580950**  
FRN320 **1,249<sup>99</sup>**

- Cut and Weld Up to 3/8" Thick Material with One Small, Powerful Machine
- Amperage Range (TIG): 120V: 10A-85A | 240V: 10A-160A
- Amperage Range (Stick): 120V: 10A-80A | 240V: 10A-160A
- Amperage Range (Plasma): 120V: 10A-20A | 240V: 10A-30A
- Includes: Forney Flex 30™ Plasma ST Machine, Additional Set of Consumables, 6' Power Cable, 8' Stick Electrode Holder, 8' Ground Cable and Clamp, 15' Plasma Torch and 120V-240V Adapter Cord (TIG Torch Not Included)



## Welding Accessories

### Multi-Purpose Welding Gloves

SKU **1544656**  
FRN53415 **29<sup>99</sup>**

- Size: Men's Large
- Ultra-Soft Premium Goatskin Leather
- Back of the Hand is Lined for Extra Defense from Heat, Palm is Unlined for Dexterity and Finger Control



### Welder Start-Up Kit

SKU **1544655**  
FRN377 **69<sup>99</sup>**

- Bandit Flip Front Welding Helmet with Fully Adjustable Ratcheting Headgear
- Leather Welding Gloves
- Chipping Hammer with Anti-Shock Handle
- Carbon Steel Scratch Brush



## Acetylene Torch

### Medium Duty Torch Kit

SKU **1580955**  
FRN1705 **299<sup>99</sup>**

- Cuts Up to 150 mm (5.91") and Welds Up to 9 mm (0.35") with Proper Tips
- Includes: 250-Series Regulators, 100-Series Torch Handle, 1350-Series Cutting Attachment, 0-3-101 Cutting Tip, W-1-0 Welding Tip, 1/4" (6.35 mm) X 12.5' (3.81 m) Twin Welding Hose with Fittings, #5 Goggles, Round Single Flint Striker, 13-Piece Tip Cleaner and Plastic Carry Case



## Welding Cart

### Portable Welding Cart

SKU **1544669**  
FRN332 **169<sup>99</sup>**

- Steel Construction
- Dimensions: 11-1/2" (W) x 27-1/2" (H)
- Weight Capacity: 90 Lb.
- Sleek Black Finish for a Professional Look



## Soldering

### Mechanics Butane Mini Torch

SKU 804655 **24<sup>99</sup>**  
24353

- Adjustable Flame Lights Upside Down
- Auto Ignition, Refillable
- Safety Lock When Not in Use



Butane Not Included

### Mechanics Butane Torch

SKU 802236 **25<sup>99</sup>**  
24354

- Heavy Duty Piezo Ignition with Strong Flame



Butane Not Included

### Professional 3-in-1 Butane Soldering Iron Kit

OEM TOOLS®

SKU 420338 **54<sup>99</sup>**  
24355

- Includes: Soldering Iron, Metal Tip Wicking Cup with Sponge, Solder Wire, Protective Tip Cap, Heat-Shrink Deflector, Chisel Point Tip, Anvil Solder Tip, Needle Tip and Hot Air/Soldering Tip
- Cable Free



### Professional 3-in-1 Butane Micro Torch Kit

SKU 420339 **43<sup>99</sup>**  
24356

- 3-in-1 Design Can Be Used as a Soldering Iron, Torch or Hot Air Blower without Iron Tip
- Micro Torch Kit Includes: Torch, Metal Tip Wicking Cup with Sponge, Heat-Shrink Deflector, Chisel Point Tip, Anvil Solder Tip, Needle Tip and Hot Air/Soldering Tip and Base
- Ideal for Use with Electrical Repair, Tin and Plastic Melting, Heat-Shrinkable Tubing, Auto Repair, Hobby Repair and Jewelry Repair
- Power Range: 30W to 125W



Butane Not Included

### Professional Soldering Gun Kit

SKU 1362003 **64<sup>99</sup>**  
24773

- Includes: Heavy Duty 230/150-Watt Soldering Gun, General Purpose Soldering Tip, Plastic Cutting Tip and 0.5 Oz. (14 g) Rosin Core Solder
- Reaches Max. Temperature of 937°F at Low Power
- Reaches Max. Temperature of 1400°F at High Power
- 120V, 150/230W, 60 Hz



## Welding Helmets

### Valor Auto-Darkening Welding Helmet

SKU 1544661 **119<sup>99</sup>**  
FRN55861

- 5.97 Sq. In. (3.62" x 1.65") Viewing Area
- 2 Optical Arc Sensors
- 1/1 1/2 Optical Clarity Rating
- UV/IR Coating to Reduce Scratching and Discoloration of the Lens
- DIN 9 to 13 Variable Shade Selection
- 1/25,000 Per Second Switching Speed



### Auto-Darkening Welding Helmet

OEM TOOLS®

SKU 362974 **89<sup>99</sup>**  
24357

- TIG Rated Variable Shade 9 to 13
- Viewing Area: 3.54" x 1.37"
- Battery Powered with Solar Assist
- Includes: Replacement Cover Lenses



### Auto-Darkening Welding Helmet with Grinding Function

OEM TOOLS®

SKU 347233 **106<sup>99</sup>**  
24358

- TIG Rated Variable Shade 9-13
- Variable Sensitivity and Delay Controls
- 2 Independent Arc Sensors
- Grinding Function
- Lens Darkening is 1/25,000
- Battery Powered with Solar Assist
- Includes: Replacement Cover Lenses
- Viewing Area: 3.62" x 1.65"



## Consumables

### E71T-GS Flux-Core Welding Wire 0.030" 2 Lb.

SKU 1544675 **31<sup>99</sup>**  
FRN42300

- Tensile Strength: 79,000 psi
- Weight: 2 Lb.
- Recommended Polarity: DCEN Straight
- No Shielding Gas Required



### ER70S-6 MIG Welding Wire 0.030" 10 Lb.

SKU 1544677 **59<sup>99</sup>**  
FRN42286

- Tensile Strength: 70,000 psi
- Weight: 10 Lb.
- Recommended Polarity: DCEP Reverse Polarity
- Required Shielding Gas: Argon/CO2



### E71T-GS Flux-Core Welding Wire 0.035" 2 Lb.

SKU 1544668 **31<sup>99</sup>**  
FRN42302

- Tensile Strength: 79,000 psi
- Weight: 2 Lb.
- Recommended Polarity: DCEN Straight
- No Shielding Gas Required



# HAND TOOLS

## Combo Wrench Sets

### RingStop® Reversible Ratcheting Wrench Set

- Patented RingStop® Design Makes One-Hand Use Easy
- Posi-Grip No-Slip® Design
- Jaw is 15° Offset
- Made with Chrome Vanadium Steel



### Flex Head Flare Nut Wrench Sets 5 Piece (SAE)



SKU 749849 **99<sup>99</sup>**  
22063

- 1/4" x 5/16", 3/8" x 7/16", 1/2" x 9/16", 5/8" x 11/16", 3/4" x 7/8"



### 6 Piece (Metric)

SKU 749930  
22064

- 9 mm x 11 mm, 10 mm x 12 mm, 13 mm x 14 mm, 15 mm x 17 mm, 16 mm x 18 mm, 19 mm x 21 mm

10" Width x 7.8" Depth

### 8 Piece Set (SAE)

SKU 803139  
23989 **129<sup>99</sup>**

- SAE Sizes: 5/16", 3/8", 7/16", 1/2", 9/16", 5/8", 11/16" and 3/4"



10" Width x 7.8" Depth

### 12 Piece Set (Metric)

SKU 803140  
23988 **189<sup>99</sup>**

- Metric Sizes: 8, 9, 10, 11, 12, 13, 14, 15, 16, 17, 18 and 19 mm



15" Width x 10" Depth

**BONUS VALUE: \$56.99**

### 8 Piece Go Thru Socket Set (SAE)

22979



With Purchase of 23989

Offer Good While Supplies Last Through June 30, 2026

**BONUS VALUE: \$56.99**

### 12 Piece Go Thru Socket Set (Metric)

22978



With Purchase of 23988

## Combo Wrench Sets

### 14 Piece (SAE)

SKU 802222 **179<sup>99</sup>**  
23993

- 1/4", 5/16", 3/8", 7/16", 1/2", 9/16", 5/8", 11/16", 3/4", 7/8", 15/16", 1", 1-1/16" and 1-1/8"

### 16 Piece (Metric)

SKU 802224 **199<sup>99</sup>**  
23994

- 6, 7, 8, 9, 10, 11, 12, 13, 14, 15, 16, 17, 18, 19, 21 and 22 mm



### 10 Piece Combination Wrench Set (Metric)

SKU 127920 **42<sup>99</sup>**  
22995

- Includes: 10 to 19 mm
- Posi-Grip No-Slip® Design Provides Off-Corner Loading for Greater Torque with More Socket-to-Fastener Contact
- Marked on All 4 Sides for Easy Identification

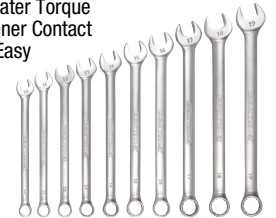

# JUMBO WRENCHES

Jumbo wrenches are made of high quality drop forged steel and are precision machined to prevent fastener damage.

Additional Individual Jumbo Wrenches Available on AZTOOL1.COM



Sets Include Roll-Up Storage Bag

SKU	Part #	Metric or SAE	Size	Price
338830	22100	SAE	1-1/16", 1-1/8", 1-1/4", 1-5/16", 1-3/8" and 1-7/16"	<b>109.99</b>
338833	22101	SAE	1-1/2", 1-5/8", 1-3/4", 1-7/8" and 2"	<b>149.99</b>
338852	22120	Metric	21 mm, 22 mm, 24 mm, 25 mm, 27 mm, 29 mm, 30 mm and 32 mm	<b>99.99</b>
338858	22121	Metric	33 mm, 34 mm, 35 mm, 36 mm, 40 mm, 42 mm, 46 mm, 50 mm	<b>169.99</b>

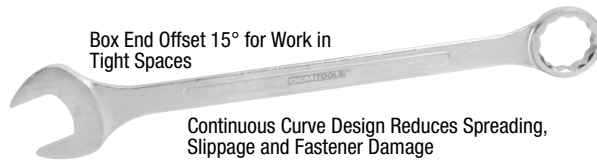

Box End Offset 15° for Work in Tight Spaces

Continuous Curve Design Reduces Spreading, Slippage and Fastener Damage

SKU	Part #	SAE Size	Price
338859	22102	1-1/16"	<b>14.99</b>
338864	22103	1-1/8"	<b>19.99</b>
338866	22104	1-1/4"	<b>22.99</b>
338868	22105	1-5/16"	<b>19.99</b>
338877	22106	1-3/8"	<b>21.99</b>
338890	22107	1-7/16"	<b>19.99</b>
338896	22108	1-1/2"	<b>21.99</b>
338898	22109	1-5/8"	<b>29.99</b>
338903	22110	1-3/4"	<b>39.99</b>
338935	22111	1-7/8"	<b>46.99</b>



## Jumbo Angle Wrench Set

### 6 Piece Jumbo Angle Head Wrench Set

SKU OSB 22113 **139<sup>99</sup>**

- Sizes: 1-3/8", 1-1/2", 1-5/8", 1-3/4", 1-7/8" and 2"



Includes Roll-Up Storage Bag  
For OSB, Call 901-300-4878



## Ratcheting Combination Wrenches

### 16 Piece 12 Pt. Ratcheting Combination Wrench Set (Metric)

SKU 213125 **209<sup>99</sup>**  
KDT9416

- Includes: 8, 9, 10, 11, 12, 13, 14, 15, 16, 17, 18, 19, 20, 21, 22 and 24 mm
- Ratcheting Box End Requires Only 5° to Move Fasteners
- 12 Point Design Providing More Positions to Engage the Fastener



## Wrench Extender

### Wrench Extender

SKU 1368628 **31<sup>99</sup>**  
22656

- Safely Provides Extra Leverage to Loosen Rusted Bolts, Jammed Fasteners or Over-Tightened Nuts
- Great for Use on Hard-to-Reach Fasteners



# HAND TOOLS

TO ORDER, contact your Commercial Sales Manager or go to [AutoZonePro.com](http://AutoZonePro.com)

HAND TOOLS

## Screwdrivers

### 19 Piece Screwdriver Set

SKU 1142325 **51<sup>99</sup>**  
73775

- Slotted: 3/32" x 1.5", 1/8" x 2.5", 3/16" x 4", 3/16" x 8" (Cabinet Tip), 1/4" x 1.5" (Stubby), 1/4" x 4", 1/4" x 6", 5/16" x 6", 3/8" x 8"
- Phillips: #0 x 1.5", #0 x 2.5", #1 x 3", #2 x 1.5" (Stubby), #2 x 4", #2 x 8", #3 x 6", #4 x 8"
- Offset: 3/16" x #1, 1/4" x #2
- Magnetic Tips Hold Fasteners in Place
- Square Shafts Can Be Used with Wrench for More Torque
- Hexagon Shaped Handles Prevent Roll Off
- Color Coded Fluting Defines Driver Type



GreatNeck



Impact Resistant Acetate Handle  
(Fluted for Better Grip)



### 8 Piece Mechanics Screwdriver Set

SKU 802208 **74<sup>99</sup>**  
23999

- EVA Tray with Custom Cut Contrast Soft Foam and Sizes Marked for Easy Identification, Designed to Fit Securely in a Cabinet or Tool Box
- Features a Hard Chrome™ Finish, an Easy-to-Clean Smooth Satin Finish That Won't Show Prints and Keeps Rust Away
- Custom Cut of the Tool is a Hi-Vis Green Making it Visible if a Tool is Missing
- Slotted: 1/4" x 1-1/2", 3/16" x 3", 1/4" x 4", 5/16" x 6" and 3/8" x 8"



OEM TOOLS



### 20 Piece Screwdriver Set

SKU OSB **19<sup>99</sup>**  
92080

- Chrome Vanadium Steel Shaft for Strength and Durability
- Precision Ground Sandblasted Tip
- Highest Quality Acetate Handle
- Slotted: 3/32" x 2", 1/8" x 2", 3/16" x 4", 1/4" x 1-1/2", 1/4" x 4", 1/4" x 6"
- Phillips: #00 x 1-1/2", #0 x 2", #1 x 3", #2 x 4", #2 x 6", #2 x 1-1/2"
- Star: T15, T20
- Square: #2
- (1) Offset Screwdriver
- 4 Piece Hook and Pick Set

GreatNeck



For OSB, Call 901-300-4878

## Star Screwdrivers

### 5 Piece Star Screwdriver Set

SKU 1142630 **16<sup>99</sup>**  
73721

- Star (T10 x 4", T15 x 4", T20 x 4", T25 x 5", T30 x 6")
- Magnetic Tips Hold Fasteners in Place
- Hexagon Shaped Handles Prevent Roll Off

GreatNeck



## Gasket Scraper Set

### 3 Piece Gasket Scraper Set

SKU 1069069 **24<sup>99</sup>**  
26501

- Includes: 3/4", 1" and 1-1/2" Gasket Scrapers

OEM TOOLS



## Long Reach Screwdrivers

OEM TOOLS

- High Performance Hex Shaped Shaft for More Torque and Less Flex
- Precision Machined and Sand Blasted Tips That Reduce Cam-Out
- Durable Ergonomic Handles are Made of Hardened Resin

### 5/16" x 20" Slotted Screwdriver

SKU 1142473 **24<sup>99</sup>**  
22555

### #2 x 20" Phillips Screwdriver

SKU 1142485 **13<sup>99</sup>**  
22574

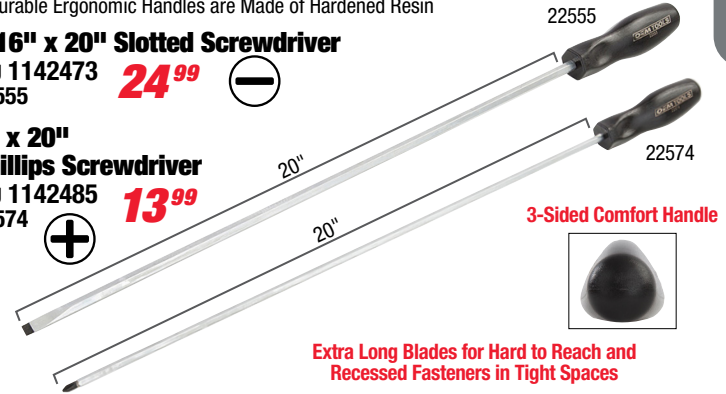

22555

22574

3-Sided Comfort Handle



Extra Long Blades for Hard to Reach and Recessed Fasteners in Tight Spaces

## Hex Key Sets

OEM TOOLS

Ball-End Hex Keys Work at Angles Up to 25°



S2  
STEEL



### Extra Long Reach Hex Key Sets

- Color-Coded for Easy Identification

### 27 Piece Metric, SAE and Star

SKU 1209375 **74<sup>99</sup>**  
24299

- Metric: 1.5 to 10 mm (9 Pc.)
- SAE: 1/16" to 3/8" (9 Pc.)
- Star: T10 to T50 (9 Pc.)

### 18 Piece Metric and SAE

SKU 479170 **36<sup>99</sup>**  
24298

- Metric: 1.5 to 10 mm (9 Pc.)
- SAE: 1/16" to 3/8" (9 Pc.)



### Corrosion Resistant Hex Key Sets

- Manganese Phosphate Corrosion Resistance

### 35 Piece Metric, SAE and Star

SKU 1168819 **39<sup>99</sup>**  
24249

- Metric: 1.27 to 10 mm (13 Pc.)
- SAE: 3/64" to 3/8" (13 Pc.)
- Star: T10 to T50 (9 Pc.)

### 26 Piece Metric and SAE

SKU 1168833 **23<sup>99</sup>**  
24248

- Metric: 1.27 to 10 mm (13 Pc.)
- SAE: 5/64" to 3/8" (13 Pc.)



Prices subject to change without notice. Prices do not include applicable taxes, vehicles, tires, rims, installation or optional equipment as shown. Please do not return purchases to the store. For information regarding warranty, repair, or any questions or concerns, call 901-300-4878.

AZG0226

# HAND TOOLS

## Mechanics Set

### 64 Piece 1/4" Drive Set (Metric)

SKU 020788 **119<sup>99</sup>**  
23997

- Shallow Sockets, 6 Pt: 4 to 15 mm
- Deep Sockets, 6 Pt: 4 to 15 mm
- Drive Wobble Straight Extension
- Bit Extension Bars: 6" and 10"
- Ratchet Screwdriver
- Universal Joint
- Ratchet
- 28 Bits



20" Width x 8" Depth

OEM TOOLS



## Ratchet and Socket Set

OEM TOOLS

### 26 Piece 1/2" Drive Ratchet and Socket Set

SKU 591154 **129<sup>99</sup>**  
23995

- Includes: (21) 6 Pt. Metric and SAE Sockets, (1) 1/2" Dr. Extension Bar 3", (1) 1/2" Dr. Extension Bar L6, (1) 1/2" Swivel U-Joint, and (1) 1/2" Dr. Regular Ratchet

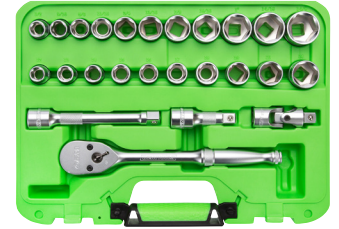

## Universal Joints

OEM TOOLS

### 1/4" Drive

SKU 081225 **9<sup>99</sup>**  
22520



(Style May Vary)

### 1/2" Drive

SKU 081227 **13<sup>99</sup>**  
22522

### 3/8" Drive

SKU 081226 **10<sup>99</sup>**  
22521

## Socket Adapters

### 3 Piece Low-Profile Adapter Set

SKU 818570 **29<sup>99</sup>**  
22535

- CR-V Steel for Strength
- Get into Tighter Spaces
- Includes: 1/4" F x 3/8" M, 3/8" F x 1/2" M, and 1/2" F x 3/4" M



## Adapters

- Hard Chrome™ Finish is Easy to Clean and Will Keep Away Rust



22534

HARD CHROME™ FINISH

OEM TOOLS

SKU	Part #	Drive	Price
81228	22530	1/2" F x 3/4" M	<b>6.99</b>
81229	22531	1/2" F x 3/8" M	<b>6.99</b>
81230	22532	3/8" F x 1/2" M	<b>7.99</b>
81232	22533	3/8" F x 1/4" M	<b>6.99</b>
81233	22534	1/4" F x 3/8" M	<b>7.99</b>

## Socket Sets

- Posi-Grip No-Slip®
- Off Corner Loading for Greater Torque
- Knurling Position for Best Finger Gripping

- Chamfered Ends Allow the Socket to Easily Slip Over the Bolt Head
- Deep Marking for Easy Identification



### 1/4" Drive Socket Sets

#### 10 Piece (SAE)

SKU 127786 **13<sup>99</sup>**  
22952

- 3/16" to 9/16"

#### 12 Piece (Metric)

SKU 127836 **21<sup>99</sup>**  
22950

- 5 mm to 15 mm

#### 10 Piece Deep (SAE)

SKU 1414402 **26<sup>99</sup>**  
22953A

- 3/16" to 9/16"

#### 12 Piece Deep (Metric)

SKU 127772 **31<sup>99</sup>**  
22951

- 5 to 15 mm



### 10 Piece 1/4" Deep (SAE)

SKU 850056 **39<sup>99</sup>**  
23985

- Includes: 3/16" to 9/16"

### 12 Piece 1/4" Deep (Metric)

SKU 850510 **39<sup>99</sup>**  
23986

- Includes: 5 mm to 15 mm



10" Width x 4" Depth

OEM TOOLS



### 3/8" Drive Socket Sets

#### 11 Piece (SAE)

SKU 127798 **26<sup>99</sup>**  
22956

- 1/4" to 7/8"

#### 12 Piece (Metric)

SKU 127794 **35<sup>99</sup>**  
22954

- 8 mm to 19 mm

#### 11 Piece Deep (SAE)

SKU 127803 **43<sup>99</sup>**  
22957

- 1/4" to 7/8"

#### 12 Piece Deep (Metric)

SKU 127797 **40<sup>99</sup>**  
22955

- 8 mm to 19 mm



### 12 Piece 3/8" Deep Socket Set (Metric)

SKU 103402 **40<sup>99</sup>**  
23981

- Includes: 8 mm to 19 mm



10" Width x 7" Depth



### 1/2" Drive Socket Sets

#### 11 Piece (SAE)

SKU 127812 **46<sup>99</sup>**  
22960

- 1/2" to 1-1/8"

#### 10 Piece (Metric)

SKU 127807 **29<sup>99</sup>**  
22958

- 10 mm to 19 mm

#### 11 Piece Deep (SAE)

SKU 127846 **64<sup>99</sup>**  
22961

- 1/2" to 1-1/8"

#### 10 Piece Deep (Metric)

SKU 127809 **40<sup>99</sup>**  
22959

- 10 mm to 19 mm



### 24 Piece 3/8" Drive Socket Set (Metric)

SKU 127868 **54<sup>99</sup>**  
22963

- Includes: 8-19 mm (Deep) and 8-19 mm (Shallow)

### 22 Piece 3/8" Drive Socket Set (SAE)

SKU 127869 **74<sup>99</sup>**  
22962

- Includes: 1/4" to 7/8" (Deep); 1/4" to 7/8" (Shallow)



Prices subject to change without notice. Prices do not include applicable taxes, vehicles, tires, rims, installation or optional equipment as shown. Please do not return purchases to the store. For information regarding warranty, repair, or any questions or concerns, call 901-300-4878.

# HAND TOOLS

TO ORDER, contact your Commercial Sales Manager or go to [AutoZonePro.com](http://AutoZonePro.com)

HAND TOOLS

## Ratchets

### HARD CHROME™ FINISH OEM TOOLS®

- 36 Teeth with 10° Arc Motion for Precision and Strength
- Reversing Lever Allows a Forward and Reverse in One-Hand Action
- Sealed to Keep Dirt and Debris Out of Head
- Compact Head Designed to Get into Tight Spaces

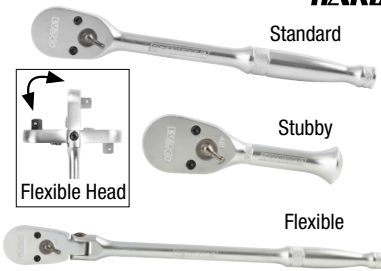

SKU	Part #	Type	Drive	Length	Price
081298	22900	Standard	1/4"	4-1/4"	22.99
177728	22911	Standard	3/8"	8"	29.99
177768	22920	Standard	1/2"	10"	43.99
177702	22910	Stubby	3/8"	4"	27.99
081301	22901	Flexible	1/4"	6"	29.99
177730	22912	Flexible	3/8"	11-1/2"	35.99
177769	22921	Flexible	1/2"	17-1/2"	59.99

## Extensions

### OEM TOOLS®

- Chamfered Ends for Positive Engagement with Drive Tools
- Knurled Shank for Easy Fingertip Turning
- Milled Ends Provide a Solid Connection

SKU	Part #	Drive	Length	Price
081213	22481	1/4"	4"	2.99
081215	22482	1/4"	6"	7.99
081218	22483	1/4"	11"	10.99
081219	22490	3/8"	1-3/4"	5.99
081220	22491	3/8"	4"	8.99
306326	22492	3/8"	6"	5.99
306287	22494	3/8"	10"	7.99
306279	22495	3/8"	18"	11.99
081212	22480	1/2"	2"	4.99
081221	22500	1/2"	3"	10.99
081223	22501	1/2"	6"	9.99
081224	22502	1/2"	10"	11.99

## Flex Head Breaker Bars

### OEM TOOLS®

- Special Alloy Steel, Heat-Treated to Provide Durability
- 180° Flex Head Provides Leverage at Desired Angle for Hard-to-Reach Applications

SKU	Part #	Drive	Length	Price
081302	22913	3/8"	11-9/16"	24.99
OSB	22922	1/2"	18"	31.99
750437	22923	1/2"	24"	35.99



For OSB, Call 901-300-4878

## Breaker Bar



### 1/2" Drive 24" Breaker Bar with Flex Head

SKU OSB 38005 **24.99**



For OSB, Call 901-300-4878

## Spiral Drive Set

### OEM TOOLS®

### 5 Piece Spiral Drive Bit Set

SKU 802234 **29.99**  
22975

- Sizes: MTS0, MTS1, MTS2, MTS3 and MTS4
- 3/8" Drive

- Services New Fasteners Found on Many GM, Chrysler, BMW and Fiat Vehicles of the Mid-2000 and Later Model Range Including Bolts That Secure the Bell Housing to the Transmission on GM 4L60 Transmissions



## Triple Square Bit Sets

- Use on European Vehicles Like BMW, Mercedes, VW, Audi and Porsche
- Heat-Treated Alloy Steel Bits to Reduce Premature Wear
- Reinforced Chrome Vanadium Steel Sockets to Increase Turning Power

- Fully Refined Hard Chrome Plated Finish and Zinc Phosphate Bits Treatment to Prevent Rust and Corrosion
- Meets and Exceeds ANSI Standards

### OEM TOOLS®

### 10 Piece Extra Long XZN Triple Square Spline Bit Socket Set

SKU 1368626 **59.99**  
23519

- Sizes Included: M4, M5, M6, M8, M9, M10, M12, (Tamper-Proof) M14, M16, M18
- Socket Length: 3.93"



### 10 Piece Magnetic Long Triple Square Bit Socket Set

SKU 1313567 **59.99**  
23907

- Sizes Included: (1/4" Drive) M4, M5, M6; (3/8" Drive) M8, M9, M10, M12, M14; (1/2" Drive) M16, M18
- Socket Length: 3.93"



### 9 Piece Triple Square Bit Set

SKU 191052 **29.99**  
25953

- 1/4" Drive: M4, M5 and M6 (Length: 37 mm)
- 3/8" Drive: M8, M10 and M12 (Length: 48 mm)
- 1/2" Drive Tamper-Proof: M14, M16 and M18 (Length: 55 mm)



### 10 Piece Triple Square Bit Socket Set

SKU 1368630 **31.99**  
22711

- Sizes Included: M4, M5, M6, M8, M9, M10, M12, (Tamper-Proof) M14, M16, M18
- Comes Enclosed in Blow Mold Case for Easy Identification and Storage



### 10 Piece Magnetic Triple Square Bit Socket Set

SKU 1368615 **49.99**  
23906

- Powerful Magnetic Bits to Prevent the Loss of Nuts, Bolts and Fasteners
- Comes Enclosed in Blow Mold Case for Easy Identification and Storage
- Sizes Included: (1/4" Drive) M4, M5, M6; (3/8" Drive) M8, M9, M10, M12, M14; (1/2" Drive) M16, M18



Prices subject to change without notice. Prices do not include applicable taxes, vehicles, tires, rims, installation or optional equipment as shown. Please do not return purchases to the store. For information regarding warranty, repair, or any questions or concerns, call 901-300-4878.

AZG0226

# HAND TOOLS

- Constructed for Professionals with Superior Materials for Increased Torque and Hardness
- Heat-Treated S2 Steel Bits to Reduce Premature Wear

- Reinforced Chrome Vanadium Steel Sockets for Durability and Improved Finish
- Fully Refined Hard Chrome Plated Finish and Zinc Phosphate Bits Treated to Prevent Rust and Corrosion



## Hex Sets

### 26 Piece Master Hex Bit Set

SKU 802219 **51<sup>99</sup>**  
23990

- Includes: 1/4" Drive Sizes: 1/8" to 7/32" and 2.5 to 5 mm, 3/8" Drive Sizes: 1/4" to 11/32" and 6 to 9 mm, 1/2" Drive Sizes: 3/8" to 5/8" and 10 to 19 mm



### 12 Piece Long (SAE)

SKU 1282747 **55<sup>99</sup>**  
23563

- 1/4" Drive: 1/16", 5/64", 3/32", 7/64" and 1/8"
- 3/8" Drive: 9/64", 5/32", 3/16", 7/32", 1/4", 5/16" and 3/8"

### 12 Piece Long (Metric)

SKU 1282757 **53<sup>99</sup>**  
23538

- 1/4" Drive: 2 mm, 2.5 mm, 3 mm, 4 mm and 5 mm
- 3/8" Drive: 5.5 mm, 6 mm, 7 mm, 8 mm, 9 mm, 10 mm and 12 mm

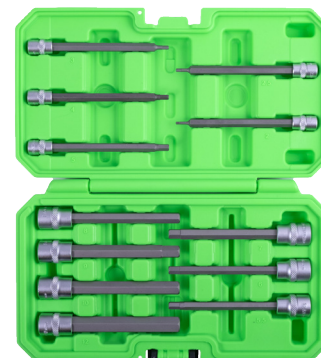

### 12 Piece Magnetic (SAE)

SKU 1282759 **44<sup>99</sup>**  
23900

- 1/4" Drive: 1/16", 5/64", 3/32", 7/64" and 1/8"
- 3/8" Drive: 9/64", 5/32", 3/16", 7/32", 1/4", 5/16" and 3/8"

### 12 Piece Magnetic (Metric)

SKU 1282804 **43<sup>99</sup>**  
23901

- 1/4" Drive: 2 mm, 2.5 mm, 3 mm, 4 mm, 5 mm and 5.5 mm
- 3/8" Drive: 6 mm, 7 mm, 8 mm, 9 mm, 10 mm and 12 mm

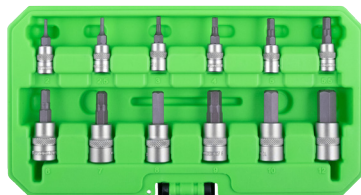

### 12 Piece Magnetic Long (SAE)

SKU 1282807 **57<sup>99</sup>**  
23902

- 1/4" Drive: 1/16", 5/64", 3/32", 7/64", 1/8"
- 3/8" Drive: 9/64", 5/32", 3/16", 7/32", 1/4", 5/16" and 3/8"

### 12 Piece Magnetic Long (Metric)

SKU 1282737 **56<sup>99</sup>**  
23903

- 1/4" Drive: 2 mm, 2.5 mm, 3 mm, 4 mm and 5 mm
- 3/8" Drive: 5.5 mm, 6 mm, 7 mm, 8 mm, 9 mm, 10 mm and 12 mm

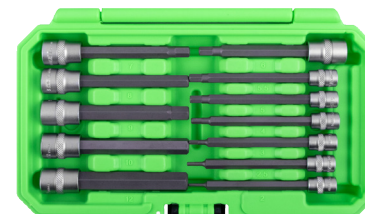

### 1/2" Drive Hex Bit Set (Metric)

SKU OSB **9<sup>99</sup>**  
25417

- Sizes: 12, 14 and 17 mm
- Use on Transmission and Differential Drain Plugs



For OSB,  
Call 901-300-4878



### 1/2" Drive SAE Hex Bit Socket Set (6 Piece)

SKU 1168826 **34<sup>99</sup>**  
22999

- Includes 9/16", 5/8", 11/16", 3/4", 13/16" and 7/8"
- Tempered Chrome Vanadium Steel with a Plated Finish for Long Life



### 1/2" Drive Metric Hex Bit Socket Set (7 Piece)

SKU 1168830 **39<sup>99</sup>**  
22998

- Includes: 13, 14, 15, 17, 19, 21 and 22 mm



### 9 Piece Hex Bit Set (Metric)

SKU 127903 **20<sup>99</sup>**  
22983

- Includes: 1/4" Drive 2, 2.5, 3, 4 mm and 3/8" Drive 5, 6, 7, 8, 10 mm
- Knurling Position is Optimized for Best Finger Gripping Position



### 7 Piece Hex Bit Set (SAE)

SKU 127904 **19<sup>99</sup>**  
22982

- 3/8" Drive: 5/16" and 3/8"
- 1/2" Drive: 7/16", 1/2", 9/16", 5/8" and 3/4"



### 12 Piece Hex Bit Set (SAE)

SKU 127905 **26<sup>99</sup>**  
22984

- Includes: (1/4" Drive) 1/16", 5/64", 3/32", 7/64", 1/8"; (3/8" Drive) 9/64", 5/32", 3/16", 7/32", 1/4", 5/16", 3/8"
- Knurling Position is Optimized for Best Finger Gripping Position



## Multi-Drive Sets

### 35 Piece Multi-Drive Star Socket Set

SKU 802217 **67<sup>99</sup>**  
23991

- 1/4" Drive Star: T10, T15, T20, T25, T27 and T30
- 1/4" Drive Tamper-Proof Star: T7, T8, T9, T10, T15, T20, T25 and T30
- 1/4" Drive Female Star: E4, E5, E6, E7 and E8
- 3/8" Drive Tamper-Proof Star: T40, T45, T50 and T55
- 3/8" Drive Star: T40, T45, T47, T50 and T55
- 3/8" Drive Female Star: E10, E12, E14 and E16
- 1/2" Drive Star: T60 and T70
- 1/2" Drive Female Star: E18



10-3/4" Width x 5-3/4" Depth



### 44 Piece Multi-Drive Star and Bit Socket Set

SKU 802206 **57<sup>99</sup>**  
23992

- 1/4" Bit Holder
- 1/4" Hex Drive Tamper-Proof Star Bits: T7, T8, T9, T10, T15, T20, T25, T27, T30
- 1/4" Hex Drive Star: T10, T15, T20, T25, T27 and T30
- 3/8" Drive Star: T40, T45, T47, T50, T55 and T60
- 3/8" Drive Metric Hex: 2, 2.5, 3, 4, 5, 6, 7, 8 and 10 mm
- 3/8" Drive SAE Hex: 1/8", 5/32", 3/16", 7/32", 1/4", 5/16" and 3/8"
- 3/8" Drive Phillips: #1, #2 and #3
- 3/8" Drive Slotted: 3/16", 1/4" and 5/16"



10-3/4" Width x 5-3/4" Depth



## Star Sets

### 13 Piece Tamper-Proof Set

SKU 1282735 **29<sup>99</sup>**  
22710

- 1/4" Drive: T8, T10, T15, T20, T25, T27 and T30
- 3/8" Drive: T40, T45, T47, T50 and T55
- 1/2" Drive: T60



### 13 Piece Star Bit Socket Set

SKU 1282806 **27<sup>99</sup>**  
22977

- 1/4" Drive: T8, T10, T15, T20, T25, T27 and T30
- 3/8" Drive: T40, T45, T47, T50 and T55
- 1/2" Drive: T60



### 35 Piece Master Star Bit Set

SKU 466622 **39<sup>99</sup>**  
25951 REG. 59.99

- 1/4" Drive Star: T8 to T30
- 1/4" Drive Tamper-Proof Star: T7, T8, T9, T10, T15, T20, T25 and T30
- 1/4" Drive Female Star: E4, E5, E6, E7 and E8
- 3/8" Drive Star: T40, T45, T47, T50 and T55
- 3/8" Drive Tamper-Proof Star: T40, T45, T50 and T55
- 3/8" Drive Female Star: E10, E12, E14 and E16
- 1/2" Drive Star: T60



Offer Good Through June 30, 2026

### 13 Piece Magnetic Set

SKU 1267957 **46<sup>99</sup>**  
23904

- 1/4" Drive: T8, T10, T15, T20, T25, T27 and T30
- 3/8" Drive: T40, T45, T47, T50, T55 and T60

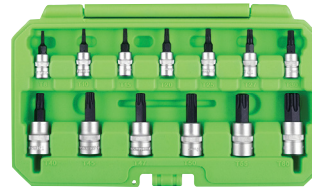

### 13 Piece Magnetic Long Set

SKU OSB **59<sup>99</sup>**  
23905

- 1/4" Drive: T8, T10, T15, T20, T25, T27 and T30
- 3/8" Drive: T40, T45, T47, T50, T55 and T60



For OSB, Call 901-300-4878

### 13 Piece Extra Long Set

SKU 1282758 **72<sup>99</sup>**  
23680

- 1/4" Drive: T8, T10, T15, T20, T25, T27 and T30
- 3/8" Drive: T40, T45, T47, T50, T55 and T60

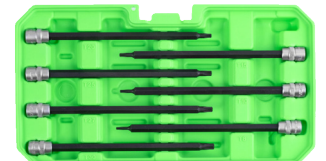

Ratchet Not Included

### 11 Piece Tamper-Proof Star Set

SKU 127872 **24<sup>99</sup>**  
22972

- Includes: (1/4" Drive) T8, T10, T15, T20, T25, (3/8" Drive) T27, T30, T40, T45, T47, T50
- Knurling Position is Optimized for Best Finger Gripping Position
- Black Oxide Finish Indicates Star Drivers
- Chamfered Ends Allow the Socket to Easily Slip Over the Bolt Head
- Comes with Storage Rail



### 12 Piece Tamper-Proof Star Set

SKU 127870 **24<sup>99</sup>**  
22971

- Includes: (1/4" Drive) T8, T10, T15, T20, T25, (3/8" Drive) T27, T30, T40, T45, T47, T50, T55
- Knurling Position is Optimized for Best Finger Gripping Position – Go Ahead and Put On Serious Torque, it Won't Slip
- Black Oxide Finish Indicates Star Drivers
- Chamfered Ends Allow the Socket to Easily Slip Over the Bolt Head
- Comes with Storage Rail



### 13 Piece Stubby Star Drive Set

SKU 447157 **39<sup>99</sup>**  
24293

- Includes Sizes: T7, T8, T9, T10, T15, T20, T25, T27, T30, T40, T45, T47 and T50
- 3/4" Overall Length Designed for Limited Access Applications
- Clearly Etched Sizes for Easy Identification
- Light Aluminum Rail with Adjustable Studs



# HAND TOOLS

## Pro Series Pliers Sets



### 3 Piece Groove Joint Pliers Set

SKU 662761 **49<sup>99</sup>**  
22648

- Sizes: 8", 10" and 12"
- Gripping Capacity: 8" (1.25"), 10" (1.80"), 12" (2.25")



### 3 Piece Mechanics Pliers Set

SKU 662748 **44<sup>99</sup>**  
22647

- Pliers and Sizes: 7" Diagonal Pliers, 8" Linesman Pliers, 10" Speed-Fit Pliers



## Locking Pliers

- For Clamping and Gripping in Tight Spaces
- Constructed with Heat-Treated Alloy Steel
- Precision-Machined Jaws Feature Hardened Teeth to Provide a Sure Grip from Any Angle
- Instant Locking and Release Mechanism for Improved Control
- Nickel Chrome Plated to Resist Rust

### 7 Piece Locking Pliers Set

SKU 012622 **99<sup>99</sup>**  
23987

- Sizes: 4", 5", 7", 10" Curved Jaw and 4", 6", 9" Long Nose



15" Width x 10" Depth



23987

#### Curved Jaw



22635

#### Long Nose



22637

#### Chain



22642

#### C-Clamp



22641

SKU	Part #	Type	Size	Price
081256	22635	Curved Jaw	4"	<b>9.99</b>
081257	22636		5"	<b>12.99</b>
081261	22638		7"	<b>13.99</b>
081263	22640		10"	<b>19.99</b>
081260	22637	Long Nose	6-1/2"	<b>9.99</b>
081262	22639		9"	<b>15.99</b>
081267	22642	Chain	19"	<b>20.99</b>
081265	22641	C-Clamp	11"	<b>22.99</b>

## Extended Reach Pliers



### 16" Long Reach Long Nose Pliers Set - 3 Piece Set

SKU 1142915 **39<sup>99</sup>**  
22660

- Includes: Straight, 45° and 90° Long Nose Pliers
- Features Strong Flush Rivets That Won't Get Caught When Working in Tight Spaces
- Constructed with Heat-Treated Drop-Forged Steel Chrome Plated to Resist Rust and Corrosion
- Double Dipped Handles for Added Comfort and Secure Grip



### 11" Long Reach Long Nose Pliers



- Constructed with Durable Heat-Treated Alloy Steel
- Precision-Machined Jaws Provide Improved Grip
- TecReady Grip Handles Reduce User Fatigue
- Nickel Chrome Plated to Resist Rust

#### Straight

SKU 081249 **15<sup>99</sup>**  
22621

45°  
SKU 081250 **13<sup>99</sup>**  
22622

Duck Bill  
SKU 213108 **12<sup>99</sup>**  
22644



(Color May Vary)

### 11" Hose Gripper Pliers Set (3 Piece)

SKU 94811 **74<sup>99</sup>**  
L311L



- Sizes: 5/16", 1/2" and 3/4" Constructed with Durable Drop Forged Steel
- Specialized Jaw will Securely Grip Cooling System, Fuel and Vacuum Lines without Damaging the Hose
- Heavy Duty Double-Dipped Synthetic Grip Handles to Minimize Slippage and Reduce User Fatigue
- Chrome Plated to Resist Rust



## Mechanic's Pliers

- Precision-Machined Jaws Provide Improved Grip
- TecReady Grip Handles Reduce User Fatigue
- Nickel Chrome Plated to Resist Rust



#### Diagonal Pliers



#### Groove Joint Pliers



#### Linesman Pliers



#### Long Nose Pliers with Side Cutter



SKU	Part #	Type	Size	Color	Price
081240	22614	Diagonal	6-1/2"	Green	<b>25.99</b>
081241	22615	Diagonal	7-1/2"	Red	<b>15.99</b>
081245	22617	Groove Joint	6"	Red	<b>8.99</b>
081246	22618		8"	Red	<b>11.99</b>
081247	22619		10"	Red	<b>16.99</b>
081252	22624		16"	Red	<b>69.99</b>
081243	22616	Linesman	8"	Red	<b>31.99</b>
081237	22612	Long Nose Pliers with Side Cutter	6"	Red	<b>15.99</b>
081239	22613		8"	Red	<b>15.99</b>

## X-Type Pliers



### 2 Piece 13" Long Nose Pliers Set

SKU 213127 **59<sup>99</sup>**  
22632

- Includes: 45° and Straight Extended Reach Pliers

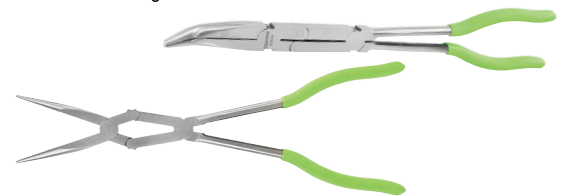

### 13" Long Nose Pliers

- Serrated Jaws for Precision Gripping

**Straight**  
SKU 213135 **32<sup>99</sup>**  
22633

**45°**  
SKU 213117 **32<sup>99</sup>**  
22634



# HAND TOOLS

TO ORDER, contact your Commercial Sales Manager or go to [AutoZonePro.com](http://AutoZonePro.com)

HAND TOOLS

## Punch Set

OEM TOOLS®

### 16 Piece Punch and Chisel Set

SKU 914624  
25515 **48<sup>99</sup>**

- Includes: 5 Taper Punches, 5 Pin Punches, 2 Center Punches, 3 Cold Chisels and 1 Chisel Gauge



## Ball Peen Hammers

GreatNeck

- Hickory Handle Clear Coat Protects Against Rust
- Drop Forged Steel for Strength and Durability
- Steel Wedge Enforced Head for Extra Security



SKU	Part #	Size	Price
1142353	BP12	12"	<b>15.99</b>
OSB	BP16	16"	<b>17.99</b>
1142643	BP24	24"	<b>39.99</b>

For OSB, Call 901-300-4878

## Pry Bars

OEM TOOLS®

### 3 Piece Pry Bar Set

SKU 626114  
24433 **41<sup>99</sup>**

- Lengths Included: 12", 18" and 24"
- 3 Sided Handle for Secure Grip and Comfort
- Solvent Resistant and Easy to Clean

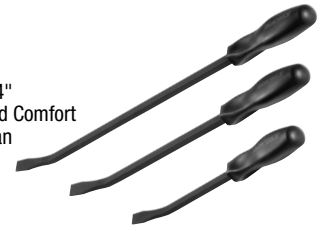

### 36" Pry Bar

SKU 695126  
24435 **37<sup>99</sup>**

- Unique Ergonomically Designed 3-Sided Handle for Secure Grip and Comfort
- Handles Made with Hardened Resin That is Solvent Resistant and Easy-to-Clean
- Forged and Hardened 5/8 In. Square Stock for Incredible Strength



## Dead Blow Hammers

OEM TOOLS®

### 3 Piece Dead Blow Hammer Set

SKU 900804  
25517 **35<sup>99</sup>**

- Soft Rubber Handles for Non-Slip Grip
- Steel Shot Filled for More Force
- Non-Spark Material Used

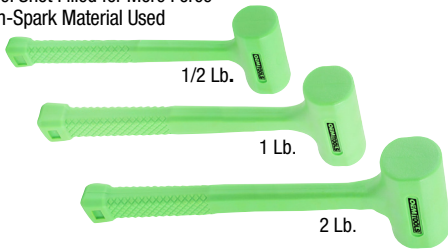

### 2 Lb. Dead Blow Hammer

SKU OSB  
617 **39<sup>99</sup>**

GreatNeck

- Sand-Filled Head, One-Piece Composite Construction for Safety and Durability
- Weight Loaded Material for Extra Hitting Power with Less Bounce
- Will Not Mar Surfaces

For OSB, Call 901-300-4878



## Adjustable Wrenches

OEM TOOLS®

- Made with Special Alloy Steel, Heat-Treated
- Deep Marking for Easy Identification
- Nickel Chrome Plated Steel Won't Rust
- Flat Profile is Comfortable in Hands



SKU	Part #	Size	Price
081268	22650	4"	<b>15.99</b>
081269	22651	6"	<b>17.99</b>
081271	22652	8"	<b>19.99</b>
081273	22653	10"	<b>24.99</b>
081274	22654	12"	<b>34.99</b>
081297	22655	15"	<b>59.99</b>

## Pipe Wrench

GreatNeck

- Precision Milled Moveable Jaws
- Perfectly Balanced



APW24

SKU	Part #	Material	Size	Price
965845	APW14	Aluminum	14"	<b>34.99</b>
965848	APW18		18"	<b>37.99</b>
972768	APW24		24"	<b>49.99</b>
965847	APW36		36"	<b>119.99</b>

## Snap Ring Pliers

OEM TOOLS®

### 6-1/2" Heavy Duty Snap Ring Pliers Set

SKU 15929  
25397 **20<sup>99</sup>**

- Tapered Tips: 0.8 mm, 1.2 mm, 1.4 mm and 2.0 mm
- Spring-Loaded Handles
- Settings: Straight, 45° and 90°



## Cutting and Scraping Tools

### Folding Lock Back® Utility Knife with Blade Dispenser

SKU 1022296  
25537 **16<sup>99</sup>**

- Includes: Blade Dispenser with 50 Blades
- Extra-Wide Handle for Increased Comfort and Leverage



OEM TOOLS®

### Premium Folding Lock Back® Utility Knife with Sheath

SKU 1142419  
12818 **24<sup>99</sup>**

- 3-1/2" Stainless Steel and Hardwood Handle
- Patented Quick-Change Mechanism
- Accepts All Standard Utility Blades
- Includes: 1 Blade and Leather Sheath with Pocket Clip



SHEFFIELD®

### 4 Piece Plastic Scraper Set

SKU 900802  
25513 **10<sup>99</sup>**

- Works Like a Chisel
- Will Not Scratch Paint
- Will Not Cause Sparks
- Can Be Used for Wheel Weight Removal

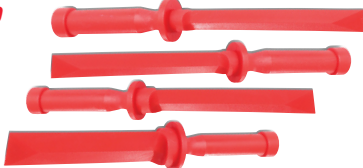

OEM TOOLS®

### 10" Utility Scissors

SKU 1142911  
25085 **13<sup>99</sup>**

- Super Hard Diamond-Like Carbon (DLC) Coating
- Stainless Steel Construction for Strength and Durability
- Bolt Lock Keeps Blades Secure
- Full Length Metal Frame Extends Through Handle for Added Strength



OEM TOOLS®

### Scraper Kit

SKU 1282744  
69004 **24<sup>99</sup>**

- Includes: 2 Packs of Razor Blades (200) and 1 Razor Blade Scraper
- Perfect for Removing Paint and Decals



OEM TOOLS®

**24<sup>99</sup>**  
REG. \$43.97  
**SAVE OVER \$18**  
When You Buy the Kit

### Moab Auto Emergency Folding Pocket Knife

SKU 1142700  
12870 **20<sup>99</sup>**

- 3-5/16" Partially Serrated Stainless Steel Blade, 4-1/2" Folded
- One-Handed Opening Mechanism
- Liner Lock
- Glass Breaker
- Belt Cutter
- Pocket Clip
- 4.5 Oz.
- Lifetime Warranty



SHEFFIELD®

Prices subject to change without notice. Prices do not include applicable taxes, vehicles, tires, rims, installation or optional equipment as shown. Please do not return purchases to the store. For information regarding warranty, repair, or any questions or concerns, call 901-300-4878.

# HAND TOOLS

## Precision Drivers

- Precision Driver Sets for Electronics and Applications in Tight Spaces
- Magnetic Tips to Secure Fasteners
- Constructed with Durable Chrome Vanadium Steel

### 7 Piece Metric Nut Driver Set

SKU 1282732 **26<sup>99</sup>**  
22562

- Includes: 3.0, 3.5, 4.0, 4.5, 5, 5.5 and 6.0 mm

### 7 Piece Metric Hex Driver Set

SKU 1282731 **24<sup>99</sup>**  
22563

- Includes: 0.7, 0.9, 1.3, 1.5, 2.0, 2.5 and 3.0 mm



## 6 Piece Precision Screwdriver Set

- Constructed with Durable Chrome Vanadium Steel

### Star Screwdriver Set

SKU 003763 **18<sup>99</sup>**  
22559

- Set Includes: T5, T6, T7, T8, T9 and T10

### Screwdriver Set

SKU 003751 **18<sup>99</sup>**  
22560

- Slotted Screwdrivers: (1.4, 2, 2.4 and 3 mm)
- Phillips Screwdrivers: (#0 and #1)

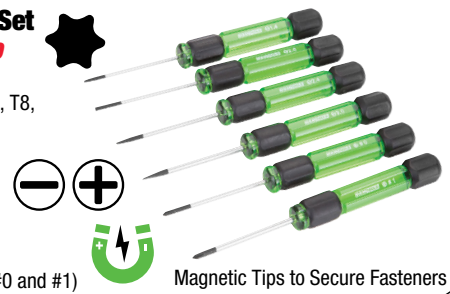

Magnetic Tips to Secure Fasteners

## Pick Sets

### 4 Piece 14" Jumbo Pick Set

SKU 094658  
25940

**43<sup>99</sup>**

- Includes: Straight, 90°, Offset and Hook Pick



### 8 Piece Combination Hook and Pick Set

SKU 1168660 **24<sup>99</sup>**  
68913

- Set Includes: 4 Pc. 8" Hook and Pick Set with Acetate Handle and 4 Pc. 6" Mini Hook and Pick Set with Cushion Grip



### 6 Piece 8" Hook and Pick Set

SKU 1207883 **20<sup>99</sup>**  
26545

- Set Includes: 1 Hook Pick, 1 Complex Pick, (1) 90° Pick, 1 Combination Pick, 1 Double Angle Pick, 1 Straight Pick



### 8 Piece 10" Cushion Hook and Pick Set

SKU 1207881 **14<sup>99</sup>**  
26526

- Set Includes: Hook Pick, 90° Pick, 45° Pick, Double Angle Pick, Complex Pick, Angle Hook Pick, Combination Pick and a Straight Pick



## Safety Wire Pliers

### Reversible Wire Twister Pliers

Includes: 10 Meter x 0.5 mm Wire

- Heavy Duty Construction with Automatic Spring Return
- Reversible Action for Left and Right Twists
- Locking Jaws for Superior Wire Twisting
- Forged High Carbon Diamond Grooved Jaws to Cut and Grip Stainless Wire



9" SKU 1362002 **69<sup>99</sup>**  
22662

6" and 9" SKU 1282746 **129<sup>99</sup>**  
22663

6" SKU 1282736 **79<sup>99</sup>**  
22661

## Hack Saws

### Professional Hack Saw

SKU 1142352 **22<sup>99</sup>**  
74007

- Includes (1) 12" 24 TPI Bi-Material Blade
- High Tension Blade Prevents Twisting to Ensure Straight, Fast Cut
- Ergonomic Comfort Grip on Front Frame and Handle Provides Two-Handed Control



### 12" Steel Adjustable Frame Pistol Grip Hacksaw

SKU OSB **30<sup>99</sup>**  
50

- Heavy Duty Adjustable Steel Frame Accepts 10" and 12" Blades
- High Impact Pistol Grip Handle
- 4 Cutting Positions and 3" Cutting Depth
- Includes (1) 10" Standard Hacksaw Blade

For OSB, Call 901-300-4878



## Bolt Cutters

### 8" Mini Bolt Cutter

SKU 479080 **34<sup>99</sup>**  
22609

- Chrome Moly Steel Construction and Induction Hardened Cutting Edges
- Designed for Heavy Duty Wire, Bolt, Nail and Rivet Cutting
- Induction Hardened Blades Rated at Over 58 HRC
- Cuts 5.0 mm Diameter Medium Hard Wire, 4.0 mm Diameter Hard Wire and 3.6 mm Piano Wire



### GreatNeck Bolt Cutters

### Bolt Cutters

- Forged S2 Steel Construction for Cutting Power
- Hardened Cutting Edge for Long Life
- Ergonomic Comfort Grip Handles
- Limited Lifetime Warranty

18" SKU OSB **34<sup>99</sup>**  
BC18



24" SKU 025213 **48<sup>99</sup>**  
BC24

36" SKU 965827 **74<sup>99</sup>**  
BC36

30" SKU 965828 **84<sup>99</sup>**  
BC30

For OSB, Call 901-300-4878

## Specialty Wrenches

### Adjustable Gland Nut Wrench

- For Hydraulic Cylinders with Gland Nuts
- Reversible Design

SKU 1207900 **16<sup>99</sup>**  
27398

- Range: 1" to 3.75"
- Pin Size: 7/32" and 1/4"
- Drive: 1/2"



SKU 1340231 **25<sup>99</sup>**  
27397

- Range: 2" to 6"
- Pin Size: 1/4" and 5/16"
- Drive: 3/4"



## Nut Drivers

### 7 Piece Professional Nut Driver Set

- Chrome Vanadium Steel for Strength and Durability
- Highest Quality Acetate Handle Stands Up to Abuse
- Color Coded for Easy Identification

Metric SKU OSB **21<sup>99</sup>**  
ND71

- Sizes: 6, 7, 8, 9, 10, 11 and 12 mm

SAE SKU OSB **17<sup>99</sup>**  
ND72

- Sizes: 3/16", 1/4", 5/16", 11/32", 3/8", 7/16" and 1/2"



### GreatNeck

For OSB, Call 901-300-4878

# THREAD REPAIR

TO ORDER, contact your Commercial Sales Manager or go to [AutoZonePro.com](http://AutoZonePro.com)

THREAD REPAIR

## Spiral Bolt Extractor Sets

Bites into Rusted, Rounded and Painted Over Nuts and Bolts

OEM TOOLS®

- Made of High-Quality Chrome Molybdenum Steel for Durability
- Grips and Removes a Wide Range of Stubborn Fasteners
- 3/8" Drive



Specialized Spiral Design for a Secure Universal Grip on Nuts and Bolts

### 5 Piece Spiral Type Deep Extractor Set on Aluminum Rail

SKU OSB 22993 **44<sup>99</sup>**

- Sizes: 3/8" (10 mm), 7/16" (11 mm), 1/2" (13 mm), 9/16" (14 mm) and 5/8" (16 mm)



For OSB, Call 901-300-4878

### 5 Piece Spiral Type Extractor Set on Aluminum Rail

SKU 081304 22985 **59<sup>99</sup>**

- Sizes: 5/16" (8 mm), 10 mm, 13 mm, 11/16" and 3/4" (19 mm)



### 10 Piece Spiral Type Bolt Extractor Set on Aluminum Rail

SKU 081788 22988 **31<sup>99</sup>**

- Sizes: 5/16" (8 mm), 3/8", 10 mm, 7/16" (11 mm), 13 mm, 11/16", 1/2" (13 mm), 9/16" (14 mm), 3/4" (19 mm) and 5/8" (16 mm)

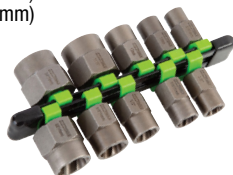

## Nut Busting Bolt Extractors

### 9 Piece (SAE) Nut Busting Bolt Extractor Socket Set

OEM TOOLS®

SKU 751720 22968 **42<sup>99</sup>**

- High Visibility Markings for Fast, Easy Socket Selection
- Chrome-Molybdenum Steel Construction for Maximum Durability
- 3/8" Drive
- Includes: 1/4", 5/16", 3/8", 7/16", 1/2", 9/16", 5/8", 11/16" and 3/4"



Specialized Design for a Secure Universal Grip

## Axle Spindle Thread Repair

OEM TOOLS®

### Axle Spindle Threading Set

SKU 1103645 37233 **65<sup>99</sup>**

- Used to Clean or Repair Axle Threads
- Set Comes with a Special Twist Shape That Provides Easier and Quicker Work
- Sizes Included: M20 x 1.25, M20 x 1.50, M22 x 1.00, M22 x 1.50, M24 x 1.50, M24 x 2.00, 13/16" x 20 UNEF, 3/4" x 20 UNEF and 27 mm Extension Bar



## Tap Sockets

OEM TOOLS®

### 8 Piece Tap Socket Set

SKU 1544666 24750 **29<sup>99</sup>**

- Designed to Fit All Standard Taps Up to 1/2"
- Compatible with 1/8" NPT Taps and Metric Taps Up to 12 mm
- Perfect for Use in Tight Spaces Where a T-Handle Cannot Fit



## Drain Plug Repair

### Oil Pan Rethreading Kit

SKU 751709 LIS58850 **164<sup>99</sup>**

- Oil Pan Plug Rethreading Kit Works on Steel or Aluminum Pans 1/2", 12 mm and 14 mm Threads



Lisle

## Screw Extractor Bit Sets

### 6 Piece Spiral Flute Screw Extractor Set

SKU 099277 24374 **11<sup>99</sup>**

- Extractors: Ex-1, Ex-2, Ex-3, Ex-4, Ex-5 and Ex-6
- Comes in a Vinyl Pouch



### 10 Piece Spiral Extractor and Drill Bit Combo Pack

OEM TOOLS®

SKU 099229 24373 **31<sup>99</sup>**

- Extractors: Ex-1, Ex-2, Ex-3, Ex-4 and Ex-5
- Left Hand 135° Split Point Cobalt
- Drill Bit Sizes: 5/64", 7/64", 5/32", 1/4" and 19/64"
- Pilot Point Starts on Contact and Eliminates Bit Walking
- Comes in a Vinyl Pouch

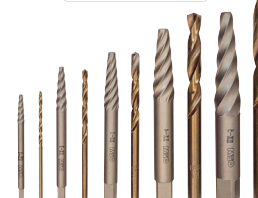

### 10 Piece Multi-Spline Screw Extractor Set

SKU 099281 24375 **45<sup>99</sup>**

- Sizes 1/8" to 13/32" (1/32" Increments)
- Can Be Used with Hand Sockets and Wrenches
- Aggressive Left Hand Spiral Design Provides Extra Gripping Power
- Designed to Prevent Extractor from Entering too Deeply and Expanding Screw
- Comes in a Foam-Lined Metal Case



### 35 Piece Master Screw Extractor/Drill Bit Set

SKU 099258 24377 **129<sup>99</sup>**

- Spiral and Multi-Spline Extractors for Removing the Toughest Bolts and Screws from 3/32" to 15/16"
- 135° Split Point Left Hand Cobalt Drill Bits
- Comes in a Plastic Blow Mold Case

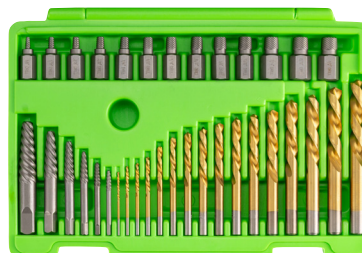

### 4 Piece Damaged Screw Extractor Set

SKU 081310 25158 **9<sup>99</sup>**

- Used to Quickly Remove Stripped, Broken and Painted Over Screws
- Will Work with Phillips, Flathead, Hex and Other Common Screws



Prices subject to change without notice. Prices do not include applicable taxes, vehicles, tires, rims, installation or optional equipment as shown. Please do not return purchases to the store. For information regarding warranty, repair, or any questions or concerns, call 901-300-4878.

AZG0226

141

# SHOP SUPPLIES

## Service Center Consumables

### Start-Up Kit (Dispenser and Product)

SKU 262544  
SNGMFKP994376

**679<sup>99</sup>**

- Kit Includes:
  - 250 Seat Covers
  - 250 Paper Floor Mats
  - 500 Plastic Floor Mats
  - 500 Parts Bags
  - 100 Tire Bags
  - 1 Metal Floor Rack
  - 1 Sign



### Plastic Write On Key Tag (1,000 Count)

- Self Locking Plastic Key Tags Help Secure Keys

**29<sup>99</sup>**

#### White

SKU 262547  
SNGMFBP993323

#### Yellow

SKU 1125859  
SNGFBP993324

#### Blue

SKU 1125872  
SNGFBP993398

#### Red

SKU 1125868  
SNGFBP993399

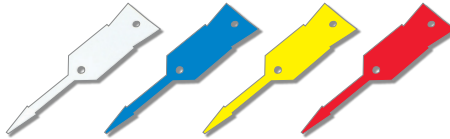

### Paper Floor Mat (500/Box)

SKU 1544671  
DOWPFM-500

**52<sup>99</sup>**

- Durable Paper
- Measures 16" x 22"



### Disposable Seat Cover

- 2-Layer Construction Keeps Cover in Place
- Refill for Start-Up Kit

#### Premium (250/Roll)

SKU 262537  
SNGMFGP994314

**119<sup>99</sup>**

- .7 Mil Thick with Dimensions of 32" x 56"

#### Value (500/Roll)

SKU 186487  
SNGMFGP994315

**139<sup>99</sup>**

- .5 Mil Thick with Dimensions of 32" x 52"



Available in .7 and .5 Mil Thickness



### Steering Wheel Cover (500/Box)

SKU 186485  
SNGMFBP994333

**74<sup>99</sup>**

- Double-Band Design Ensures a Snug Fit and Easy Installation



Vehicle Not Included



### Plastic Floor Mats (500/Box)

SKU 186488  
SNGMFGP994302

**74<sup>99</sup>**

- Roll Size: 16.5" x 21"
- Comes in Durable Self-Dispensing Box



### Parts Bag 11" x 17" (500/Case)

SKU 262541  
SNGMFGP994330

**49<sup>99</sup>**

- High Strength Protection
- Impervious to Most Shop Chemicals



Price Does Not Include Parts Shown



### Clear Work Ticket Holder (25/Box)

SKU 698887  
SNGFBP993302

**74<sup>99</sup>**

- 10.5" x 14.5" Clear Front and Back
- Durable Brass Grommet Increases Strength
- Accommodates Most Pre-Printed and Computer Generated Forms



### Adhesive Floor Mats (175/Roll)

SKU 262546  
SNGMFBP993349

**129<sup>99</sup>**

- Self Adhesive, 3 mil Protective Film Keeps Carpet Protected

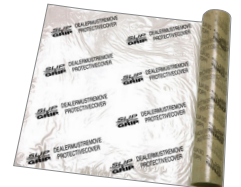

## Oil Change Printer and Labels

### Thermal Oil Change Sticker Printer Kit

SKU OSB  
SNGFKGX00106

**699<sup>99</sup>**

- Kit Includes: Printer, Keyboard, Power Cord/Adapter, 1 Ink Ribbon and 2 Rolls of 500 Generic Static Cling Labels



### Static Cling Refill Kit

SKU 291380  
SNGMFKG016501

**139<sup>99</sup>**

- 2 Rolls of Labels
- 1 Replacement Ribbon
- Fits Thermal Oil and Static Cling Printers

For OSB, Call 901-300-4878

### Service Reminder Labels

**39<sup>99</sup>**

- Replacement Roll of 500 Labels



### Red Oil Can

SKU 1405960  
SNGFB-P993345



### Blue Wrench

SKU 1407511  
SNGFB-P993394



## Hand Cleaner



### Starter Kit with Dispenser

SKU 972773  
24292

**64<sup>99</sup>**

- Kit Includes: Wall-Mount Dispenser and 4,000 mL of Cherry Fragrance Cleaner
- All Natural, Concentrated, Solvent Free Cleansing Formula
- Unique Skin Conditioning System Leaves Hands Feeling Smoother, While Fibril Scrubbers Deep Clean Even the Toughest Dirt
- 100% Biodegradable



### 4000 mL Refill Bottle

SKU 972772  
24291

**49<sup>99</sup>**

## Tumbler



### 20 Oz. Stainless Steel Double Wall Tumbler

**14<sup>99</sup>**

- Keeps Drinks Cold for 24 Hours and Hot for 6 Hours
- Lid Made from Durable BPA-Free Plastic



### Green

SKU 1392320  
26046

### Black

SKU OSB  
26047

For OSB, Call 901-300-4878



**NEW**

## Creepers

### Workshop Seat and Step Stool

SKU 1189077 **94<sup>99</sup>**  
24904

- Combination Step Stool and Creeper Seat That Allows Additional Maneuverability
- Thick Padding Covered with Durable Vinyl Provides Comfort While Working
- Includes a Tool Tray for Organization and Convenience
- 4 Swivel Casters Made for All Terrain
- Weight Capacity: 300 Lb.
- 18"(L) x 16"(W) x 7"(H)



OEM TOOLS®

### Sidekick Creeper Seat

SKU 1168662 **139<sup>99</sup>**  
24987

- Large Open Tray to Carry a Wide Range of Items with Additional Holster Caddies on the Side for Rapid Access to Most Used Items
- Slide Out Under Seat Drawer Can Be Used to Store and Organize Tools
- Weight Capacity: 330 Lb.



OEM TOOLS®

### Heavy Duty Rolling Workbench and Creeper Seat

SKU 1142423 **69<sup>99</sup>**  
24986

- Molded Seat and Frame Provide Durable Support
- Removable Clip-In Trays for Storage and Easy Transport of Parts and Tools
- Trays Feature Screwdriver Storage Holes for Easy Organization
- Weight Capacity: 300 Lb.



OEM TOOLS®

### Cushioned Creeper Seat with Tool Tray

SKU 757019 **54<sup>99</sup>**  
24948

- Tool Tray Dimensions: 11-1/2" x 12-1/2"
- Cushioned Seat
- 4 Swivel, Oil-Resistant Wheels
- Weight Capacity: 330 Lb.



OEM TOOLS®

### Mechanics Creepers with Headrest

- Made with HDPE Plastic and Molded for Comfort to Ensure a Quick and Accurate Job
- Easy to Handle, Lift and Store
- 6 Swivel Casters Able to Maneuver All Terrain
- Casters are 3" in Diameter for Additional Durability and Product Longevity
- Weight Capacity: 350 Lb.

36"

SKU 1189084 **46<sup>99</sup>**  
24977

- Light Weight 9 Lb.
- 36"(L) x 18"(W)



OEM TOOLS®

40"

SKU 1189063 **66<sup>99</sup>**  
24909

- Light Weight 13.2 Lb.
- 40"(L) x 19"(W)

66<sup>99</sup>

### Racing Body Board EVA Foam Creeper

SKU 125754 **39<sup>99</sup>**  
24972

- Dimensions: 41" x 18" x 1"
- EVA Construction is Water, Chemical and Impact Resistant
- Includes: Handle and (2) Tool Compartment Cut-Outs
- Great for Both Garage and Outdoors
- Lightweight Construction is Portable and Easy to Stow



Tools Not Included

OEM TOOLS®

### Professional 41" 6 Wheel Creeper

SKU 125749 **139<sup>99</sup>**  
24970

- 3D Streamline Design for Shoulder Clearance
- 6 Heavy Duty TPU Casters Roll Easily and are Resistant to Oil, Grease and Abrasion
- Low Ground Clearance Allows for Greater Mobility and Clearance Under Vehicles
- 4 Tool Storage Trays on Each Side and Next to the Headrest
- Weight Capacity: 300 Lb.



OEM TOOLS®

### ProGear Race Seat, Green/Black

SKU OSB **234<sup>99</sup>**  
TRX2-705

- Tray Spins for Easy Access to Tools and Parts
- Adjustable Seat Height: 13-1/2" to 17-1/2"
- Five Spoke Frame is OSHA Compliant



For OSB, Call 901-300-4878

TRAXION  
engineered products

## Topside Creepers

### Topside Creeper

SKU OSB **434<sup>99</sup>**  
TRX3-100

- Height Adjusts from 48" to 64"
- Weight Capacity: 400 Lb.



For OSB, Call 901-300-4878

TRAXION  
engineered products

## Work Stands

### Pro Step Adjustable Work Stand

SKU 222856 **334<sup>99</sup>**  
STK20350

- 500 Lb. Capacity
- Height Adjustable from 6-1/2" to 22-1/2"
- 32" x 16"



STECK

### Truck Tire Step

SKU 818571 **69<sup>99</sup>**  
24913B

- Fits Both Front and Rear 9" to 13" Wide Tires
- Powder Coat Finish
- Designed for SUVs, Motor Homes and Light Duty Trucks
- Heavily Textured Non-Slip Step for Safety
- Adjustable Rubber Bumpers Protect Your Wheels and Ensure the Step is Sturdy and Level
- Easy to Adjust
- Weight Capacity: 300 Lb.



OEM TOOLS®

# SHOP SUPPLIES

## Workshop Stools

### Adjustable Hydraulic Shop Stool

SKU OSB  
24912

**99<sup>99</sup>**

- Vinyl Padded Swivel Seat for Comfort
- Chrome Footrest
- Powder Coated Legs



Adjustable Height:  
28" to 32-1/2"



300 Lb. Weight Capacity



360° Rotating Seat

For OSB, Call 901-300-4878

### Double Ring Adjustable Stool with Backrest

SKU 1580968 **139<sup>99</sup>**  
25700

- 360° Swivel Seat
- Durable Vinyl Seat and Back Rest Cushion
- Matte Black Finish
- Adjustable Height
- Weight Capacity: 300 Lb.



Adjustable Height



Vinyl Padded, 360° Swivel Seat

### Swivel Stool with Double Ring

SKU OSB **89<sup>99</sup>**  
25701

- Thick 5" Foam Cushion
- 360° Swivel Seat
- Durable Vinyl Seat
- Matte Black Powder-Coated Frame

OEM TOOLS®



Double Ring Design Offers Added Stability and Footrest Support



Double Ring Design



Vinyl Padded, 360° Swivel Seat

For OSB, Call 901-300-4878

## Fender Covers

### Fender Cover

SKU 965832 **28<sup>99</sup>**  
24900

- Heavy Gauge Vinyl Wipes Clean
- Measures 27" x 34"



OEM TOOLS®

### Soft Fleece Fender Cover

SKU 751711 **23<sup>99</sup>**  
24899

- Soft Fleece Fender Cover to Prevent Paint Damage
- 2 Super Powerful Corner Magnets for Securing the Cover in Place
- Magnets are Removable to Wash the Cover
- Large 42" x 24" Size for Cars, Trucks and SUVs



## Magnetic Nut Cups

### Multicolor Magnetic Nut Cup Assortment (4 Pack)

SKU 1282743 **39<sup>99</sup>**  
68939

- Holds Bolts, Nuts and Parts to Speed Up Work and Eliminate Misplacing Parts
- Coated Magnet Sticks to All Ferrous Metal Work Surfaces
- Includes: 1 Green Cup, 1 Red Cup, 1 Orange Cup and 1 Blue Cup



OEM TOOLS®



Strong Magnets Attach the Cups Securely to Most Flat Metal Surfaces

Hang Hole



## Fuse Kits

### 88 Piece Master Auto Fuse Assortment

SKU 271161 **10<sup>99</sup>**  
68147

- Includes: Mini, ATO, and Maxi Fuses 3A to 100A



### 96 Piece ATO Fuse Assortment

SKU 271172 **8<sup>99</sup>**  
68149

- Includes: ATO Fuses 3A to 30A



### 24 Piece Maxi Fuse Assortment

SKU 271152 **19<sup>99</sup>**  
68146

- Includes: Maxi Fuses 20A to 100A



### 96 Piece Mini Fuse Kit

SKU 271169 **19<sup>99</sup>**  
68148

- Includes: Mini Fuses 3A to 30A



HARDWARE MACHINERY

## Hardware and Service Parts

### 34 Piece Hose Clamp Assortment

SKU 271201 **11<sup>99</sup>**  
68137

- Includes Sizes: 5/8" to 1-1/4"



### Universal O-Ring Set 419 Piece (Metric)

SKU 546659  
68167

**9<sup>99</sup>**

- Inside Diameters from 3 mm to 50 mm



### Universal O-Ring 407 Piece (SAE)

SKU 546661 **11<sup>99</sup>**  
68168

- Inside Diameters from 1/8" to 2"

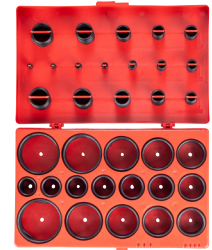

### 200 Piece Spring Assortment

SKU 271195 **15<sup>99</sup>**  
68140

- Includes: 20 Popular Sizes from 7/32" x 11/16" to 5/16" x 1-1/4"



### 110 Piece Copper Washer Assortment

SKU 271176 **22<sup>99</sup>**  
68117

- Includes: Popular Sizes M6 to M16



### 270 Piece A/C O-Ring Kit

SKU 271196 **11<sup>99</sup>**  
68141

- Contains 270 O-Rings in a Variety of SAE Sizes
- Great O-Ring Set for Most Automotive and Refrigerant Applications

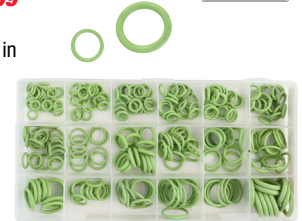

### 80 Piece Vacuum Cap Assortment

SKU 271197 **31<sup>99</sup>**  
68129

- Includes Sizes: 3/16" to 3/8"



### 555 Piece Stainless Cotter Pin Assortment

SKU 271183 **40<sup>99</sup>**  
68121

- Includes: 6 Popular Sizes from 1/16" x 1" to 5/32" x 2-1/2"



### 115 Piece Master Brake Line Fitting Assortment Kit

SKU 082943 **129<sup>99</sup>**  
DOWDY-BLF-5

- 23 Brake Line Fitting Variations
- Tube Nuts, Union, Brake Line Adapters



### 88 Piece Drain Plug and Gasket Assortment Kit

SKU 617724 **105<sup>99</sup>**  
DOWDY-DPA-6

- 18 Drain Plug Variations, 4 Gasket Variations
- Most Popular 12 mm and 14 mm Drain Plugs



### 240 Piece Master Drain Plug Gasket Assortment Kit

SKU 606762 **134<sup>99</sup>**  
DOWDY-DGK-240

- 24 Drain Plug Gasket Variations
- Aluminum, Copper, Crush, Fold-Over, Nylon, Rubber/Metal



### 120 Piece Oil Drain Plug Gasket Assortment

SKU 1400041 **34<sup>99</sup>**  
SURDPG120

- Covers Most Domestic and Import Cars and Light Trucks
- 120 Total
- Includes 24 Variations, 5 Each: Copper, Metal Crush, Nylon, Fiber and Rubber/Metal



### 76 Piece Oil Drain Plug Assortment

SKU 662839 **89<sup>99</sup>**  
SURDP454

- Includes: 76 Pieces with Corresponding Gaskets, 17 Direct Fit SKUs
- Includes: Labeled Case for Quick Identification and Organization
- Covers Most Domestic and Import Cars and Light Duty Trucks



### 60 Piece Wheel Lug Nut Assortment A

- 12 Lug Nut Variations

SKU 082947 **94<sup>99</sup>**  
DOWDY-WN-12

- Standard, Dome, Acorn Thread



SKU 082948 **149<sup>99</sup>**  
DOWDY-WN-12B

- Dome Acorn, Bulge, Flat-Capped, External Thread



# SAFETY & GLOVES

## First Aid Kits

Safeguard Employees and Jobsites Through Injury Preparation with Multi-Functional First Aid Kits

### First Aid Kits

- Wall Mountable Organized Durable Plastic Case
- Contains Essentials for Light Injuries and Wounds
- Meets ANSI/ISEA Z308.1-2021, Class A, Type I, II, III, or IV First Aid Kit

#### 25-Person First Aid Kit

SKU 1442584  
SAS6025-025 **89<sup>99</sup>**

#### 100-Person First Aid Kit

SKU 765585  
SAS6099-100 **164<sup>99</sup>**



SAS6025-025



SAS6099-100



## Safety Supplies

### Hi Vis Knit Beanie - Orange

SKU 687972  
SAS692-1711 **34<sup>99</sup>**

- One Size Fits All
- Comfortable and Warm
- 100% Knit Polyester
- ANSI/ISEA 107 Compliant
- Reflective Knit Stripe



### Hot Sleeve

SKU 291321  
LIS18700 **24<sup>99</sup>**

- Protects Arms from Burns While Working Around the Engine
- Made of Durable, Heat-Resistant Kevlar
- Double Wall Construction for Added Heat Protection



### Face Shield Clear

SKU 972271  
SAS5140 **29<sup>99</sup>**

- Impact-Resistant Polycarbonate Shield
- Curved Lens Design
- Ratcheting Headpiece
- Meets ANSI Z87.1-2015



### Foam Ear Plugs

SKU 526953  
SAS6100 **54<sup>99</sup>**

- Noise Reduction Rating: 31
- 200 Individually Packaged Pairs
- Pre-Shaped Foam Earplugs



## Safety Glasses

### LED Safety Glasses

SKU 555987  
26039 **19<sup>99</sup>**

- High-Impact Resistant Lens Protects Eyes
- Flexible, Lightweight and Padded Frames
- Meets ANSI Z87.1
- Includes: (8) LR41 Batteries



### NSX Turbo Safety Glasses

- High-Impact Polycarbonate Lens
- Safety Eyewear That Also Provides 99.9% UV Protection



**Smoke**  
SKU 462983  
SAS5331PK **19<sup>99</sup>**

- Box of 12



**Clear**  
SKU 301767  
SAS5330PK **19<sup>99</sup>**

- Box of 12



**Amber**  
SKU 462984  
SAS5332PK **19<sup>99</sup>**

- Box of 12

- Scratch-Resistant Coating
- Single Lens Design
- Lightweight Wrap-Around Lens
- ANSI/ISEA Z87.1-2015 Compliant



## Multifocal Safety Reading Glasses

- Eye Protection and Multifocal Reading Glasses
- High Impact, Anti-Scratch Lenses Protect Your Eyes
- Fully Adjustable Temples for Comfort and Fit
- ANSI/ISEA Z87.1-2015 Compliant

**26<sup>99</sup>**  
each



**+1.5**  
SKU 752076  
26023

**+2.0**  
SKU 752077  
26024

**+2.5**  
SKU 752078  
26025

**+3.0**  
SKU 752086  
26026

## Eyewash Stations

### Emergency 9 Gallon Eyewash Station Wall Mount Gravity Fed

SKU 912344  
SAS5134-00 **299<sup>99</sup>**

- Compliance - ANSI Z358.1-2014
- Portable Unit Measures 20.15" x 16.5" x 9.5"
- Includes: Mounting Bracket, Inspection Tag, Tamper Resistant Tie and Preservative

### Eyewash Concentrate Solution

SKU 1142715  
SAS5136-01 **24<sup>99</sup>**

- For Use with 9 Gallon Eyewash Station #SAS5134-00



### Bottle Eyewash Station

SKU 094904  
SAS5132 **99<sup>99</sup>**

- Includes: (2) 16 Oz. Eye Irrigate Solution Bottles
- Does Not Meet ANSI Z358.1

### 16 Oz. Eyewash Irrigate Refill

SKU 977588  
SAS5130 **29<sup>99</sup>**

- For Use with Eyewash Station SAS5132



## Detection Light

### UV Leak Detection Light and Glasses

SKU 213144  
24516 **34<sup>99</sup>**

- Compact UV Leak Detection Pen Light
- Yellow Lens Protective Glasses Enhance Visibility of Leaks
- Can Be Used with All Types of UV Leak Detection Dyes
- Includes: 2 AAA Batteries



# SAFETY & GLOVES

TO ORDER, contact your Commercial Sales Manager or go to [AutoZonePro.com](http://AutoZonePro.com)

SAFETY & GLOVES

## Raven Patriot Gloves



- 7 mil Powder-Free Exam Grade Nitrile
- Textured Fingertips
- Latex-Free



**Find In Store, Right Now**  
**31<sup>49</sup> per box**  
**STORE STOCKED**

**Large** SKU 1445914 | 66483  
**XL** SKU 1445911 | 66484



Compression Fit Technology



Environmentally Responsible



Supply Chain Resilient

### Buy More, Save More

**5 Boxes of 100 Each** **124<sup>99</sup>** ~~25.00 per box~~

<b>Medium</b>	SKU	1525554		SAS66482-5PK
<b>Large</b>	SKU	1525556		SAS66483-5PK
<b>XL</b>	SKU	1525565		SAS66484-5PK
<b>2XL</b>	SKU	1525560		SAS66485-5PK

**10 Boxes of 100 Each** **239<sup>99</sup>** ~~24.00 per box~~

<b>Medium</b>	SKU	1522380		SAS66482CS
<b>Large</b>	SKU	1525553		SAS66483CS
<b>XL</b>	SKU	1525561		SAS66484CS
<b>2XL</b>	SKU	1525562		SAS66485CS

## Raven Gloves



- 7 mil Powder-Free Exam Grade Nitrile
- Ambidextrous Textured Grip
- Latex-Free



**Find In Store, Right Now**  
**22<sup>99</sup> per box**  
**STORE STOCKED**

**Medium** SKU 435079 | 66517  
**Large** SKU 244622 | 66518  
**XL** SKU 244617 | 66519  
**XXL** SKU 435078 | 66520



### Buy More, Save More

**2 Boxes of 100 Each** **39<sup>99</sup>** ~~20.00 per box~~

<b>Medium</b>	SKU	547964		SAS66517-2PK
<b>Large</b>	SKU	547965		SAS66518-2PK
<b>XL</b>	SKU	547966		SAS66519-2PK
<b>2XL</b>	SKU	547963		SAS66520-2PK

**5 Boxes of 100 Each** **89<sup>99</sup>** ~~18.00 per box~~

<b>Medium</b>	SKU	1189346		SAS66517-5PK
<b>Large</b>	SKU	1189328		SAS66518-5PK
<b>XL</b>	SKU	1189339		SAS66519-5PK
<b>2XL</b>	SKU	1442587		SAS66520-5PK

**10 Boxes of 100 Each** **169<sup>99</sup>** ~~16.99 per box~~

<b>Medium</b>	SKU	1190191		SAS66517CS
<b>Large</b>	SKU	265052		SAS66518CS
<b>XL</b>	SKU	265053		SAS66519CS
<b>2XL</b>	SKU	1330682		SAS66520CS

## Astro-Grip Gloves



- 7 mil Powder-Free Exam Grade Nitrile
- Embossed Cube Grip
- Latex-Free



**Find In Store, Right Now**  
**31<sup>49</sup> per box**  
**STORE STOCKED**

**Medium** SKU 823166 | 66472  
**Large** SKU 823167 | 66473  
**XL** SKU 823168 | 66474  
**XXL** SKU 428345 | 66475



### Buy More, Save More

**2 Boxes of 100 Each** **47<sup>99</sup>** ~~23.99 per box~~

<b>Medium</b>	SKU	1330679		SAS66472-2PK
<b>Large</b>	SKU	1330676		SAS66473-2PK
<b>XL</b>	SKU	1331500		SAS66474-2PK
<b>2XL</b>	SKU	OSB		SAS66475-2PK

**5 Boxes of 100 Each** **119<sup>99</sup>** ~~24.00 per box~~

<b>Medium</b>	SKU	1330686		SAS66472-5PK
<b>Large</b>	SKU	1331480		SAS66473-5PK
<b>XL</b>	SKU	1331488		SAS66474-5PK
<b>2XL</b>	SKU	OSB		SAS66475-5PK

**10 Boxes of 100 Each** **209<sup>99</sup>** ~~20.99 per box~~

<b>Medium</b>	SKU	1330697		SAS66472CS
<b>Large</b>	SKU	1331497		SAS66473CS
<b>XL</b>	SKU	1331489		SAS66474CS
<b>2XL</b>	SKU	OSB		SAS66475CS

For OSB, Call 901-300-4878

Prices subject to change without notice. Prices do not include applicable taxes, vehicles, tires, rims, installation or optional equipment as shown. Please do not return purchases to the store. For information regarding warranty, repair, or any questions or concerns, call 901-300-4878.



**FREE SHIPPING**  
WITH MOST ORDERS  
SEE PAGE 2 FOR DETAILS

**2026**  
**APR-JUN**

Hablamos Español **Call 901-300-4878**

## GREAT FINANCING PROGRAMS\*

**UNISOURCE** 800-404-6792

**NEWLANE** 267-768-3228

**PEAC** 856-505-4450

### 1 LEASING COMPANIES

- Leases are handled by three companies
- Customer must:
  - Select equipment
  - Complete credit application
  - Receive approval from leasing company
- Once the transaction is approved and documents are signed by customer:
  - Customer invoice is funded by leasing company
  - Equipment order is placed

**UniSource Capital**  
Never give up...Never Surrender!<sup>®</sup>

**NL** NEWLANE  
FINANCE  
BUSINESS LENDING DONE RIGHT

**PEAC**  
SOLUTIONS

### 2 30-60-90

- AutoZone<sup>®</sup> credit account in existence for 6 months
- Satisfactory payment history with AutoZone<sup>®</sup>
- Updated account application with agreement section completed and signed
- No NSF checks within 6 months
- No credit holds within 6 months
- Established credit worthiness
- Minimum down payment = 35%
- Minimum 52 wks. sales = \$15 K
- Minimum equipment cost = \$1 K (sales tax included)

### 3 EXTENDED TERMS

- AutoZone<sup>®</sup> credit account in existence for 1 year
- Satisfactory payment history with AutoZone<sup>®</sup>
- Updated account application with agreement section completed and signed
- No NSF checks within 6 months
- Established credit worthiness
- Minimum down payment = 35%
- Minimum 52 wks. sales = \$25 K
- Minimum equipment cost by term:
  - 6 months \$3 K
  - 9 months \$6 K
  - 12 months \$8 K or greater (financial statement may be required)

\* Financing is provided by third parties who are not affiliates of AutoZone. All of the advertised loan programs, rates, terms and conditions are subject to change at any time without notice. An extra charge may be imposed at the end of the lease depending on the residual value of the leased goods. Free overnight shipping available to continental U.S. for qualifying VDP orders of 70 lb. or less. Free overnight shipping excludes: liftgate fees, residential delivery, non-network carriers, and certain freight intensive items that are shipped FOB.

©2026 GreatNeckTools, Inc. Certain content provided by and is the property of AutoZone Parts, Inc. All rights reserved. AutoZone, AutoZone & Design, Loan A Tool, Duralast, Duralast Gold, Duralast Proven Tough and Duralast ProPower are registered marks of AutoZone IP LLC or one of its affiliates. All other marks are the property of their respective holders. iPhone<sup>®</sup> and iPad<sup>®</sup> are registered trademarks of Apple Inc., Android<sup>®</sup> is a trademark of Google Inc., STP<sup>®</sup> is a registered trademark of the Energizer Auto, Inc., and Bluetooth<sup>®</sup> is a trademark of Bluetooth<sup>®</sup> SIG, Inc. Items requiring freight shipping cannot be delivered outside of the continental United States. For shipping cost to Alaska or Hawaii, please contact Commercial Sales Manager. Ad prices cannot be combined with any other offer. Offers may vary by market. Offers valid while quantities last. Items may not be available at all locations at all times. We reserve the right to limit quantities and to correct pricing errors. Some new items might not be available at the time of print deadline. Prices valid only during sales catalog effective dates. All photographic, clerical, typographical and printing errors are subject to correction. Images shown may not be actual product but represent products or sets which include product. We reserve the right to substitute a like item or an item of greater value on any promotional offer in this publication. Store stock items may be purchased at any local AutoZone store or through your AutoZone Commercial Sales Manager. Bonus items are fulfilled while supplies last and may ship separately. Bonus items may be replaced with like items of the same or greater value.