

AutoZone[®]

Tool & Equipment QUARTERLY

Call 901-300-4878

FREE SHIPPING
WITH MOST ORDERS
SEE PAGE 2 FOR DETAILS

2026
JUL-SEPT

**ENGINEERED FOR MORE AIRFLOW
AND QUIETER OPERATION**
KEEP TECHS COMFORTABLE AND PRODUCTIVE ALL DAY

OEM TOOLS[®]



20" Oscillating Pedestal Fan

SKU 1702100
34887

129⁹⁹

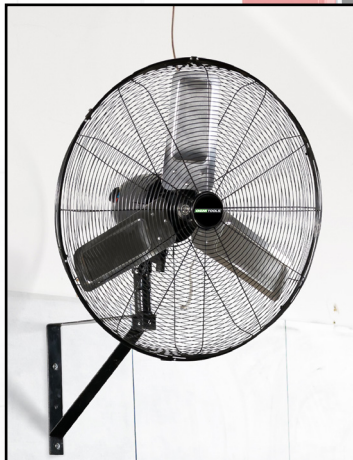

24" Oscillating Wall Mount Fan

SKU OSB
34883 **209⁹⁹**



42" Direct Drive Barrel Fan

SKU 1702110
34890 **539⁹⁹**



20" High Velocity Floor Fan

SKU 1702106
34889 **79⁹⁹**

See Page 10 for More Fans



Low Profile Jack with Stands

SKU OSB | 68969



238⁹⁹
REG. \$279.98

SAVE OVER \$40

When You Buy the Set

See Pages 69-73 for More Jacks

VT47 TPMS Tool with 4 TPMS Sensors

SKU OSB
OEMVT474K

NEW

549⁹⁹

x4
SENSORS
VALUE
\$83.96



See Pages 103-104 for More TPMS Tools



DEDICATED TO HELPING YOUR BUSINESS RUN BETTER



The AutoZone® Tool and Equipment Team is here to ensure our customers are always satisfied. As our customer, you can expect fast, personalized and professional service. Our customer service associates have over 200 years of combined experience in the tool and equipment industry.

Call AutoZone® Tool & Equipment at 901-300-4878 for Questions Concerning:

- Equipment Selection
- Product Delivery
- Service After the Sale
- Product Availability
- Technical Support
- Ordering Capital Equipment

Call Your AutoZone® Commercial Sales Manager or Go to AutoZonePro.com

- To Place Orders for Parts, Tools and Equipment
- For Questions Related to Parts and Vehicle Accessories
- For Commercial Credit, Lease or Financing Information

Section 179 and 100% first-year depreciation may allow immediate write-off of qualified equipment placed in service in 2026. Check with your CPA.

Scan This QR Code to Link to the Digital AutoZone Tool & Equipment Catalog on AutoZonePro.com



FREE OVERNIGHT SHIPPING



Free overnight shipping available to continental U.S. for qualifying orders of 70 lb. or less. Free overnight shipping excludes: liftgate fees, residential delivery, non-network carriers, and certain freight intensive items that are shipped FOB.

IMPORTANT INFORMATION ABOUT RECEIVING YOUR FREIGHT ORDER

The freight company will call 24 hours prior to delivery. It is important to take or return their calls to schedule delivery. Most items are shipped freight prepaid. Limited access, residential, carrier surcharges, redelivery and storage fees are not included.

OFFLOADING? Do you need:



- Items shipped via flatbed and most lifts will require a forklift.
- Palletized items including most capital equipment and tool storage require a liftgate or forklift.
- Drivers will not allow you to break down pallets and offload by hand.
- Inside delivery is not available. Product will be dropped as close as safely possible. Make sure your location is accessible to the truck and driver.
- DO NOT SIGN until you have inspected the freight and confirmed carton/pallet count.

- Refuse shipment and/or notate any discrepancies or possible hidden damage on the bill of lading.
- DO NOT ACCEPT OR SIGN FOR DAMAGED ITEMS. Accepting and signing for a damaged or short shipment without notation releases the carrier and distributor from any claim or responsibility.
- Contact us at 901-300-4878 immediately with any questions or problems with delivery.
- For hidden minor or cosmetic damage, we may at our discretion, choose to send replacement parts.

ASK BEFORE YOU RETURN

Many of the Tool and Equipment products are covered by the manufacturer's warranty and will be serviced and repaired in the field.

Note: Most manufacturers require you to register your products with them before receiving support or service.

IF YOU HAVE QUESTIONS ABOUT WARRANTY OR RETURNS CALL 901-300-4878.

AUTOZONE® STORE MANAGERS AND COMMERCIAL SALES MANAGERS

Call Your Tool & Equipment Team at 901-300-4878 for Questions Regarding:

- Product Ordering and Availability
- Assisting Customers with Price Quotes
- Service After the Sale
- Help with Outside Buy/EPO Orders

Prices subject to change without notice. Prices do not include applicable taxes, vehicles, tires, rims, installation or optional equipment as shown. Please do not return purchases to the store. For information regarding warranty, repair, or any questions or concerns, call 901-300-4878.

To place orders or for pricing contact your AutoZone® Commercial Sales Manager.
For product information, availability and product support, **call 901-300-4878.**

TOOLS AND EQUIPMENT IN THIS ISSUE:

Advanced Driver Systems (ADAS) . . .29	Engine Stands & Cranes . . .72-73, 117	Lighting & Flashlights13, 32-34	Smoke Leak Detectors27, 115
Air Compressors74-75	Evaporative Coolers10-11, 98	Motorcycle Lift95	Specialty Tools52-58, 115, 117
Air Conditioning14-24, 115	Exhaust Tubing Bender127	Oil Change40-43, 117	Spark Plug Thread Repair62
Air Hoses & Reels81	Fans10-11	Paint & Body90, 129	Surface Prep78, 80
Air Tools & Accessories76-81	Fluid Handling44-48, 114	Parts Washers98, 125-126	Technician Sets47, 84
Alignment86-90, 97	Generators127	Power Tools & Accessories82-85	Thread Repair141
Automotive Lifts90-97, 117	Gloves130, 147	Pressure Washers127	Tire Service90, 94, 98-109, 116
Battery Service35-38	Grease Guns39	Pullers20, 35, 53, 55, 58-61, 65-68, 114-115, 124, 129	Tool Organization122-123
Brake Lathes110	Hand Tools5-9, 132-140	Ratchets5, 134-135	Tool Storage118-121
Brake Service110-114	Hardware Kits19, 23-24, 52, 144-145	Regulators, Filters & Drains81	Torque Wrenches56, 106
Chassis & Suspension64-68	Heating & Cooling10-13	Rivet Tools57	TPMS Tools103-104
Cooling System49-51, 115	Heavy Duty115-117	Safety Supplies146-147	Vacuum Pumps17
Creepers, Seats & Stools143-144	Inflators104	Scan Tools26, 28, 30-31, 115	Welding & Cutting130-131
Diagnostics25-31, 62, 115	Jacks & Hydraulics69-73, 117	Shop Equipment124-128	Wheel Weights108-109
Disconnect Tools52	Jump Starters36	Shop Presses124	Wrenches6, 9, 132
Drill Bits & Extractor Sets141	Key Machines128	Shop Supplies142-145	
Engine Service59-63			

BRANDS IN THIS ISSUE:

ABAC74-75	Cutting Edge73	Lisle40, 43, 52, 54-55, 59-60, 62-63, 66, 107, 113, 129, 141, 146	Robinair15-16
Access Tools57	DEWALT85	Livernois63	Rotary87, 92, 99, 116
Aircat76-77	Duralast5-9	Mahle14, 16, 48, 51	SAS146-147
AirSept24, 52	EcoTechnics14, 16	Marson57, 62	Shark40, 80, 82, 84, 96, 105, 111, 126, 130-131
ALLDATA25	EnergyLogic12	Mastercool11, 15-24, 27, 49, 52, 113, 115	Sheffield121, 139
American Forge & Foundry70-73, 117	FJC Inc.19	MaxJax95	Slip-N-Grip142
Arrow Pneumatics81	Flexzilla34, 81	Mi-T-M127	Solar36, 38
Associated35-38	Flo-Dynamics48	Midtronics35	SP Tools34
Astro77, 104	Forney Industries131	Mighty Seven/M777	SRI125
Atlas Equipment94	Forward Lift89, 92	Mityvac31, 44-45, 112	Steck54, 57, 72, 143
Autel26, 28-29, 38, 104	GearWrench30, 132	MotorVac29, 48, 114	Streamlight34
Balcrank47, 51	GreatLite34	Nitrous Keys128	SUNEX79
BendPak73, 89, 93-98, 117, 127	GreatNeck133, 138-140	OEMTOOLS10, 16-20, 22-24, 27-28, 32-36, 38-47, 49-73, 76-85, 88, 95, 103-104, 106-109, 111-115, 117, 120-127, 129, 131-144, 146	Sunfire12
Branick65, 107	H&S Autoshot129-131	Phoenix Systems112, 114	SUR&R29, 41-42, 145
BRM60, 114, 125	Hardware Machinery23, 144-145	Portacool11	Sure Shot114
CEMB87, 100, 102	Hofmann86, 88-89, 102	Power Probe30, 55	Sylvania13
Central Tools56, 106, 111	Homak118-121	Pro-Cut110	TEXA14, 16, 31, 115
Challenger Lifts73, 89, 91, 95-96, 117	Ingersoll Rand76-78	QSP65, 88	TMR/The Main Resource105
Champion Power Equipment127	Innova31	Quality Lifts91	TOPDON26, 35-38
Coats87, 89, 92, 99, 101, 105, 116	IPC126	QuickJack Lifts95	Traxion143
Cool Boss11, 98	John Dow46, 142	Ranger47, 71-72, 98, 100, 102, 110, 116, 126	Tuxedo90
CPS15-17, 23, 115	John Dow Dynamic52, 145	Redline27	UView21-22
CRC126	Ken-Tool127		Viking121
Crushproof Tubing Co.13	Lanair12		VIM Tools112
CTA42, 59, 62	Lang29, 113		Water Works125
	Launch16, 35, 86		Xtra Seal107
	Lincoln39-40, 45-46, 81, 125		

Prices subject to change without notice. Prices do not include applicable taxes, vehicles, tires, rims, installation or optional equipment as shown. Please do not return purchases to the store. For information regarding warranty, repair, or any questions or concerns, call 901-300-4878.

NEW ITEMS

Diagnostics

Smoke Machine UV Smoke Kit

SKU OSB
RED96-0303 **99⁹⁹**

8 Oz. UV Smoke Producing Fluid

SKU OSB
RED96-0039-UV **41⁹⁹**

See More **DIAGNOSTICS** on Pages 25-31



NEW

Air Conditioning

AC Valve Core Removal Tool R134a, R1234yf

SKU OSB
44891 **58⁹⁹**

NEW



Paint & Body

Glue Pull Repair System

SKU OSB
HSAGPR-7571 **799⁹⁹**

See More **PAINT & BODY** on Page 129



NEW

Pull-PRO Portable Dent Pulling Tower

SKU OSB
HSAUNI-1096

1,399⁹⁹

NEW

Air Suction Plate Grips to Any Shop Floor



AC519 Plus A/C Service Station, 110V

SKU OSB
LAU703030084

4,699⁹⁹

NEW

Includes Both R134a and R1234yf Connector Sets in One Package



LAUNCH

See More **AIR CONDITIONING** on Pages 14-24

Engine Service

11 mm x 1.5 D Honda Head Repair Kit

SKU OSB
CTA1420 **93⁹⁹**

See More **ENGINE SERVICE** on Pages 59-63



NEW

3.5 L and 3.7 L Camshaft Holding Tool Set

SKU OSB
44889 **39⁹⁹**

NEW



Oil Service

20-Quart Drain Pan - Green

SKU OSB
87321 **12⁹⁹**

NEW

See More **OIL CHANGE** on Pages 40-43



Alignment

X-613 Mobile Wheel Aligner

SKU OSB
LAU702020112TF

14,839⁹⁹

See More **ALIGNMENT** on Pages 86-90

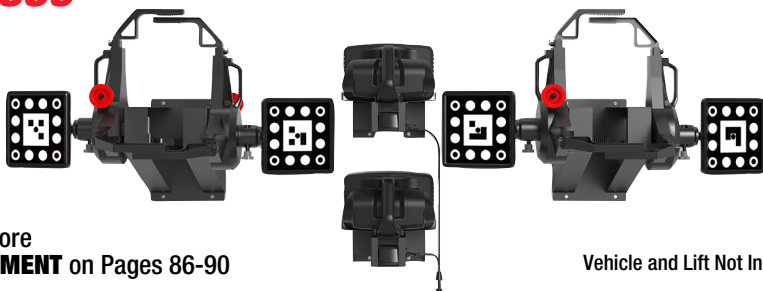

LAUNCH

Vehicle and Lift Not Included



Prices subject to change without notice. Prices do not include applicable taxes, vehicles, tires, rims, installation or optional equipment as shown. Please do not return purchases to the store. For information regarding warranty, repair, or any questions or concerns, call 901-300-4878.

Duralast® SOCKETS & RATCHETS

Duralast 1/4" Socket Sets

11⁹⁹
12PC MM
SKU 570651

9⁹⁹
10PC SAE
SKU 569668



- 6-point standard sockets
- Featuring off-corner loading design to help prevent the rounding of fasteners
- Alloy Steel sockets heat treated for superior strength

Duralast 1/4" Deep Socket Sets

14⁹⁹
12PC MM
SKU 569687

12⁹⁹
10PC SAE
SKU 569663



- 6-point deep sockets
- Featuring off-corner loading design to help prevent the rounding of fasteners
- Alloy Steel sockets heat treated for superior strength

Duralast

10PC 3/8" Socket Sets MM SKU 569683 | SAE SKU 569697

14⁹⁹
each



- 6-point standard sockets
- Featuring off-corner loading design to help prevent the rounding of fasteners
- Alloy Steel sockets heat treated for superior strength

Duralast

10PC 3/8" Deep Socket Sets MM SKU 570920 SAE SKU 570646

19⁹⁹
each



- 6-point deep sockets
- Featuring off-corner loading design to help prevent the rounding of fasteners
- Alloy Steel sockets heat treated for superior strength

Duralast

10PC 1/2" Socket Sets MM SKU 570650 | SAE SKU 569711

17⁹⁹
each



- 12-point standard sockets
- Featuring off-corner loading design to help prevent the rounding of fasteners
- Alloy Steel sockets heat treated for superior strength

Duralast

10PC 1/2" Deep Socket Sets MM SKU 569639 SAE SKU 569643

24⁹⁹
each



- 12-point deep sockets
- Featuring off-corner loading design to help prevent the rounding of fasteners
- Alloy Steel sockets heat treated for superior strength

Duralast

3/8" Drive 100 Position Stubby Ratchet SKU 565719



19⁹⁹

- 100-position flex-head full polish sealed head ratchet
- Professional, full polish chrome handle
- 100-position ratchet provides 3.6 degrees of ratcheting arc

Duralast

100 Position Flex Head Ratchets



24⁹⁹
1/4" Drive
SKU 565715

- 100-position flex-head full polish sealed head ratchet
- Alloy Steel heat treated for superior strength
- Professional, full polish chrome handle
- 100-position ratchet provides 3.6 degrees of ratcheting arc

24⁹⁹
3/8" Drive
SKU 565718

Duralast

100 Position Ratchets



17⁹⁹
1/4" Drive
SKU 565700

- 100-position polish sealed head ratchet
- Alloy Steel heat treated for superior strength
- Professional, full polish chrome handle
- 100-position ratchet provides 3.6 degrees of ratcheting arc

19⁹⁹
3/8" Drive
SKU 565717

24⁹⁹
1/2" Drive
SKU 565721

Duralast® EVA FOAM SETS



Introducing the all new Duralast EVA Foam Mechanic Tool Sets

- Premium cut EVA Foam Sets ensure convenient and organized storage
- Professional grade tools, fully guaranteed for life
- Designed to fit in existing Duralast Tool Boxes

Duralast

3PC 100-Position Ratchet Set
SKU 1571889

59⁹⁹



- 100-position sealed head ratchets provide 3.6° arc swing
- Includes 1/4", 3/8", and 1/2" drive ratchets
- Includes EVA foam tray for convenient storage of ratchets

Duralast

5PC Impact Accessory Set
SKU 1571894

24⁹⁹



- 6" and 10" length impact extension bars
- 3/8" and 1/2" drive impact adapters
- Includes EVA foam tray for convenient storage of accessories
- Impact grade alloy steel heat treated for superior strength

Duralast

19PC Impact Accessory Set
SKU 1571890

44⁹⁹



- Ball detent secures sockets to the accessories
- Includes EVA foam tray for convenient storage of accessories
- Alloy steel heat treated for superior strength
- Professional, full polish finish

Duralast

53PC 3/8" Drive Socket Set
SKU 1571888

59⁹⁹

- Includes EVA Foam tray for convenient storage of ratchet, sockets, and accessories
- 100-position sealed head ratchet
- 6-point standard and deep sockets
- Sockets feature off-corner loading design to help prevent the rounding of fasteners



Duralast

67PC 1/2" Drive Socket Set
SKU 1571892

119⁹⁹

- Includes EVA foam tray for convenient storage of ratchet, sockets, and accessories
- 100-position sealed head ratchet
- 12-point standard and deep sockets
- Sockets feature off-corner loading design to help prevent the rounding of fasteners



Duralast

80PC Master Bit Socket Set
SKU 1571891

89⁹⁹

- Hex, Torx®, Tamper-Proof Torx®, External Torx®, Phillips®, Slotted, and Triple Square style bit sockets
- Includes EVA foam tray for convenient storage of ratchets, sockets, and accessories
- 100-position sealed head ratchets
- Premium S2 steel bits for durability



Duralast

34PC Master Combination Wrench Set
SKU 1571893

119⁹⁹

- 12-point long pattern and stubby combination wrenches (SAE and MM)
- Includes EVA foam tray for convenient storage of wrenches
- Featuring off corner-loading design to help prevent the rounding of fasteners
- 15° offset box ends provides clearance for knuckles



Duralast® MECHANIC'S TOOL SETS

Duralast NEW!

42PC 1/2" Drive Mechanic's Tool Set
SKU 1545050

59⁹⁹

- 1/2" Drive mechanics tool set
- 12-point standard and deep sockets
- Sockets feature off-corner loading design to help prevent the rounding of fasteners
- Alloy Steel sockets and drive tools heat treated for superior strength



Duralast NEW!

60PC Master Bit Set
SKU 1545051

44⁹⁹

- Hex, Torx®, Tamper-ProofTorx®, External Torx®, Phillips®, Slotted, and Triple Square style bit sockets
- Professional, full polish chrome base
- Premium S2 steel bits for durability
- Chamfered lead-ins for easy placement onto drive tools and fasteners



Duralast

265PC Mechanic's Tool Set
SKU 1077624

179⁹⁹

- 1/4", 3/8", and 1/2" drive mechanic's tool set
- 6-point standard and deep sockets (1/4", 3/8" drive) and 12-point standard sockets (1/2" drive)
- Sockets feature off-corner loading design to help prevent the rounding of fasteners
- Alloy Steel sockets and drive tools heat treated for superior strength



Duralast

180PC Mechanic's Tool Set
SKU 52378

129⁹⁹

- 1/4", 3/8", and 1/2" drive mechanic's tool set
- 6-point standard and deep sockets (1/4", 3/8" drive) and 12-point standard sockets (1/2" drive)
- Sockets feature off-corner loading design to help prevent the rounding of fasteners
- Alloy Steel sockets and drive tools heat treated for superior strength



Duralast

90PC Mechanic's Tool Set
SKU 52377

79⁹⁹

- 1/4" and 3/8" drive mechanic's tool set
- 6-point standard and deep sockets
- Sockets feature off-corner loading design to help prevent the rounding of fasteners
- Alloy Steel sockets and drive tools heat treated for superior strength



Duralast

60PC Mechanic's Tool Set
SKU 15881

59⁹⁹

- 3/8" drive mechanic's tool set
- 6-point standard and deep sockets
- Sockets feature off-corner loading design to help prevent the rounding of fasteners
- Alloy Steel sockets and drive tools heat treated for superior strength



Duralast

45PC Mechanic's Tool Set
SKU 15879

39⁹⁹

- 1/4" drive mechanic's tool set
- 6-point standard and deep sockets
- Sockets feature off-corner loading design to help prevent the rounding of fasteners
- Alloy Steel sockets and drive tools heat treated for superior strength
- Premium S2 steel bits for durability



Duralast® **IMPACT TOOLS**



Duralast Impact Tools, Built to Withstand the Toughest Jobs

- Created with Chrome Molybdenum (Cr-Mo) steel for strength and durability in impact use
- Black oxide finish resists corrosion and withstands impact application
- All sockets feature patented off corner loading design, to reduce rounding of fasteners
- Innovative 3/8" Drive impact sockets feature a thin wall design for additional access

Duralast

7PC 1/2" Drive Torx® Bit Impact Socket Set

SKU 208502

24⁹⁹



- Set Includes: (7) 1/2" Drive Deep Torx® Bit Impact Sockets: T40, T45, T47, T50, T55, T60, T70

Duralast

7PC 1/2" Drive Impact Hex Bit Socket Sets

MM SKU 1077628 | SAE SKU 1077626



24⁹⁹ each

- Metric Set Includes: (7) 1/2" Drive Impact Hex Bit Sockets: 9, 10, 11, 12, 13, 14, 15 mm
- SAE Set Includes: (7) 1/2" Drive Impact Hex Bit Sockets: 3/8", 7/16", 1/2", 9/16", 5/8", 11/16", 3/4"

Duralast

2PC 1/2" Drive Impact Extension Set

SKU 914182

14⁹⁹



- Set Includes: (2) 1/2" Drive Impact Extensions: 6", 12"
- Forged Chrome Molybdenum Alloy Steel for strength and durability in impact use

Duralast

4PC Impact Flip Socket & Extension Kit

SKU 1077627

19⁹⁹



- Set Includes: (3) 1/2" Drive Flip Impact Sockets- 21 mm x 22 mm, 7/8" x 15/16", 3/4" x 13/16". (1) 1/2" Drive Impact Extension: 3"
- Forged Chrome Molybdenum Alloy Steel for strength and durability in impact use

Duralast

10PC 3/8" Drive Thin Wall Impact Socket Sets

MM SKU 1227805 | SAE SKU 1227807



24⁹⁹ each

- Metric Set Includes: (9) 3/8" Drive Thin Wall Impact Sockets: 8, 9, 10, 12, 13, 15, 16, 17, 18 mm. (1) 1/4" hex x 3/8" drive adapter.
- SAE Set Includes: (9) 3/8" Drive Thin Wall Impact Sockets: 5/16", 11/32", 3/8", 7/16", 1/2", 9/16", 5/8", 11/16", 3/4". (1) 1/4" hex x 3/8" drive adapter.

Duralast

10PC 1/2" Drive Metric Deep Impact Socket Set

SKU 914180

29⁹⁹



- Metric Set Includes: (10) 1/2" Drive Metric Deep Impact Sockets: 10, 11, 12, 13, 14, 15, 16, 17, 18, 19mm
- Forged Chrome Molybdenum Alloy Steel for strength and durability in impact use
- Chamfered lead-ins help to provide fast and easy placement of sockets and accessories onto drive

Duralast

10PC 1/2" Drive Shallow Impact Socket Sets

MM SKU 914179

SAE SKU 914183

24⁹⁹ each



- Metric Set Includes: (10) 1/2" Drive Metric Impact Sockets: 11, 12, 13, 15, 16, 17, 19, 21, 22, 24 mm
- SAE Set Includes: (10) 1/2" Drive SAE Impact Sockets: 7/16", 1/2", 9/16", 5/8", 11/16", 3/4", 13/16", 7/8", 15/16", 1"
- Forged Chrome Molybdenum Alloy Steel for strength and durability in impact use

Duralast

9PC 1/2" Drive SAE Deep Impact Socket Set

SKU 569664

29⁹⁹



- Set Includes: (9) 1/2" Drive SAE Deep Impact Sockets: 1/2", 9/16", 5/8", 11/16", 3/4", 13/16", 7/8", 15/16", 1"
- Forged Chrome Molybdenum Alloy Steel for strength and durability in impact use
- Chamfered lead-ins help to provide fast and easy placement of sockets and accessories onto drive

Duralast

5PC Impact Adapter Set

SKU 914056

14⁹⁹



- Set Includes: (1) 1/4" Drive Impact Adapter, (2) 3/8" Drive Impact Adapters, (2) 1/2" Drive Adapters
- Forged Chrome Molybdenum Alloy Steel for strength and durability in impact use
- Chamfered lead-ins help to provide fast and easy placement onto fasteners

Duralast® RATCHETING WRENCH SETS



Work Faster and Smarter with Duralast Ratcheting Wrenches

- 72T Ratcheting box ends need as little as 5 degrees of sweep to move a fastener
- The small ratcheting box end head allows for access to tight areas where a ratchet won't fit
- Manufactured from alloy steel for superior strength and longer life span
- Available in 12-pt. ratcheting, 12-pt. flex-head ratcheting, 12-pt. reversible ratcheting, 12-pt. combination ratcheting, and universal profile ratcheting

Duralast

6PC Flex-Head Ratcheting Wrench Sets

MM SKU 569808
SAE SKU 569818

49⁹⁹
each



- 12-point flex head ratcheting combination wrenches
- Ratcheting flex heads allow for accessing fasteners at an angle for improved access
- Featuring off-corner loading design to help prevent the rounding of fasteners

Duralast

6PC Universal Ratcheting Wrench Sets

MM SKU 570925
SAE SKU 570926

29⁹⁹
each



- Universal profile ratcheting box-ends allow engagement on 6 fastener types (6-point, 12-point, partially rounded, spline, square, and External TORX®)
- Alloy Steel wrenches heat treated for superior strength
- Chamfered lead-ins for easy placement onto fasteners

Duralast

6PC Reversible Ratcheting Wrench Sets

MM SKU 570923
SAE SKU 569807

49⁹⁹
each



- 12-point reversible ratcheting combination wrenches
- Featuring off-corner loading design to help prevent the rounding of fasteners
- Alloy Steel ratcheting wrenches heat treated for superior strength

Duralast

6PC Ratcheting Wrench Sets

MM SKU 569779
SAE SKU 570921



29⁹⁹
each

- 12-point ratcheting combination wrenches
- Featuring off-corner loading design to help prevent the rounding of fasteners
- Alloy Steel ratcheting wrenches heat treated for superior strength

Duralast

2PC Quadbox Ratcheting Wrench Sets

MM SKU 951644
SAE SKU 951643

24⁹⁹
each



- 12-point metric reversible ratcheting 4-in-1 wrenches
- Each wrench features 4 sizes for convenience
- Alloy Steel ratcheting wrenches heat treated for superior strength
- Reversing levers allow quick directional changes

HEATING & COOLING

Raise Productivity: Keep Your Technicians Cool And Comfortable

OEM TOOLS



Locking Swivel Casters



Hose-Ready Fill Connection



Molded Top Tray

Evaporative Coolers

3100 CFM
SKU 213184
23968 **549⁹⁹**

- 1/5 HP 3 Speed Motor
- Water Capacity: 10.3 Gallons
- Cooling Area: 950 Sq. Ft.
- Dimensions: 37" x 17" x 25"
- Weight: 39 Lb.

5300 CFM
SKU 213172
23969 **699⁹⁹**

- 1/3 HP 3 Speed Motor
- Water Capacity: 14.6 Gallons
- Cooling Area: 1,600 Sq. Ft.
- Dimensions: 45" x 17" x 28"
- Weight: 56 Lb.

Replacement Media Sets

For 23968/23976
3100 CFM
SKU 1485034
HESCP370 **109⁹⁹**

For 23969/23977
5300 CFM
SKU 1485036
HESCP610 **129⁹⁹**

OEMTOOLS FANS

Precision-Balanced Blades Reduce Noise and Move More Air

OEM TOOLS



Oscillating Pedestal Fans

20"
SKU 1702100
34887 **129⁹⁹**

- 3,320 CFM

30"
SKU 1702108
34888 **249⁹⁹**

- 7,800 CFM

Adjustable-Height
Pedestal, Oscillation and
3-Speed Airflow Control

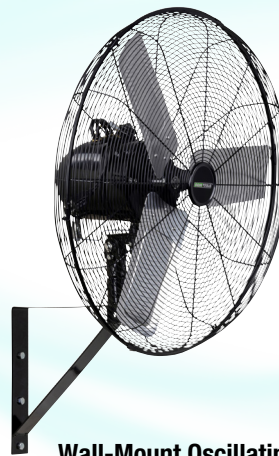

Wall-Mount Oscillating,
High-CFM Airflow and
3-Speed Control

Indoor Oscillating Wall Mount Fans

24"
SKU OSB
34883 **209⁹⁹**

- 4,216 CFM

30"
SKU 1702112
34885 **229⁹⁹**

- 6,387 CFM

For OSB, Call 901-300-4878



Outdoor Oscillating Wall Mount Fans

- IP44 Water Resistance Rating for Outdoor Use



24"
SKU 1702113
34884 **249⁹⁹**

- 5,500 CFM

30"
SKU 1702111
34886 **309⁹⁹**

- 7,500 CFM



20" High Velocity Floor Fan
SKU 1702106 **79⁹⁹**
34889

- 3,522 CFM

High-Velocity Floor Fan for Shop, Garage or Bay Cooling



42" Direct Drive Barrel Fan
SKU 1702110 **539⁹⁹**
34890

- 17,840 CFM

Direct-Drive Barrel Fan for Large Work Areas

To Confirm Price, Availability and Ordering Instructions on OSB, Call 901-300-4878

Prices subject to change without notice. Prices do not include applicable taxes, vehicles, tires, rims, installation or optional equipment as shown. Please do not return purchases to the store. For information regarding warranty, repair, or any questions or concerns, call 901-300-4878.

HEATING & COOLING

TO ORDER, contact your Commercial Sales Manager or go to AutoZonePro.com

HEATING & COOLING

PORTACOOOL

PEAK COOLING, INTELLIGENT CONTROL

- Portacool APEX™ Series
- Setting the STANDARD for Auto Shop Cooling
- HydroTek™ Evaporative Media – designed to MAXIMIZE cooling performance with less maintenance
- Control Your Comfort with COOLSYNC™ – Sync your Portacools to your smartphone for intelligent control
- Fan Speed
- Wind Direction
- Water Control
- Group Syncing
- Scheduling



PRCA05001A1

Apex 500

SKU 1392317
PRCA05001A1 **1,129⁹⁹**

- Cooling: Up to 500 Sq. Ft.
- Velocity: 40 MPH
- Air Flow Reach: 55 Ft.
- Water: 13 Gal.

Apex 700

SKU 1392315
PRCA07001A1 **1,649⁹⁹**

- Cooling: Up to 700 Sq. Ft.
- Velocity: 37 MPH
- Air Flow Reach: 60 Ft.
- Water: 22 Gal.



PRCA12001A1

Apex 1200

SKU 1392332
PRCA12001A1 **2,469⁹⁹**

- Cooling: Up to 1200 Sq. Ft.
- Velocity: 25 MPH
- Air Flow Reach: 40 Ft.
- Water: 40 Gal.

Apex 2000

SKU 1392329
PRCA20001A1 **3,379⁹⁹**

- Cooling: Up to 2000 Sq. Ft.
- Velocity: 28 MPH
- Air Flow Reach: 60 Ft.
- Water: 45 Gal.



PRCA65001A1

Apex 4000

SKU 1392335
PRCA40001A1 **3,879⁹⁹**

- Cooling: Up to 4000 Sq. Ft.
- Velocity: 25 MPH
- Air Flow Reach: 50 Ft.
- Water: 55 Gal.

Apex 6500

SKU 1392341
PRCA65001A1 **5,169⁹⁹**

- Cooling: Up to 6500 Sq. Ft.
- Velocity: 24 MPH
- Air Flow Reach: 40 Ft.
- Water: 66 Gal.



Customer Responsible for Offloading, Liftgate Service Available | We Offer the Full Line of Portacool and Cool Boss Evaporative Coolers and Accessories

Evaporative Coolers



- 80W 4000 Lumens Adjustable LED Floodlight
- Anion Negative Ion Air Purifier
- Low Level Shutoff
- Built-In Bluetooth® Audio Player and Speakers
- Wireless Remote Control

CB-12L

SKU OSB
CLBCB-12SL **1,529⁹⁹**

- Max. Airflow: 1,565 CFM
- Cooling Area: 650 Sq. Ft.
- Fan Diameter: 12"

CB-16L

SKU 1275460
CLBCB-16L **2,649⁹⁹**

- Max. Airflow: 4,950 CFM
- Cooling Area: 1,125 Sq. Ft.
- Fan Diameter: 16"

CB-36L

SKU 1275465
CLBCB-36L **4,539⁹⁹**

- Max. Airflow: 12,615 CFM
- Cooling Area: 3,125 Sq. Ft.
- Fan Diameter: 36"

CB-14L

SKU OSB
CLBCB-14SL **1,779⁹⁹**

- Max. Airflow: 2,300 CFM
- Cooling Area: 850 Sq. Ft.
- Fan Diameter: 14"

CB-28L

SKU 1275461
CLBCB-28L **3,499⁹⁹**

- Max. Airflow: 9,020 CFM
- Cooling Area: 2,125 Sq. Ft.
- Fan Diameter: 28"



CLBCB-16L

For OSB, Call 901-300-4878

Blower Fans



300 CFM Blower Fan

SKU 1392323
MSC20300-A **127⁹⁹**

- 120 Volts, 60 Hz
- For Indoor or Outdoor Use
- 3-Speed Switch (High, Medium, Low)
- 4-Position Adjustment Feet
- 8.5 Ft. Cord Length



Heater Attachment for 300 CFM Blower

SKU 396571
MSC20300-HTR **69⁹⁹**

- Converts Your 300 CFM Portable Blower into a Heater for Your Garage or Work Space
- 1320 Watts, 5000 BTU
- Fits Many Popular Brands (300 CFM Only. Not for 1,200 CFM Fans.)



Prices subject to change without notice. Prices do not include applicable taxes, vehicles, tires, rims, installation or optional equipment as shown. Please do not return purchases to the store. For information regarding warranty, repair, or any questions or concerns, call 901-300-4878.

HEATING & COOLING

EnergyLogic



On-board
air compressor



Burn No.2 to 90W
and synthetics



Small
footprint



ENL11075104

Stop paying to have your waste oil hauled off!
Save and burn it for **FREE** heat this winter.

75H Waste Oil Furnace with Built-In 10 Gal. Tank

FURNACE	BTUs	HEATS UP TO	PART NO.	PRICE
EL-75	75,000	1,750 Sq. Ft.	ENL11075104	4,299.99

Waste Oil Heater Complete Systems*

FURNACE	BTUs	HEATS UP TO	PART NO.	PRICE
EL-140	140,000	3,500 Sq. Ft.	ENL01140103	11,649.99
EL-200	200,000	5,000 Sq. Ft.	ENL01200104	12,899.99
EL-350	350,000	8,500 Sq. Ft.	ENL01350104	15,549.99

For OSB, Call 901-300-4878

* Complete systems include waste oil furnace and 250 gallon tank, swing-away burner with built-in air compressor, low-fuel cutoff, draft gauge, drain valve and Class A flue kit.



ENL01140103

FOR BEST PRICING,
Call 901-300-4878

Not for Sale in CA

Lanair

EXTREME PERFORMANCE BURNER

FREE Metering Pump Included!



	Heater Package*	BTUs	Heats up to	Chimney Pipe	Part Number	Price
Thru-roof chimney	LS-150R	150,000	3,500	6" Class A	LANLS150R	10,699.99
	LS-225R	225,000	5,250	8" Class A	LANLS225R	12,799.99
	LS-225DR	225,000	5,250	8" Class A	LANLS225DR	13,799.99
	LS-300R	300,000	7,000	8" Class A	LANLS300R	15,099.99
	LS-300D	300,000	7,000	8" Class A	LANLS300DR	17,449.99

* Packages Include 215 Gallon Tank and Chimney Kit

For OSB, Call 901-300-4878

Sunfire

NO SMELL NO FUMES



Portable Radiant Heaters

- Built-In Safety Features – Equipped with Tip-Over Protection, Flame-Out Sensors, and Automatic Shutoff Systems to Ensure Safe Operation in Commercial and Indoor Settings
- Infrared Radiant Heating: Clean, Quiet and Odorless
- Zero Carbon Monoxide When Properly Maintained
- Thermostat-Ready and ETL Certified for Indoor/Commercial Use
- Made in the USA with Strong Support



SFRSF120

Part Number	BTU's	Heats up to	Fuel	Tank	Price
SFRSF80	80,000	1,900 Sq. Ft.	Dual Fuel (Diesel/Kerosene)	6 Gal.	1,799.99
SFRSF120	120,000	2,800 Sq. Ft.	Dual Fuel (Diesel/Kerosene)	14 Gal.	2,599.99
SFRSF160	160,000	3,500 Sq. Ft.	Dual Fuel (Diesel/Kerosene)	19 Gal.	3,599.99

For OSB, Call 901-300-4878 Commercial/Shop Use Only | Use in Well-Ventilated Areas | Not for Residential Living Areas

To Confirm Price, Availability and Ordering Instructions on OSB, Call 901-300-4878

Prices subject to change without notice. Prices do not include applicable taxes, vehicles, tires, rims, installation or optional equipment as shown. Please do not return purchases to the store. For information regarding warranty, repair, or any questions or concerns, call 901-300-4878.

HEATING & COOLING

TO ORDER, contact your Commercial Sales Manager or go to AutoZonePro.com

HEATING & COOLING

Exhaust Hoses

Flarelock Hoses

- Made Exclusively for Cars and Small Trucks
- End is Flared to Permit Connection of 2 or More Links at a Time

2.5" x 11'
SKU 977557
ACSFLT250 **129⁹⁹**

3.5" x 11'
SKU 977589
ACSFLT350 **224⁹⁹**

3" x 11'
SKU 977559
ACSFLT300 **159⁹⁹**

4" x 11'
SKU 977590
ACSFLT400 **244⁹⁹**



3" Y-Assembly Kit with F300 Adapter

SKU 977550
ACSYA300
264⁹⁹



CRUSHPROOF TUBING COMPANY

Door Port Adapters

For 2.5" Hose (Rubber)

SKU 977551
ACSDF25 **59⁹⁹**

- Rubber Garage Door Port Adapter
- Designed for 2-1/2" ID



For 3" Hose (Aluminum)

SKU 977552
ACSADF30 **59⁹⁹**

- Aluminum Port Allows Hose to Be Vented Through the Door



For 4" Hose (Aluminum)

SKU 977554
ACSADF40 **89⁹⁹**

- Use on 1" Thick Doors



2.5" Service Station Kit

SKU 977547
ACSDSS25 **274⁹⁹**

- 2 Each - 4' x 2-1/2" Hoses
- 1 Each - 6' x 2-1/2" Hose
- 1 Each - 2-1/2" Rubber "Y" Connector
- 2 Each - Straight Tailpipe Adapter, Hook and Chain
- 1 Each - Splice Connector



3" Service Station Kit

SKU 977548
ACSDSS30 **279⁹⁹**

- 2 Each - 4' x 3" Hoses
- 1 Each - 6' x 3" Hose
- 1 Each - 3" Rubber "Y" Connector
- 2 Each - Straight Tailpipe Adapter, Hook and Chain
- 1 Each - Splice Connector



Bell Hose Adapters

- Designed for Easy Adapting to All Sorts of Tailpipes
- Connects with Ball and Snap

2.5" Adapter

SKU 977544
ACSRA250 **59⁹⁹**

3" Adapter

SKU 977545
ACSRA300 **59⁹⁹**



SYLVANIA

#1 AFTERMARKET AUTOMOTIVE LIGHTING BRAND IN THE USA¹

NEW!

LED ULTRA + LED FOG + POWERSPORTS BULBS

BRIGHTEST LED³

SYLVANIA LED ULTRA



PERFORMANCE, LONGEVITY + STYLE



BRIGHT LED

SYLVANIA LED



PERFORMANCE + STYLE



¹Circana/U.S. Retail Tracking Service, May 3, 2025 ²See packaging for details ³Compared to SYLVANIA BASIC ⁴Fog or powersports use only

UPGRADE YOUR HEADLIGHTS

BEST

SILVERSTAR ULTRA



FARTHEST DOWNROAD + WHITER LIGHT³

BETTER

SILVERSTAR



FARTHER DOWNROAD + WHITER LIGHT³

GOOD

XTRAVISION



FARTHER DOWNROAD³

SYLVANIA OFF ROAD

LED LIGHT BARS + PODS



LIFETIME LIMITED WARRANTY²

- Superior optical engineering
- Durable design
- Water resistant (IP67 or IP69K)

HID HEADLIGHTS



SYLVANIA HID + XZE HID

- Energy efficient to maximize lifespan.
- High-intensity, bright light
- Tuned for quick warm-up

⚠ Not a replacement for halogen headlights.

AIR CONDITIONING

FOR MORE DETAILS ON RECOVERY MACHINES GO TO AZTOOL1.COM

Recovery Machines

ArcticPRO®



Warranty:
2 Years Parts and 1 Year Labor

MSSACX2180

MAHLE	Refrigerant 134a			Refrigerant 1234yf	
	ACX-2150 R134a Recovery Machine SKU 213170 MSSACX2150	ACX-2180 R134a Recovery Machine SKU 213168 MSSACX2180	ACX-2180H R134a Hybrid Recovery Machine SKU 213203 MSSACX2180H	ACX-2250 R1234yf Recovery Machine SKU 213151 MSSACX2250	ACX-2280 R1234yf Recovery Machine SKU 1187032 MSSACX2280
Automatic Oil Drain	✓	✓	✓	✓	✓
Automatic Air Purge	✓	✓	✓	✓	✓
Included Database	Optional	✓	✓	Optional	✓
Automatic Oil and Dye Injection	✓	✓			
Includes Refrigerant Identifier				✓**	✓*
Phone Application	Optional	✓	✓	Optional	✓
Price	4,449⁹⁹	5,099⁹⁹	5,099⁹⁹	6,299⁹⁹	7,349⁹⁹

On-Board Integrated Thermal Printer (Optional) *Integrated **Non-Integrated

ECOTECHNICS®



Training Videos



Warranty:
1 Year Parts and Labor

HOFEEAC800

Description	Hybrid Ready R134a SKU 1339733 HOFEEAC820B	Hybrid Ready R1234yf SKU 1335790 HOFEEAC830B	Eco Dual Gas A/C Service Station SKU 1335792 HOFEEAC800
Refrigerant Type	R134a	HFO-1234yf	R134a + HFO1234yf
Refrigerant Tank	30 Lb.	30 Lb.	30 Lb. + 30 Lb.
Command Valves	Automatic	Automatic	Automatic
Display	5" Touch	5" Touch	7" Touch
Database	✓	✓	✓
Printer	✓	✓	✓
Status Light	✓	✓	✓
Hybrid Function	✓	✓	✓
Price	4,949⁹⁹	6,599⁹⁹	10,849⁹⁹

KONFORT



Warranty:
2 Years Parts and Labor

TEXA17810

TEXA	750R R134a Recovery Machine SKU 1282745 TEXZ11450	760 R1234yf Recovery Machine SKU 1282756 TEXA17910	780 Dual Gas Recovery Machine SKU 1282809 TEXA17810
Automatic Oil Drain	✓	✓	✓
Automatic Oil and Dye Injection	✓		
10" Multi-Touch Display		✓	✓
R134a Management	✓		✓
R1234yf Management		✓	✓
Vehicle Capacity Database	✓	✓	✓
Software Update Over Wi-Fi		✓	✓
Push-Pull Recovery	✓	✓	✓
Fully Automatic Operation	✓	✓	✓
Price	5,749⁹⁹	10,499⁹⁹	12,999⁹⁹

Prices subject to change without notice. Prices do not include applicable taxes, vehicles, tires, rims, installation or optional equipment as shown. Please do not return purchases to the store. For information regarding warranty, repair, or any questions or concerns, call 901-300-4878.

AIR CONDITIONING

TO ORDER, contact your Commercial Sales Manager or go to AutoZonePro.com

AIR CONDITIONING

Recovery Machines

ROBINAIR



ROBAC1234-9

Warranty:
1 Year Parts and Labor



CPSMSX3030

Warranty:
2 Years Parts and Labor

ARCTIC COMMANDER 2.0

Dust Cover
Included
with All
Machines



Warranty: 1 Year
Parts and Labor

Description	AC1234-4 Premier R1234yf SKU 1212384 ROBAC1234-4	AC1234-9 Connected R1234yf ACS SKU 1212383 ROBAC1234-9	34288NI Economy R134a SKU 221185 ROB34288NI	34788NI-H Premier R134a Refrigerant for Hybrid and Non-Hybrid Vehicles SKU 751572 ROB34788NI-H	34788NI Premier R134a Refrigerant SKU 751569 ROB34788NI	34998 Connected R134a ACS SKU 1212385 ROB34998
Operation	Automatic	Automatic	Semi-Automatic	Automatic Hybrid Vehicle Applications	Automatic Auto Oil Injection	Automatic Auto Oil Injection
Display	4.3" LCD Display	10" Hi-Res Touch Screen	4.3" Full Color Display	4.3" Full Color Display	4.3" Full Color Display	10" Hi-Res Touch Screen
Printer	ROB30038 (optional)	Wireless Printing	ROB30038 (optional)	ROB30038 (optional)	ROB30038 (optional)	Wireless Printing
Bluetooth and Wi-Fi		✓				✓
Call for Price						

cps®	R134a SKU 1407803 CPSMSX134	R1234yf SKU 1407806 CPSMSX1234	R134a/R1234yf SKU 1407510 CPSMSX3030	Heavy Duty R134a SKU 1407805 CPSMXHD
Fully Automatic	✓	✓	✓	✓
Onboard Oil Injection	✓			
High Capacity Oil-less Compressor	✓	✓	✓	✓
Vehicle Database Included	✓	✓	✓	
10 Ft. Service Hoses	✓	✓	✓	18' Hose
Includes 2 Tanks and 2 Sets of Hoses			✓	
Wi-Fi and Bluetooth Enabled	✓	✓	✓	✓
Touch Screen	7" Hi-Res	7" Hi-Res	7" Hi-Res	7" Hi-Res
Includes Refrigerant Identifier		✓	✓	
Converts Between R134a and R1234yf in 10 Min.			✓	
Price	4,989⁹⁹	6,764⁹⁹	8,794⁹⁹	7,619⁹⁹

Mastercool® "World Class Quality"	Semi-Automatic R134a Recovery Machine SKU 1368632 MSC1100	Automatic R134a Recovery Machine SKU 1368636 MSC2100	Automatic R134a Hybrid Recovery Machine SKU 1368634 MSC3100	Automatic R1234yf Hybrid Recovery Machine SKU 1368616 MSC4100
Wi-Fi Capability	✓	✓	✓	✓
Refrigerant Database	Optional	✓	✓	✓
Built-In Tank Heater	✓	✓	✓	✓
Vacuum Pump	3 CFM	6 CFM	6 CFM	6 CFM
Dust Cover	✓	✓	✓	✓
Hose Flushing			✓	✓
Built-In Refrigerant Identifier				✓
Automatic Oil Injection		✓		
E-Printing Capability	Optional	Optional	✓	✓
Price	3,999⁹⁹	4,999⁹⁹	5,299⁹⁹	6,899⁹⁹

Prices subject to change without notice. Prices do not include applicable taxes, vehicles, tires, rims, installation or optional equipment as shown. Please do not return purchases to the store. For information regarding warranty, repair, or any questions or concerns, call 901-300-4878.

AZG0326

AIR CONDITIONING

Recovery Machines

AC519 Plus A/C Service Station, 110V

SKU **OSB**
LAU703030084 **4,699⁹⁹**

- Includes Both R134a and R1234yf Connector Sets in One Package
- User-Selectable Refrigerant Configuration During Initial Startup
- Permanent Refrigerant Assignment Helps Prevent Cross-Contamination
- Fully Automatic Recovery, Vacuuming, Oil Injection and Refrigerant Charging
- Large 10.1" Touchscreen with Intelligent Android-Based Operation



LAUNCH

NEW

R1234yf Twin Turbo Complete Recovery Machine

SKU **34469**
MSC69360-YF **2,149⁹⁹**

- Revolutionary Double Piston Oil-Less Compressor
- Largest Volume Recovery Rate on the Market
- Includes: 30 Lb. DOT Tank, Sight Glass, R1234yf Low Side Coupler, Oil Drain Bottle and R1234yf Blue and Yellow Hoses



Mastercool
World Class Quality

R134a/R1234yf Complete A/C Recovery Set

SKU **OSB**
MSC69372 **2,379⁹⁹**

- Built with the Safest Spark-Free Components
- Includes: All Hoses and Couplers Needed to Recover, Cleanse and Remove the Oil from R134a and R1234yf Automotive A/C Systems
- 30 Lb. DOT Tank for R134a and 30 Lb. DOT Tank for R1234yf Refrigerants Included with Each Unit (Refrigerant Sold Separately)
- 115V/60 Hz
- 1/2 HP Oil-Less Compressor
- Compatible Refrigerants: All CFCs, HCFCs and HFCs



Mastercool
World Class Quality

Recovery Machine Filters/Maintenance Kits

ROBINAIR

CPS

Mastercool
World Class Quality

MAHLE

ECOTECHNICS

TEXA

LAUNCH

SKU	Part Number	Brand	Fits	Price
OSB	ROB34430	Robinair	17700A, 34450, 34700, 34134Z	164.99
OSB	ROB34724	Robinair	34288, 34788, 34788NI, 34788NI-H, 34988, 347002, 341342	119.99
OSB	ROB13172	Robinair	Maintenance Kit for Models Using 34724 Filter - Includes Oil	104.99
OSB	ROB16107	Robinair	1234yf Machine Service Kit	269.99
186483	CPSARXF5	CPS	FX and AR Series CPS Equipment	99.99
1149172	CPSFX3030X1	CPS	Includes FX Series Filter, Vacuum Pump Oil and Coupler O-Rings for FX134A	154.99
199681	MSCCOM1FLTRPK	Mastercool	Commander 4000, 4000x and 4100	169.99
199675	MSCCOM2FLTRPK	Mastercool	Commander 1000, 1100, 2000, 2100, 3000 and 3100	219.99
1149182	MSS3608325400	Mahle	ACX2180, ACX2180H, ACX2286 and ACX2280	149.99
207349	MSS268077600	Mahle	ACX1120H, ACX1150, ACX1150H and ACX2120H	99.99
207508	MSS3608273900	Mahle	ACX1280, ACX2150 and ACX2250	99.99
818739	RTI3608213300	Mahle	RHS980 and ACX1180	104.99
1406968	HOFEEAC33023B	EcoTechnics	HOFEEAC800, HOFEEAC810, HOFEEAC820B and HOFEEAC830B	104.99
OSB	TEX4800380	TEXA	Konfort 760 or 780	244.99
OSB	TEX4800330	TEXA	Konfort 750R	284.99
OSB	LAU503170002	Launch	AC519	49.99
OSB	LAU503170012	Launch	AC519 Plus	49.99

To Confirm Price, Availability and Ordering Instructions on OSB, Call 901-300-4878

Electronic Leak Detection

A/C Refrigerant Leak Detector

SKU **466307**
24510 **119⁹⁹**

Detects All Types of Halogenated Refrigerants

- Sensitive to 0.1 Oz. per Year Single Color LED Display with 7 Level Leak Alarm
- Flexible Stainless Steel Probe to Reach Almost Any Space
- Includes Spare Sensor Tip



OEM TOOLS

Black Series Infrared Refrigerant Leak Detector

SKU **OSB**
MSC55600-A **584⁹⁹**

- Easily Select Sensitivity Levels with a Maximum Sensitivity Up to 0.14 Oz./Yr.
- TFT Screen Provides Clear and Easy Readings That Show Leakage, Sensitivity, Battery Level and Sensor Fault Indicators
- Designed to Meet EN14624, SAE1627, SAE2791 and SAE2913 Standards



Mastercool
World Class Quality

Raptor Refrigerant Leak Detector

SKU **916550**
MSC56100 **259⁹⁹**

- Features 3 Sensitivity Levels and 5 Detection Levels
- Detects Leaks as Small as 1/10 Oz. per Year
- Detects All Refrigerants (CFC, HCFC, HFC)
- Flexible 16" Probe for Hard-to-Reach Areas



Mastercool
World Class Quality

Inspector 2-in-1 Electronic/UV Leak Detector

SKU **916553**
MSC56200 **309⁹⁹**

- Pinpoint Leaks as Small as 1/10 Oz. (3 gr) Per Year
- Built-In Ultra-Bright UV Light at End of Probe - Allowing Easy Access into Tight Areas



Mastercool
World Class Quality

A/C VACUUM PUMP KITS - BETTER VALUE FOR YOUR MONEY

Starter A/C Vacuum Pump Kit - R134a

SKU 1400034
68950

- Includes: 1.8 CFM, 100 Micron Single Stage Vacuum, Professional Quality Extruded Aluminum Manifold with 72" Hoses, High Quality Manual Couplers and R134a Can Tap

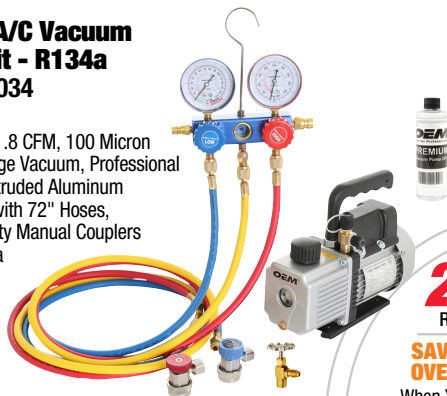

279⁹⁹
REG. \$309.97
SAVE \$29 OVER
When You Buy the Kit

R134a and R1234yf Spark-Free A/C Vacuum Pump Kit

SKU 1400036
68951

- Includes: 6 CFM, 75 Micron, Spark-Free Single Stage Vacuum for Use with R134a or R1234yf, Extruded Aluminum Manifold Gauges, 72" Hoses with High Quality Manual Couplers, R1234yf Conversion Couplers That Convert R134a Manifold and Hoses to R1234yf, 1/2" ACME Right Hand to 1/2" ACME Left Hand Tank Adapter, 1/4" SAE x 1/2" ACME Hose to Vacuum Pump Adapter and R134a and R1234yf Can Tap

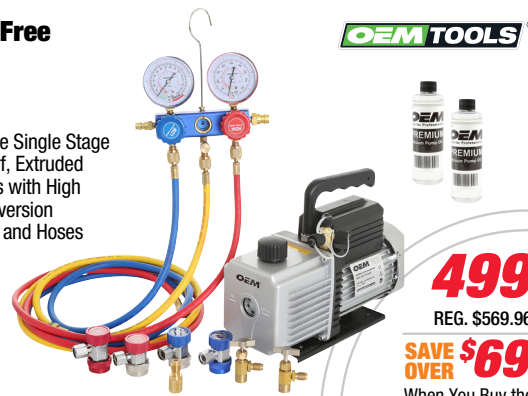

499⁹⁹
REG. \$569.96
SAVE \$69 OVER
When You Buy the Kit

Vacuum Pumps

1.8 CFM Single Stage Vacuum Pump

SKU 466312
24500 **149⁹⁹**

- Motor: 1/4 HP, 110V
- Ultimate Vacuum Rating: 100 Microns
- Inlet Ports: 1/2" ACME - 1/4" Flare
- Oil Capacity: (1) 230 mL Bottle Included
- Internal High Volume Cooling Fan for Extended Use



4 CFM Single Stage Vacuum Pump

SKU 466305
24501 **189⁹⁹**

- Motor: 1/3 HP, 110V
- Ultimate Vacuum Rating: 75 Microns
- Inlet Ports: 1/2" ACME 1/4" Flare
- Oil Capacity: 11 Oz. (330 mL), Included
- Internal High Volume Cooling Fan for Extended Use
- Universal Fit



6 CFM Single Stage Vacuum Pump

SKU 466306
24502 **279⁹⁹**

- Motor: 1/2 HP, 110V
- Ultimate Vacuum Rating: 75 Microns
- Inlet Ports: 1/2" ACME - 1/4" Flare
- Oil Capacity: (2) 230 mL Bottle Included
- Internal High Volume Cooling Fan for Extended Use



6 CFM Spark-Free Vacuum Pump

SKU 213133
24642 **299⁹⁹**

- Motor: Spark-Free 1/2 HP, 110V
- Ultimate Vacuum Rating: 75 Microns
- 3 Inlet Ports: 1/4" Flare, 1/2" ACME and 1/2" ACME LH
- Oil Capacity: (2) 230 mL Bottle Included
- Internal High Volume Cooling Fan for Extended Use
- Can Be Used with R1234yf Refrigerant



3 CFM Single Stage Vacuum Pump

SKU 1392324
MSC290062 **199⁹⁹**

- Large Fan Keeps Vacuum Pump Cooler and Extends Life
- 1/4" SAE and 1/2" ACME Port Access
- 110-120V, 60 Hz Voltage



R1234yf Manifold/Hose Adapter Assortment

SKU 1142732
25091 **32⁹⁹**

- 6 Common Adapters to Fit Manifolds, Hoses, Couplers and Vacuum Pumps
- Includes: 1/2" LH ACME Female x 1/4" Male Flare, 1/2" ACME Male x M12 x 1.5 Male, 1/2" ACME Female x M12 x 1.5 Female, 1/4" Male Flare x M12 x 1.5 Male, 1/2" LH ACME Female x M14 QDK, 1/2" LH ACME Male x 1/4" Female Flare
- Includes: Organizer Case with I.D. Labels



Vacuum Pump Oil (8 Oz.)

SKU 363429
24399 **10⁰⁰**

- Increases Life Span of the Pump
- Performance of Your Pump Depends on Regular Service and the Quality and Purity of the Vacuum Pump Oil That You Use
- Compatible for Use in Pumps Made by Most Manufacturers

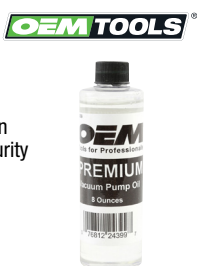

Premium Vacuum Pump Oil 1 Quart Bottle

SKU 517580
CPSVPOQ12 **19⁹⁹**

- Increases Life Span of the Pump
- Performance of Your Pump Depends on Regular Service and the Quality and Purity of the Vacuum Pump Oil That You Use
- Compatible with Most Pumps



R1234yf Hose to Vacuum Pump Adapter Fitting 1/4" x 1/2"

SKU 600806
24509 **19⁹⁹**

- 1/4" SAE x 1/2" ACME Female LH Thread



STORE STOCKED

AIR CONDITIONING

Manifold Gauges

R1234yf Manifold Gauge and Hose Set

SKU 752518 **199⁹⁹**
24559

- 3" Easy-to-Read Gauges with Temperature Chart
- 72" Hoses
- High Quality 6-Ball Manual Couplers

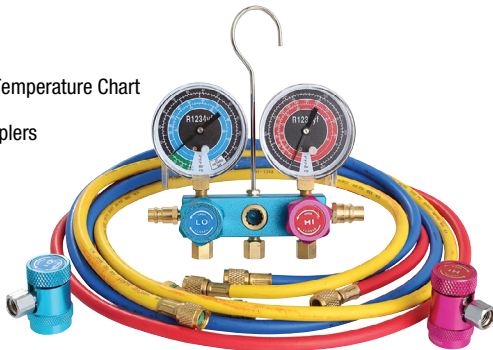

OEM TOOLS®

Dual Aluminum R134a/R1234yf Gauge Set

SKU 1335797 **239⁹⁹**
25130

- Includes: 72" Hoses, Manual Couplers and Can Tap Valves with 1/2" ACME Fittings for Use with Both R134a and R1234yf Refrigerants

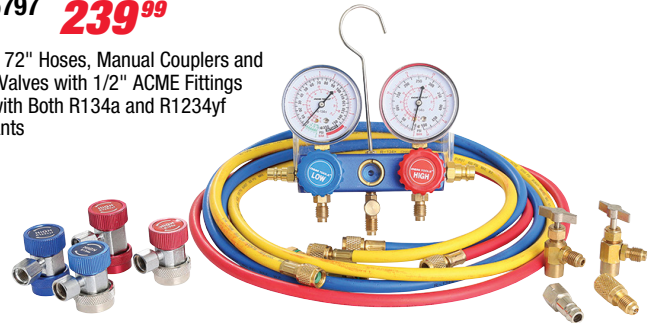

OEM TOOLS®

R134a Brass Manifold Gauge Set

SKU 752520 **129⁹⁹**
24563

- High Quality Brass Body with Sight Glass
- Large 2-1/2" Gauges are Easy to Calibrate and Have a High Impact Lexan Lens
- 60" Hoses (3,000 psi Burst, 600 psi Working Pressure)
- Snap Style Quick Couplers

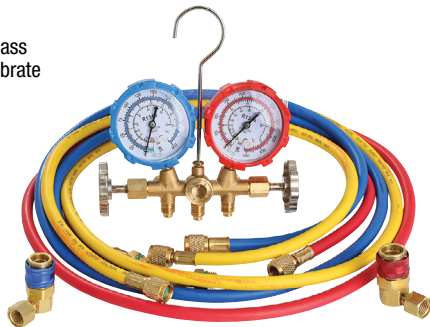

OEM TOOLS®

R134a Manifold Gauge and Hose Set

SKU 466319 **144⁹⁹**
24527

- Easy-to-Read 2-3/4" Spring Dampened Gauges to Reduce Flutter
- Extruded Aluminum Manifold
- 72" Hoses with Manual Couplers

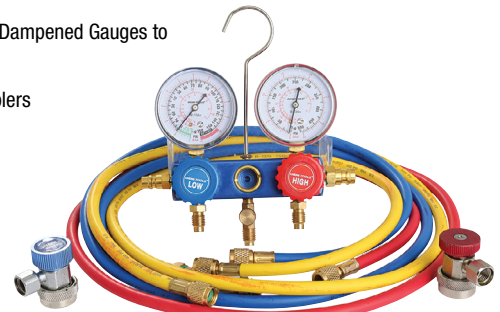

OEM TOOLS®

Dual R134a, R-12 Manifold Gauge Set

SKU 1335804 **131⁹⁹**
MSC293996PBCL

- Solid Block Extruded Aluminum Manifold
- 96" Long Hoses with Manual Couplers
- Gauge Guards for Protection
- Silicone Dampened Calibratable Gauges
- Extra Long Hose for Access to Heavy Duty Buses, Fleet and Refrigerated Trucks Systems

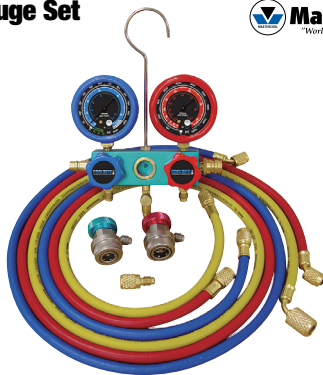

Mastercool®
"World Class Quality"

Dual R134a/R1234yf Brass Gauge Set

SKU 1142631 **182⁹⁹**
MSC66661AYF

- 2-1/2" Silicone Dampened, Recalibrateable Gauges
- Extra Access Port for Vacuum Line
- R1234yf High and Low Side Quick Couplers
- R134a High and Low Side Economy Couplers
- 1/2" ACME-M x 1/2" ACME-F LH Thread Adapter (2) 12 mm-M x 14 mm-F R1234yf Adapters Set of 3 - R134a Standard Hoses



Mastercool®
"World Class Quality"

R1234yf Aluminum Manifold Gauge Set

SKU 505065 **274⁹⁹**
MSC83272

- Ideal for Shops That Want to Wait to Invest in New AC Service Stations Adapted for R1234yf
- Contains Manifold, 3 Service Hoses, 2 Service Couplers LT/HT

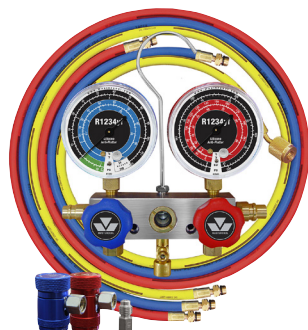

Mastercool®
"World Class Quality"

Dual Aluminum R134a/R1234yf Gauge Set

SKU 1086254 **316⁹⁹**
MSC89661AYF

- Professional Extruded Aluminum Block
- 2-1/2" Silicone Dampened, Re-Calibrateable Gauges
- Free-Floating Piston Type Valves Reduce O-Ring Wear
- R1234yf High and Low Side Couplers with Extended Disconnect Protection Sleeve
- Standard Hoses, R134a Manual Couplers, R1234yf Couplers, 1/2" ACME-M x 1/2" ACME-F LH Thread Adapter, (2) 12 mm-M x 14 mm-F R1234yf Adapters



Mastercool®
"World Class Quality"

Prices subject to change without notice. Prices do not include applicable taxes, vehicles, tires, rims, installation or optional equipment as shown. Please do not return purchases to the store. For information regarding warranty, repair, or any questions or concerns, call 901-300-4878.

Can Taps

OEM TOOLS®

R1234yf Self-Sealing Can Tap

SKU 213178 **14⁹⁹**
24553



R134a Can Tap

SKU 466315 **14⁹⁹**
24524

4-Way Side Can Tap

SKU 1103203 **34⁹⁹**
FJC6842

- For Use with R-12, R134a or R1234yf Refrigerant Cans and Oil Charge Cans
- Fits Cans with 2-7/8", 2-1/2" and 2" Diameter
- Includes: 1/2" ACME LH, 1/2" ACME and 1/4" Flare Male Fitting with Check Valve



FJC
Air Conditioning Products
Tools and Equipment

Refrigerant and Oil Charge Side Can Tap

SKU 466313 **19⁹⁹**
24523

- Fits 1 Lb. Cans of R134a, R12 and 2" Oil Charge Cans
- Plier Type Grip with Positive Lock
- Includes: 1/2" ACME Male and 1/4" FL Male Ports with Safety Valve



OEM TOOLS®

Manifold Gauge Repair

OEM TOOLS®

Replacement Gauge High Side for A/C Manifold

SKU 481705 **10⁹⁹**
24530

- Replacement High Side Gauge Fits OEMTOOLS® and Other Brands of A/C Manifolds Used to Service A/C Systems on Cars
- 1/8" NPTF Male Threads
- Reads 0 to 500 psi



A/C Manifold Upgrade Kit

SKU 1043688
68903

- Includes: 3-in-1 Side Mount Can Tap Valve, R134a Manual Coupler Set, 1234yf Self Sealing Can Tap, 1/2" ACME Hose Set 72", R134a to HFO-1234yf Conversion Coupler Set

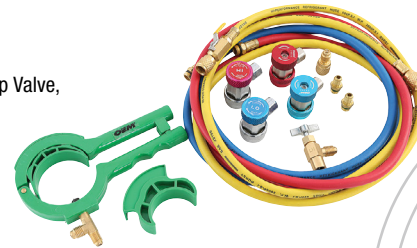

OEM TOOLS®

139⁹⁹

REG. \$199.95

SAVE \$59 OVER

When You Buy the Kit

Replacement Gauge Low Side for A/C Manifold

SKU 481709 **9⁹⁹**
24531

- Reads 0 to 120 psi and 0 to 30" Hg

OEM TOOLS®



R1234yf Manifold/Hose Adapter Assortment

SKU 1142732 **32⁹⁹**
25091

- 6 Common Adapters to Fit Manifolds, Hoses, Couplers and Vacuum Pumps
- Includes: 1/2" LH ACME Female x 1/4" Male Flare, 1/2" ACME Male x M12 x 1.5 Male, 1/2" ACME Female x M12 x 1.5 Female, 1/4" Male Flare x M12 x 1.5 Male, 1/2" LH ACME Female x M14 QDK, 1/2" LH ACME Male x 1/4" Female Flare
- Includes: Organizer Case with I.D. Labels



OEM TOOLS®

R134a/R12 Charging Hose Repair Kit

SKU 295557 **28⁹⁹**
MSC91334-A

- 50 Piece Assortment of Replacement Gaskets, O-Rings, Depressors for Charging Hoses and Adapters



Mastercool®
World Class Quality™

72 Piece Valve and Gasket Set

SKU 1544670 **17⁹⁹**
25099

- Includes: 50 Common Gaskets for 134a Hoses and Manifold Sets, 10 Replacement Valves and 10 Replacement Valve Cores
- Includes: Valve Core Replacement and Installation Tool and Organizer Case



OEM TOOLS®

A/C Hoses

Mastercool®
World Class Quality™

96" R134a Red Hose

SKU 489152 **34⁹⁹**
MSC84963

- 1/2" ACME-F and 14 mm-M Auto A/C Fittings - 96"



96" R134a Blue Hose

SKU 489151 **34⁹⁹**
MSC84961

- 1/2" ACME-F and 14 mm-M Auto A/C Fittings - 96"



72" R134a Hose Set

SKU 752516 **59⁹⁹**
24558

- 3 Color Coded Hose: Red, Yellow and Blue

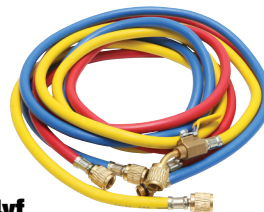

96" 2 Piece 1234yf Recovery Hose Set

SKU 85829 **36⁹⁹**
25010

- Includes: 96" Set Blue/Red 12 mm-M x 12 mm-M
- Meets or Exceeds SAE J2888 Standards

72" 1/4" SAE Hose Set

SKU 752515 **46⁹⁹**
24557

- 3 Color Coded Hose: Red, Yellow and Blue



72" 3 Piece R1234yf Hose Set

SKU 85803 **42⁹⁹**
25009

- Includes: (2) 72" High/Low Charging Hoses with 12 mm Male Fittings and 72" Charging Hose with 12 mm and 1/2" x 16" Left Hand Acme Fitting
- Meets or Exceeds SAE J2888 Standards

OEM TOOLS®

AIR CONDITIONING

A/C Service Tools

A/C Condenser Fin Comb Straightener/Cleaner

SKU 466317 **8⁹⁹**
24526

- Clean and Straighten Condenser and Evaporator Coils
- Compact Design for Confined Spaces
- 6 Clearly Marked Combs: 8, 9, 10, 12, 14 and 15 Fins per Inch

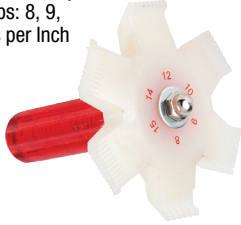

Valve Core Tool Set (2 Piece)

SKU 1209377 **9⁹⁹**
22589

- Designed for Removal and Installation of Schrader Style Valve Cores



A/C Clutch Holding Tool

SKU 1392339 **19⁹⁹**
26550

- Holds Compressor Clutch in Place When Removing the Holding Bolt
- Adjustable Pins to Fit Various Compressor Clutches
- Compatible with Domestic and Import Vehicles



A/C Clutch Hub Puller and Installer

SKU 1103539 **89⁹⁹**
37150

- Features All the Tools Necessary to Remove and Install Pressed on A/C Clutch Hubs on Many Domestic and Import Vehicles
- Includes Orifice Tube Extractor Tool Set

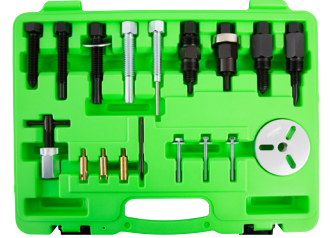

A/C Couplers

R134a Manual Coupler Set

SKU 362980 **39⁹⁹**
24396

- All Metal Construction for Extra Durability
- 6-Ball Coupler for Secure Grip
- Includes Adapter for Use with R12 Hoses

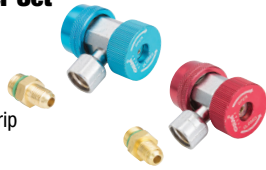

R134a High Side Manual Coupler

SKU 347267 **23⁹⁹**
24395

R134a Low Side Manual Coupler

SKU 347266 **23⁹⁹**
24394

1234yf Manual Coupler Set with 134a Hose Adapters and Acme Adapter

SKU 1544682 **49⁹⁹**
25093

- Couplers Have 12 mm F Threads to Connect to 1234yf Hose Connections
- Two 12 mm M to 14 mm F Brass Adapters Included for Use with 134a Hoses
- Includes 1/2" M to 1/2" F Left Hand Acme Adapter



R1234yf High-Side Coupler

SKU 1544684 **29⁹⁹**
25094

- Includes R134a Adapter

R1234yf Low-Side Coupler

SKU 1544686 **29⁹⁹**
25095

- Includes R134a Adapter

R134a Extra Long Coupler

SKU 752517 **29⁹⁹**
24556

- Used on BMW E60 (2003-2009 5 Series) and Some Volvo Models
- Allows for A/C Service with No Radiator Removal



R134a Refrigerant Tank Adapter

SKU 850565 **19⁹⁹**
24554

- Male Low-Side R134a to Female 1/2" ACME
- Attaches to Virgin Tank and Low-Side Service Coupler



R1234yf Low Side Tank Adapter

SKU 1103204 **19⁹⁹**
25086

- Used to Fill Refrigerant from R1234yf Cylinders
- Attaches to Virgin Tank and Low Side Service Coupler
- This Fitting Does Not Have a Valve Core or Valve Core Depressor



R1234yf Hose to Vacuum Pump Adapter Fitting 1/4" x 1/2"

SKU 600806 **19⁹⁹**
24509

- 1/4" SAE x 1/2" ACME Female LH Thread



Valve Core Tools

A/C Valve Core Tool

SKU 466314 **14⁹⁹**
24555

- Double-Ended Valve Core Tool to Service Both Standard and Large Bore R134a and R12 Cores



OEM TOOLS®

A/C Valve Core Removal Tool R134a, R1234yf

SKU OSB **58⁹⁹**
44891

- Removes and Installs A/C Valve Core without Refrigerant Loss
- Heavy-Duty Brass and Aluminum
- Integrated Ball Valve Lets You Shut Off Refrigerant Flow During Core Removal or Installation for Safer, Cleaner Service
- Includes Sturdy Blow Mold Case

OEM TOOLS®

NEW



Works with Standard, JRA and Schrader Valve Cores



For OSB, Call 901-300-4878

Universal Valve Core Remover/Installer for R1234yf

SKU 1043686 **148⁹⁹**
MSC58490-YF

- Attaches to R1234yf Service Ports to Quickly and Easily Remove and Replace Valve Cores without the Loss of Refrigerant
- Ball Valve Design with Stainless Steel Ball Provides Smooth Movement and Durability
- Kit Covers 17 mm and 14 mm High and Low Side Service Ports
- Includes: Valve Assembly, High Side 17 mm Connector, Low Side 14 mm Connector, Standard Valve Core Shaft, GM Large Bore Valve Core Shaft and Eaton R134a/R1234yf High Side Valve Core Shaft



Mastercool®
World Class Quality

Universal Valve Core Remover/Installer for R134a/R12

SKU 1142576 **241⁹⁹**
MSC58490

- Kit Covers All R12 and R134a System Valve Cores for Standard, JRA, Eaton and GM Large Bore
- Includes: Valve Assembly, R134a High Side 16 mm Connector, R134a Low Side 13 mm Connector, 1/4" FL Swivel Connector, Adapter 1/4"-M x 3/16"-F High Side GM/Ford, Adapter 1/4"-M x 1/8"-F High Side Ford and Blow Mold Case



Mastercool®
World Class Quality

SpotGun® Jr.

SpotGun® Jr. Univ. Oil/UV Dye Kit for R134a/R1234yf - 1 Oz.

SKU 1368623 **214⁹⁹**
UVU390100

- Works with Both R134a and R1234yf Refrigerant Systems
- 4 Universal Oil Cartridges (1 Oz.)
- 2 ExtenDye™ Cartridges (1 Oz.)
- 2 LeakGuard™ OneShot Cartridges (1 Oz.)
- 2 Low-Side Service Adapter Hoses and R134a/R1234yf Couplers



SpotGun® Jr. Univ. Oil/UV Dye Kit for R134a/R1234yf - 1 Oz. with UV Lite

SKU 1400039 **274⁹⁹**
UVU390200

- Works with Both R134a and R1234yf Refrigerant Systems
- Includes: UV Phazer (AAA) UV Lite and UV Enhancing Glasses
- 4 Universal A/C Oil (1 Oz.)
- 2 ExtenDye™ Cartridges (1 Oz.)
- 2 LeakGuard™ OneShot Cartridges (1 Oz.)



A/C ExtenDye™ Cartridge

- SAE J2297 Certified Super Concentrated UV Dye
- Works in R134a, R1234yf Systems and is Hybrid Safe
- Contains Friction Modifier to Increase Lubricity and Decrease Friction
- Contains Antioxidant to Prolong Oil Life
- Anti-Wear Additive for Better Wear Resistance
- Works with SpotGun® Jr. Injection System

A/C ExtenDye™ Cartridge 1 Oz. (4 Pack)

SKU 1362004
UVU399020A

59⁹⁹



A/C ExtenDye™ Cartridge .25 Oz. (6 Pack)

SKU OSB
UVU399006A

34⁹⁹



Universal PAG 46 Oil for R134a - 1 Oz. Cartridge (12 Pack)

SKU OSB **78⁹⁹**
UVU399046

- OEM Approved
- Works with SpotGun® Jr. Injection System
- Formulated to Work with R1234yf, R134a and Hybrid Safe
- Sealed Cartridge Assures Clean Oil Delivered to Vehicle A/C System
- Injection System Measures the Correct Dosage



Universal PAG 46 Oil R1234yf - 1 Oz. Cartridge (4 Pack)

SKU OSB
UVU399046YFPK

28⁹⁹

To Confirm Price, Availability and Ordering Instructions on OSB, Call 901-300-4878

SpotGun®

SpotGun® Univ. Oil/Dye Kit for R134a/R1234yf - 8 Oz. without UV Lite

SKU OSB **184⁹⁹**
UVU490100

- Works with Both R134a and R1234yf Refrigerant Systems
- 1 Universal Oil Cartridge (8 Oz.)
- 1 ExtenDye™ Cartridge (8 Oz.)
- Service Maintenance Stickers
- 2 Low-Side Service Adapter Hoses and R134a/R1234yf Couplers



SpotGun® Univ. Oil/Dye Kit for R134a/R1234yf - 8 Oz. with UV Lite

SKU OSB **264⁹⁹**
UVU490200

- Works with Both R134a and R1234yf Refrigerant Systems
- 1 Universal Oil Cartridge (8 Oz.)
- 1 ExtenDye™ Cartridge (8 Oz.)
- UV Phazer™ Black (AAA Batteries Included) UV Enhancing Glasses



A/C ExtenDye™ Cartridge - 8 Oz.

SKU OSB
UVU499108A

72⁹⁹

- Works in R134a, R1234yf Systems and is Hybrid Safe
- Contains Friction Modifier
- Contains Antioxidant to Prolong Oil Life
- Fits Competitive Guns



Mastercool

Professional UV Leak Detection Kit with 12V/50W UV Light

SKU 290041 **96⁹⁹**
MSC53351

- 12 Volt/50 Watt UV Leak Detector
- 1 Oz. Coolant Dye, 1 Oz. Oil/ATF/Fuel Dye, Dye Remover
- Mini Dye Injector (10 Applications of Universal A/C Dye) Compatible with R134a and R12 Adapter
- UV Enhancing Safety Glasses
- 12 Service Labels



Universal Concentrated Dye Cartridge 1 Oz. (5 Pack)

SKU 505040 **80⁹⁹**
MSC53810-5

- 5 Pack of Dye for 53585 Leak Detector Kit
- 10 Applications per Bottle



AIR CONDITIONING

UV Leak Detection Lights

13.4" Multi-Use Rechargeable Diagnostic Under-the-Hood Work Light

SKU 591153 24609 **152⁹⁹**

- 5 Hr. Run Time on High



OEM TOOLS

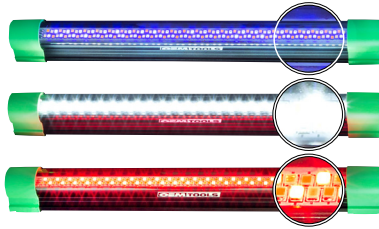

UV Leak Dye Detection Light

400 Lumens Super Bright Work Light

Yellow Smoke Detection Light

Rechargeable UV Flashlight

SKU 1544660 MSC53518UV **111⁹⁹**

- High-Intensity LED Ensures Superior Illumination for Accurate Leak Detection
- 2W Lamp Power: Provides Powerful Performance In a Compact Design
- UV Intensity: 154–170 $\mu\text{W}/\text{cm}^2$, Comparable to a 50-Watt UV Flashlight
- UV Wavelength: Operates At 390–400 Nm for Optimal Detection
- Rechargeable Battery: Delivers 3 to 5 Hours of Continuous Use
- Backup Power Option: Includes Holder and 3 AAA Batteries



Mastercool
"World Class Quality"

UV Phazer Professional 395nm Leak Detection Light

- Adjustable Zoom Lens Allows for Focusing Light Intensity In a Smaller/Larger Area for Precision Viewing
- Rechargeable Li-ion Battery

Black

SKU 1405963 UVUEW40395 **85⁹⁹**

- High Output True UV LED Light
- Precise, True UV Wavelength and Bandwidth to Optimize the Fluorescence of UV Dyes
- Max. Run Time: 4 Hrs.



NEO

SKU 1400042 UVUEW50395 **154⁹⁹**

- UV Dye Shines Brighter with the Phazer Neo Than Any Other UV Light
- Water Resistant
- Max. Run Time: 5 Hrs.



VIEW

UV Leak Detection Light and Glasses

SKU 213144 24516 **34⁹⁹**

- Compact UV Leak Detection Pen Light
- Can Be Used with All Types of UV Leak Detection Dyes
- Yellow Lens Protective Glasses Enhance Visibility of Leaks



OEM TOOLS



2 AA

Magnifying Glass with 5 LED and 1 UV Light

SKU 191688 25465 **23⁹⁹**

- Compact Magnifier with 5 LED Lights and a Super Bright UV Light
- UV Light Detects Dyes



OEM TOOLS

Refillable Injectors

In-Line Dye and Oil Injector

SKU 466322 24532 **43⁹⁹**

- Add Up to 2 Oz. of Oil or Dye to a System Under Vacuum or While Adding Refrigerant
- 1/2" ACME Fittings to Fit Most R134a Systems
- Use with UVU499008A A/C ExtenDye™ Bottle (8 Oz.)



OEM TOOLS

R12 and R134a Hand Turn Dye Injector

SKU 466320 24528 **98⁹⁹**

- Injects Dye or Oil into R12 or R134a Systems
- Refillable, Capacity: 2 Oz.
- Includes: R134a Quick Coupler
- Use with UVU499008A A/C ExtenDye™ Bottle (8 Oz.)



OEM TOOLS

R1234yf Hand Turn Oil and Dye Injector

SKU 213158 24517 **94⁹⁹**

- Easy to Operate Hand Turn Injection
- Durable Aluminum Construction with Laser Etched Filling Guide
- Includes: R1234yf System Coupler
- 2 Oz. (60 mL) Capacity
- Use with UVU499008A A/C ExtenDye™ Bottle (8 Oz.)



OEM TOOLS

Refillable Universal Dye Injector for R1234yf

SKU 764999 MSC53123-YF **164⁹⁹**

- Heavy Duty Aluminum Construction
- Injects Dye or Oil into R1234yf Systems
- Refillable, Any Dye or Oil Can Be Used
- Easy Twist Injection System
- Precise Injection Control



Mastercool
"World Class Quality"

Pourable Dyes

A/C ExtenDye™ Bottle - 8 Oz.

SKU OSB UVU499008A **59⁹⁹**

- SAE J2297 Certified Super Concentrated UV Dye
- Works in R134a, R1234yf Systems and is Hybrid Safe
- Contains Friction Modifier to Increase Lubricity and Decrease Friction
- Contains Antioxidant to Prolong Oil Life
- Anti-Wear Additive for Better Wear Resistance



VIEW

For OSB,
Call 901-300-4878

Multi-Purpose Dye - 1 Oz. Bottle (6 Pack)

SKU 1392316 UVUB483206 **48⁹⁹**

- Detects Leaks in Hydraulic Systems, Engine Crank Case, Power Steering Systems, Fuel Systems and Transmission
- Includes 6 Bottles (1 Oz./30mL)
- Service Stickers Included



AIR CONDITIONING

TO ORDER, contact your Commercial Sales Manager or go to AutoZonePro.com

AIR CONDITIONING

Orifice Tube

OEM TOOLS®

26 Piece Master Orifice Tube Assortment

SKU 851868 **30⁹⁹**
24564

- Covers Most Vehicles That Require Air Conditioning Orifice Tubes
- Includes: Chrysler (Orange, Purple T-Top), Ford (Black, Blue, Brown, Green, Red), GM (Black T-Top, White, Yellow), Jeep (Green - White) and Volvo (Yellow)



A/C O-Ring Assortment

HARDWARE
MACHINERY

270 Piece A/C HNBR O-Ring Kit

SKU 271196 **11⁹⁹**
68141

- Great O-Ring Set for Most Automotive and Refrigerant Applications

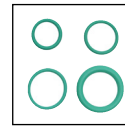

Kit Contains 270 O-Rings in a Variety of SAE Sizes



Digital Scales

Digital Refrigerant Scale (240 Lb. Capacity)

SKU 752521 **216⁹⁹**
24560

- High-Visibility .75" x 2.5" LCD Backlit Display
- 3 Units of Measure: Kg/Oz./Lb.
- Automatic Shut-Off After 10 Minutes, Backlight Will Shut Off After 3 Minutes
- Fully Enclosed and Removable Metal Scale Platform Enables Use of Product in or Out of the Protective Case



Black Series Electronic Charging Scale with Bluetooth

SKU 290029 **304⁹⁹**
MSC98210-BL

- Includes: Bluetooth Wireless Technology
- Capacity: 243 Lb.
- Accuracy: $\leq \pm 0.05\%$ of Reading
- Resolution: 0.05 Lb./0.5 Oz./0.01 kg
- Rugged, Non-Slip Platform



Mastercool®
"World Class Quality"

A/C Flush

cps®

A/C Flush Machine

SKU OSB
CPSAFM100

1,749⁹⁹

- Air Operated 8' Hoses to Reach Any System
- Forward or Reverse Flush without Changing Hoses
- 2-1/2 Gallon Capacity Tank for Use on Cars and Buses
- Universal Couplers Allows Connection to Most Types of Connections
- Clear Filter Bowl Allows You to See What is Coming Out of the System with a Cleanable Filter



For OSB, Call 901-300-4878

MASTERCLEANSE A/C Flush Machine

SKU 34468 **879⁹⁹**
MSC69900

- Designed to Flush All HVAC/R and Automotive Systems
- Pump Power: 0.4 HP; Flow Rate: 4 Gal/Min.
- Stainless Steel Ball Valve Controls
- 1/4" SAE Connection
- Pump Equipped with Mechanical Seal and PTFE Gasket
- 110 VAC



Mastercool®
"World Class Quality"

Adapter Kit

SKU 481575 **144⁹⁹**
MSC69925

- Isolates A/C System Components for Closed Loop Flushing
- Flush Individual Components without Removing Them from the Vehicle
- Install Adapters on A/C Line Ends to Allow Attachment of Flushing Equipment



A/C Flush Kit

SKU 1103579 **84⁹⁹**
37377

- Uses Shop Air to Pressurize the Solvent to Thoroughly Clean the System
- Simple, Effective and Easy to Use
- Attached Nozzle Directs the Solvent without Sprayback
- Includes: Canister, Hose, Blowgun, Rubber Tip and Cylinder Cap
- Solvent Purchased Separately



OEM TOOLS®

A/C Flush Solvent

Bottle (32 Oz.)

SKU 695650 **18⁹⁹**
MSC91049-32

1 Gallon

SKU 695653 **55⁹⁹**
MSC91049-128



Mastercool®
"World Class Quality"

MSC91049-32

MSC91049-128

Prices subject to change without notice. Prices do not include applicable taxes, vehicles, tires, rims, installation or optional equipment as shown. Please do not return purchases to the store. For information regarding warranty, repair, or any questions or concerns, call 901-300-4878.

AIR CONDITIONING

A/C Hose and Line Repair

Heavy Duty Ratcheting Hose Cutter

SKU 466311 **19⁹⁹**
24522

- Smooth Action and High Quality Blade Provide Quick, Clean and Accurate Cuts
- Ratcheting Action Makes it Faster and Easier to Use than Other Cutters
- Cuts Rubber Hose and PVC Up to 1-1/2" OD
- Wide Hooked Jaws Hold Tubing Securely



OEM TOOLS®

Manual Style A/C Hose Crimper, Bench or Vise Mounted

SKU 290028 **359⁹⁹**
MSC71550

- Manual Style A/C Hose Crimper
- Mount to Bench Using Holding Fixture or Place in Vise
- Includes: 71500 - 001 Yoke Assembly, 71550 - 002 Arbor Assembly, 71550 - 003 Holding Fixture Assembly, 71500 - 6 Die Set - #6 (5/16"), 71500 - 8 Die Set - #8 (13/32"), 71500 - 10 Die Set - #10 (1/2"), 71500 - 12 Die Set - #12 (5/8") and 71500-PB Custom Mold Box Carrying Case

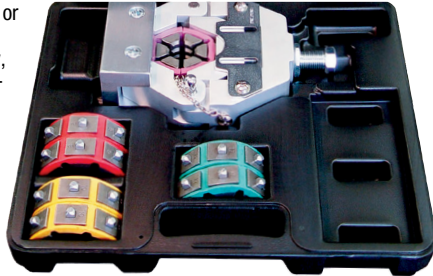

Mastercool®
"World Class Quality"

Thermometers

Non-Contact Infrared Thermometer

SKU 951642 **44⁹⁹**
25245

- Point-and-Click Non-Contact Thermometer Uses a Laser Pointer to Give Precise Temperature Readings Ranging from -58°F to 716°F (-50°C to 380°C)
- Laser Pointer Identifies the Spot to Be Measured and Provides Accurate Temperature Measurements from a 12:1 Distance-to-Spot Ratio (Emissivity 0.95 Preset)
- Lightweight and Easy to Operate with an LCD Backlit Display That Makes it Effective Even in Low Light Situations
- Auto Power-Off Feature Conserves Battery Power by Shutting Thermometer Off After 7 Seconds of Non-Use
- 9V Battery Included (Typical Battery Life: 22 Hours in Non-Laser Mode, 12 Hours in Laser Mode)



OEM TOOLS®

Thermal Imaging Camera

SKU 213193 **249⁹⁹**
24552

- Temperature Range: -4°F to 1,202°F (-20°C to 650°C), Selectable Temperature (C or F)
- Captures Thermal Images and Saves to MicroSD Card (Not Included)
- 3 Selectable Color Palettes
- 1.8" LCD Color Display
- Includes: Storage Pouch and Mini USB Cable



AirSept® Line Repair

SAVE TIME & MONEY!

CERTIFIED LEAK-FREE

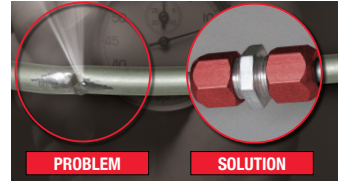

15 X 09
AIRSEPT
PART SMART

FIX or TERMINATE a Line in 5 MINUTES!

UP TO 2,600 psi

OE-APPROVED REPAIR SOLUTION INSTALLS IN MINUTES, NO SPECIAL TOOLS, NO GLUE

Line Terminator SAE (5 Pack)

SKU 504122 **109⁹⁹**
AIR76526

- Quickly and Effectively Blocks A/C Lines at the Damage Point or at the Front System "Y"
- Block Off Leaking Rear Evaporators and Failed System Components
- Include One Each: 5/16", 3/8", 1/2", 5/8" and 3/4" SAE Kits



Line Terminator SAE/Metric (10 Pack)

SKU 504124 **203⁹⁹**
AIR76530

- Quickly and Effectively Blocks A/C Lines at the Damage Point or at the Front System "Y"
- Block Off Leaking Rear Evaporators and Failed System Components
- Includes: One Each: 5/16", 3/8", 1/2", 5/8", 3/4", 8 mm, 10 mm, 12 mm, 15 mm and 16 mm

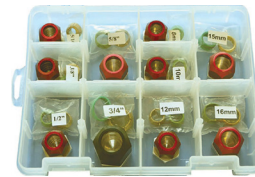

Line Splice Straight SAE/Metric (10 Pack)

SKU 504103 **299⁹⁹**
AIR76051

- Includes: One Each: 5/16", 3/8", 1/2", 5/8", 3/4", 8 mm, 10 mm, 12 mm, 15 mm and 16 mm



Line Terminator Rear A/C Blockoff Kits

- Quickly and Effectively Blocks A/C Lines at the Damage Point or at the Front System "Y"
- Block-Off Leaking Rear Evaporators and Failed System Components
- Help Maximize Front A/C Performance
- Eliminate Refrigerant and Oil Pooling in Rear A/C Lines



SKU	Part #	Size	Price
504149	AIR76502	3/8" Line	26.99
504146	AIR76501	1/2" Line	26.99
504150	AIR76503	5/16" Line	26.99
504152	AIR76504	5/8" Line	30.99
504154	AIR76505	3/4" Line	35.99
329221	AIR77508	8 mm OD Line	26.99
329219	AIR77510	10 mm OD Line	26.99
329231	AIR77515	15 mm OD Line	30.99
329230	AIR77516	16 mm OD Line	30.99

Line Splice Straight Repair Kit

- High-Tech Anti-Vibration Tension Ring Ensures Durability in Tough Automotive Applications
- HNBR Seal Sleeve Dramatically Expands the Sealing Surface Area
- Burst Tested to 2,600 psi



SKU	Part #	Size	Price
504140	AIR76003	5/16" Line	35.99
504138	AIR76002	3/8" Line	35.99
504136	AIR76001	1/2" Line	35.99
504143	AIR76011	5/8" Line	44.99
504132	AIR77008	8 mm Line	35.99
504155	AIR77010	10 mm Line	35.99

Smart Splice™ Line to Hose

- Leak-Proof Line Splice™ Technology on the Metal Side of the Connection
- Superior Hose Crimp Technology on the Rubber Side
- Also Works for Heater and Coolant Lines
- Install in 5 Minutes



SKU	Part #	Size	Price
504125	AIR76701	1/2" Line to #8 Hose	29.99

ALLDATA®

ALLDATA REPAIR® & ALLDATA COLLISION® + ALLDATA ESTIMATOR

Fast-Track Estimates & Order AutoZone® Parts

NEW!
ALLDATA ESTIMATOR
NOW INCLUDED
WITH YOUR
SUBSCRIPTION

- Quickly create professional, compliant estimates
- Easily add parts & labor costs directly from ALLDATA Repair or ALLDATA Collision
- Store customer and vehicle data, including custom jobs
- Customize the estimate with your shop's logo
- Order AutoZone parts directly from the catalog

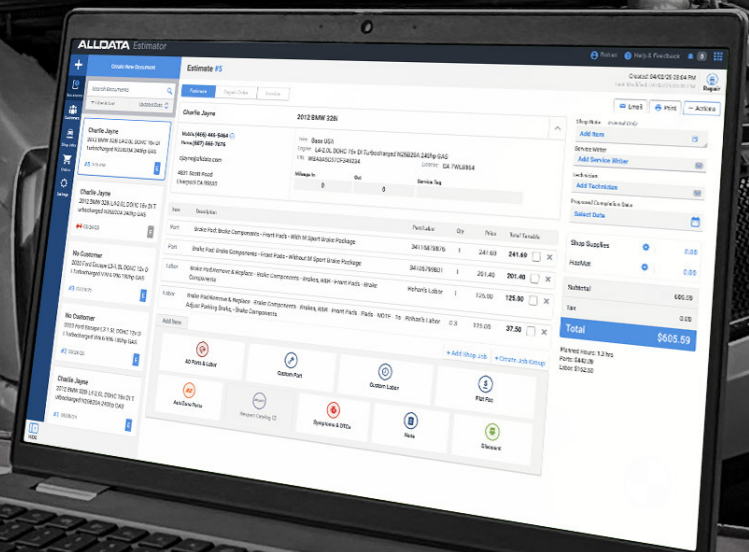

(888) 726-3211

For our latest pricing and promotions visit
ALLDATA.com

©2016 ALLDATA LLC. ALLDATA, Automotive Intelligence, ALLDATA Repair, ALLDATA Collision, ALLDATA Shop Manager, ALLDATA Tech-Assist and ALLDATA Mobile are registered trademarks and ALLDATA Manage, ALLDATA Community and ALLDATA Estimator are marks of ALLDATA LLC. AutoZone is a registered trademark of AutoZone IP LLC. All other marks are property of their respective owners.

DIAGNOSTICS

TOPDON

6" Bluetooth Scan Tool with Service Functions and CAN-FD

SKU **OSB**
TPDAD800BT2 **299⁹⁹**

- FCA SGW Support
- 28+ Special Services for Your Productive Days
- Wider Coverage, Faster Solutions
- Cut the Cord, Work Without Limits
- All Systems Covered, All Issues Addressed
- Real-Time Performance Tracking with Live Data
- Effortless Organization, Ergonomic Excellence
- Identify, Record, and Share with Ease
- Take Advantage of the Feedback Feature to Communicate Any Issues You Encounter



For OSB, Call 901-300-4878

T-Ninja Pro Key Programming Via OBD2

SKU **1340225**
TPDNINJAPRO **559⁹⁹**

- Pin Reading and Key Learning
- Remote Control Learning
- Deletes Keys
- All Keys Lost
- Reads and Clears Fault Codes
- Supports Wireless and Wired Dual Connectivity

TOPDON®



Phoenix Smart Diagnostic System

SKU **1331482**
TPDPXSMART **2,259⁹⁹**

- Android Based OE-Level Coverage
- 10.1" HD Touch Screen
- TOPOLOGY Feature for Enhanced Diagnostics
- SmartLink VCI - Adds CanFD, DoIP, J2534, RP1210
- Codes/Data/Bi-Directional/Special Functions/Coding/Programming



Phoenix Max Diagnostic System

SKU **1331492**
TPDPXMAX **4,059⁹⁹**

- Includes A 4-Channel Oscilloscope
- Supports Cloud-Based Programming For 9+ Brands, Including: Mercedes-Benz, BMW, Audi, Volkswagen/Skoda/Seat, Porsche, Jaguar/Land Rover, Nissan, Subaru and Renault
- Supports 9V to 24V Vehicle Models, Configuring Both Passenger Cars and Heavy Trucks
- Heavy Duty Housing with IP65 Standards
- Auto VIN Technology Automatically Uses the Right Diagnostic Software After Identifying the Vehicle Through its VIN



UltraDiag 2-in-1 Diagnostic Scanner and Key Programmer

SKU **1368629**
TPDULTRADIAG **729⁹⁹**

- Full-System Diagnostics
- 8 Reset Functions: Oil, Throttle Adaptation, EPB, Steering Angle, DPF Regeneration, ABS Bleeding, BMS and Airbag
- Key Programming Functions: Number of Keys, PIN Reading, Key Learning, Remote Control Learning, Delete Keys and All Keys Lost



Transponder and Remote Tester Tool

SKU **OSB**
TPDT-DARTS **40⁹⁹**

- Allows Either USB or Battery Powered Function
- Supports Transponder Chips
- Supports 100+ Transponder Chips
- Includes: Quick Guide and a USB Type-C Cable



For OSB, Call 901-300-4878

Heavy Duty Non-16 Pin Cable Kit

SKU **OSB**
TPDHDCKIT **399⁹⁹**

- Includes: OBD-9, OBD-6, OBD-16, IVECO-38, IVECO-30, BENZ-14, MAN-12, MAN-37, ISUZU-3, ISUZU-20, RENAULT-12, VOLVO-8PIN, and CAT-9



For OSB, Call 901-300-4878

SHARED SERVICE FUNCTIONS

- | | | | |
|---------------------------------|---|-----------------------------|---------------------------------|
| OIL RESET | THROTTLE | AIRBAG RESET | A/C |
| EPB - ELECTRONIC PARKING BRAKE | ABS/SRS | CLUTCH | RAIN/LIGHT SENSOR |
| BMS - BATTERY MANAGEMENT SYSTEM | VGT LEARN | A/F SETTING | RESET CONTROL UNIT |
| SAS - STEERING ANGLE SENSOR | RELATIVE COMPRESSION WINDOW / DOOR / ROOF | RESOLVER SENSOR CALIBRATION | CCS/ACC VIN |
| IMMO KEYS - IMMOBILIZER & KEYS | SEATS | AUTOMATIC START/STOP | COOLANT/REFRIGERANT CHANGE |
| BRAKE BLEED | ODOMETER | ELECTRONIC WATER PUMP START | SUNROOF INITIALIZATION |
| DPF - DIESEL PARTICULATE FILTER | LANGUAGE CHANGE | EGR | TEC LEARN |
| INJECTOR SUSPENSION | HEADLAMP | FRM RESET | HV DE-ENERGIZATION/ENERGIZATION |
| | CHG TIRE SIZE | TRANSPORT MODE | ALL SYSTEM AUTO-SCAN |
| | SPEED & PTO | HV BATTERY ACC | |
| | CYLINDER | | |
| | TRANS ADAPTION | | |



MaxiCheck® MX900
 SKU #1369200 | Part #MX900



MaxiTPMS® TS900
 SKU #1337325 | Part #TS900



MaxiBAS® BT609
 SKU #1125832 | Part #BT609

	MAXICHECK MX900	MAXITPMS TS900	MAXIBAS BT609
OPERATING SYSTEM	ANDROID 11	ANDROID 11	ANDROID 9
SOFTWARE UPDATES	1 YEAR FREE	1 YEAR FREE	1 YEAR FREE
AUTOMATIC DETECTIONS	AUTO-VIN/SCANVIN	AUTO-VIN/SCANVIN	AUTO-VIN/SCANVIN
VEHICLE COVERAGE	US, ASIAN & EUROPEAN 1996+	US, ASIAN & EUROPEAN 1996+	US, ASIAN & EUROPEAN 1996+
OBDDII TEST MODES	PERFORM BI-DIRECTIONAL ACTIVE TESTS AND SPECIAL FUNCTIONS	PERFORM BI-DIRECTIONAL ACTIVE TESTS AND SPECIAL FUNCTIONS	PERFORM BI-DIRECTIONAL ACTIVE TESTS AND SPECIAL FUNCTIONS
DIAGNOSTICS & SERVICE	ALL SYSTEMS / 40+ SERVICES	ALL SYSTEMS / 40+ SERVICES	ALL SYSTEMS / 40+ SERVICES
VEHICLE CONNECTIVITY	CORDED	BLUETOOTH VCI	BLUETOOTH VCI
TPMS DIAGNOSTICS	-	INCLUDED WITH ENHANCED TPMS STATUS SCREEN	-
TPMS SENSOR COMPATIBILITY	-	AUTEL BLE SENSOR FOR TESLA + PROGRAM AUTEL MX-SENSOR 1-SENSORS	-
BATTERY TESTING	-	-	INCLUDED

CALL FOR PRICE

AUTEL®

Smoke Leak Detectors

Smoke Pro® Total Tech Smoke Machine

SKU OSB
RED95-0050 **1,189⁹⁹**

- Pinpoint Leaks as Small as 0.010"
- Rechargeable LED Inspection Light
- Field Replaceable Smoke Hose
- Refined Flow Meter Callout Heavy Duty Flow Control Valve
- Includes: Easy Intake and Easy Connect



For OSB, Call
901-300-4878

REDLINE
DETECTION.COM



Made in USA

Smoke Pro Air™

SKU 1340239
RED95-0075 **1,399⁹⁹**

- Ideal for Performing Diagnostics on the Evap Systems of Naturally-Aspirated Vehicles
- Features an Onboard Micro Air Compressor for Total Portability and Includes All Needed Accessories
- Uses OEM-Approved Fluid to Produce a Visual Vapor That is Free of Dyes and Contaminants
- Detects Leaks as Small as 0.010" and Performs Air Leak Decay Test



REDLINE
DETECTION.COM



Made in USA

ReadySmoke™ Leak Detector

SKU 744010
RED95-0400 **749⁹⁹**

- Pinpoint Intake, Exhaust and Other EVAP Leaks In Minutes
- Flow Meter Identifies Minute Leaks at and Below .010" in Diameter
- Easy Fill Dipstick Style Fluid Port
- Includes: (2) 2 Oz. OEM-Approved Vapor Producing Fluid, EVAP Service Tool Kit, Halogen Inspection Light, Cap Plug Kit, Standard Cone Adapter and Storage Case



REDLINE
DETECTION.COM



Made in USA

Intake Inflatable Block Off Bladder

OEM TOOLS®

SKU 598274
24536 **134⁹⁹**

- Conforms to Any Shape
- Intake/Exhaust: Square, Round, Oval or Rectangular
- Works with Most Automobiles and Light, Medium and Heavy Duty Trucks
- Replacement Bladder Available



Use with All
Smoke Machines

EasyConnect® Test Kit

SKU 1189091
RED96-0190 **109⁹⁹**

- Forms a Complete Seal for Effective Leak Testing without Disturbing Other Components
- Comes in a Compact and Durable Storage Case
- Compatible with Any Smoke Machine
- Includes: 4 Different Sized Adapters with 4 Add-On Components



REDLINE
DETECTION.COM



Made in USA

Smoke Machine UV Smoke Kit

SKU OSB
RED96-0303 **99⁹⁹**

- Mineral Oil Base with Integrated UV Dye
- Produces Consistent, Dense Smoke for Accurate Leak Detection
- Compatible with Redline Detection Machines

NEW

8 Oz. UV Smoke Producing Fluid

SKU OSB
RED96-0039-UV **41⁹⁹**

For OSB, Call 901-300-4878



REDLINE
DETECTION.COM



Made in USA

EasyEVAP™ Universal Filler Neck Connector

SKU 343405
RED95-0030 **124⁹⁹**

- Compatible with Any Smoke Machine and Removes Cleanly from the Gas Cap
- Essential Tool for Late Model Cars with Fuel Tank Rollover Valves



REDLINE
DETECTION.COM



Made in USA

REDLINE
DETECTION.COM

Easy INTAKE™

SKU 696477
RED95-0082 **169⁹⁹**

- Compatible with Any Smoke Machine
- Block Off Bladder Conforms to Any Shape Intake/Exhaust



Made in USA

REDLINE
DETECTION.COM

Smoke Producing Fluid (8 Oz.)

SKU 802333
RED96-0039 **21⁹⁹**

- Contains No Dye or Other Contaminants
- Works in Most EVAP Smoke Machines
- Uses OEM-Approved Fluid to Produce a Visual Vapor That is Free of Dyes and Contaminants



Made in USA

Evap Diagnostic Smoke Machine

SKU OSB
MSC43060EV **1,049⁹⁹**

- Multiple Options for Smoke Injection Include Built-In Internal Compressor, Shop Air and Inert Gases
- Pressure Decay Gauge 0-30" H2O (70 mbar)
- Flow Meter: 0 to 0.040" (0 to 1.0 mm)
- Input Pressure: Max. 100 psi (8.2 bar)
- Built-In Pressure Regulated at 0.5 psi



Mastercool®
"World Class Quality"

For OSB, Call
901-300-4878

DIAGNOSTICS

Diagnostics

Compression Tester Gauge Set

SKU 1103601
37138 **46⁹⁹**

- Use to Test Compression 0 to 300 psi on 14 mm and 18 mm Spark Plug Ports and Determine Engine Mechanical Condition

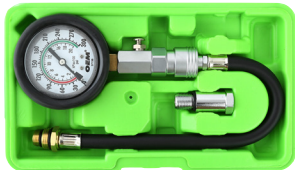

8 Piece Noid Light Set

SKU 1103589
37161 **29⁹⁹**

- Includes: GM TBI, GM SCPI, GM PFI, Ford TBI, GEO TBI, Bosch PFI, Bosch Type 2 and GM Multec 2
- See-Through Design to Check Electrical Pulses

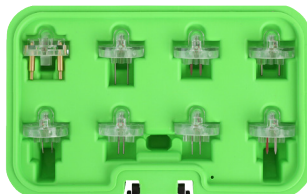

Automotive Tune-Up and Brake Bleed Kit

SKU 466495
25138 **39⁹⁹**

- Includes Components to Diagnose and Service Vacuum and Pressure-Related Systems
- Modern System Coverage – Tests Vacuum Lines, Reservoirs, Actuators, and HVAC Controls on Today's Vehicles
- Enables One-Person Brake Bleeding with Minimal Spills



Exhaust Back Pressure Tester/Gauge

SKU 1103604
37263 **84⁹⁹**

- Oxygen Sensor Adapter is M12 and M18 Thread
- 6' Hose Allows User to Test from Driver's Seat
- Test for Restricted Exhaust Systems

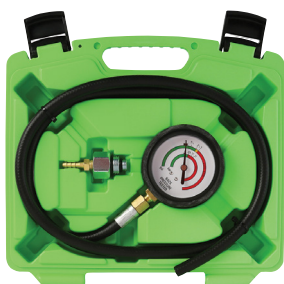

Oil Pressure Gauge Set

SKU 347229
27262 **54⁹⁹**

- For Use on Diesel and Gasoline Engines
- Includes Standard and Metric Adapters Found on Most Cars and Trucks
- 2-1/2" Easy-to-Read Gauge with Protective Boot
- Range: 0-100 psi, 0 to 7 Bar



Master Compression Test Kit

SKU 347236
27266 **174⁹⁹**

- Includes:
 - 2-1/2" Gauge with Dual Scale 0-300 psi and 0-20 Bar
 - 1-1/2" Gauge with Single Scale 0-200 psi
 - 10" Extension with Quick Connect and Protective Boot
 - M14 Hoses: Short Thread and Long Thread
 - M18 Hose with Short Threads
 - M10, M12 and M18 Solid Adapters
 - Extra O-Rings and Valve Cores



AUTEL MAXISYS ULTRA S2

ANOTHER LEAP FORWARD



6-in-1 VCMII2

MaxiSYS® MSULTRA S2
SKU #1540763 | Part #MSULTRAS2



MaxiSYS® MS919 S2
SKU #1606641 | Part #MS919S2



MaxiSYS® MS909 S2
SKU #1606642 | Part #MS909S2

Built on its award-winning predecessor, the Autel MaxiSYS Ultra, the Ultra S2 sets a new benchmark for efficiency and accuracy with upgraded hardware and advanced diagnostic features that deliver near OEM-level diagnostics and service capability.

Data-Driven Diagnostics with Enhanced PID Analysis

Data Visualization: Enhanced graphing capability to visualize multiple parameters to identify the relationship between PIDs and pinpoint system anomalies.

Live Data Fusion: Record and compare value changes across multiple systems.

Parameter Grouping: Multi-PID selection for analyzing related parameters simultaneously. Ideal for engine fault and performance and emissions troubleshooting.

Reference Sampling: Record, store, and review selected PIDs for pre- and post-repair comparison that will flag min, max, and average.

Real-Time, Split-Screen Analysis: Access the oscilloscope directly from the current Live Data screen. (MSULTRAS2 & MS919S2 ONLY)



SCAN OR VISIT
AUTEL.US/ULTRA-S2



MaxiVIDEO® MV480
SKU #1137680 | Part #MV480

- Record/Playback Images & Videos
- 4.1" Color LCD Display
- Dual Front and Side Cameras for Wider Viewing Angle

MaxiVIDEO® MV460
SKU #1089243 | Part #MV460

- 3.5" Color LCD Display

AutoLINK® AL549 | SKU #789375 | Part #AL549

- Universal OBD II and ABS Code Reader
- Read & Erase Codes, View Freeze Frame and Live Data
- Supports all 10 Modes of OBD II
- Compatible with U.S., Asian, and European vehicles, 1996 & Newer



MaxiDIAG® MD909 Pro

SKU #1597905 | Part #MD909PRO

- All Systems diagnostic tablet for U.S., Asian, and European vehicles, 1996+
- Performs 11 Common Service Tasks
- Direct-to-system access for popular service functions
- Bluetooth VCI with CanFD and DoLP support
- Read and Erase codes, view freeze frame & live data
- Quick Browser-Based Code Lookup



AutoLINK® AL329

SKU #103946 | Part #AL329

- Read/Erase Engine DTCs
- One-Touch I/M Readiness /LED Indicator
- Display Live & Freeze Frame Data



MaxiSYS® MS909CV
SKU #1174556 | Part #MS909CV

- For Class 1-8 Commercial Vehicles
- Topology Mapping on Select Models
- Engine Coverage for Construction & Agricultural Vehicles



MaxiSYS® MS906 MAX
SKU #1661671 | Part #MS906MAX5YR

- 10.1" professional diagnostics and service tablet
- Perform all-systems diagnostics
- Bi-directional Active Tests & Special Functions



MaxiCheck® MX900
SKU #1661670
Part #MX9005YR

- Read & Erase Codes
- Bidirectional Active Tests and Special Functions
- 40+ Function Service Menu



MaxiIM® IM608PROIIKPA
SKU #1336440
Part #IM608PROIIKPA

- IMMO and Key Programming Bundle
- Program IMMO & Keys for U.S., Asian, and European Vehicles
- IM608PROII Tablet, XP400Pro, Wireless JVCI, IMKPA Key Programming Adapter Kit



MaxiIM® IM508S
SKU #1442228
Part #IM508S

- Fast and Portable IMMO & Key Programming Tablet
- Includes the XP200 Key Programmer



MaxiIM® KM100
SKU #1242003
Part #KM100

- Advanced key and IMMO 5.5-in. touchscreen tablet with 2 IKEYS
- Program Autel's IKEY universal keys as smart key replacement for 3,000+ vehicles
- One-minute Key generation, Easy key button customization

CALL FOR PRICE

AUTEL®

Prices subject to change without notice. Prices do not include applicable taxes, vehicles, tires, rims, installation or optional equipment as shown. Please do not return purchases to the store. For information regarding warranty, repair, or any questions or concerns, call 901-300-4878.

LANG

TU-113PB Fuel Injection Pressure Tester

SKU 1330689 **94⁹⁹**
LNGTU-113PB

- Works on Most Domestic and Import Vehicles

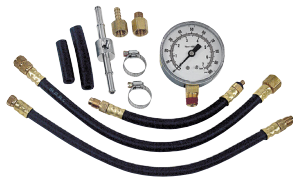

Cylinder Leakage Tester with 2 Gauges - 100 psi

SKU 1580933 **149⁹⁹**
LNGCLT-2

- 2 Gauges: 1 for Compression Reading and 1 for Shop Air
- Easy Adjustable Regulator
- Protective Boots for Gauges
- Additional Adapters Available
- Includes: Storage Case



TU-550 Master Fuel Injection Pressure Tester



SKU 1330693 **674⁹⁹**
LNGTU-550

- Covers All Domestic and Foreign Platforms 1988 to Present



Does Not Include CIS and TBI Adapters

Fuel System Cleaners



Carbon Clean 1000

SKU OSB **2,124⁹⁹**
MVC500-0220

- Complete, Through the Rail, Fuel System Decarbonizing Service
- Fuel Rail Hookup Provides the Most Effective Results
- Online Application Guide
- Unique Time Saving Adapter System
- Cleans Fuel Injectors, Combustion Chamber and Intake Valves
- Works with MV5 (400-0050) Fuel System Cleaner



MV5 Press Gas/Petrol Fuel System Cleaner 17 Oz. (6 Pk.)

SKU OSB **129⁹⁹**
MVC400-0050

For OSB, Call 901-300-4878

SUR&R®

S-Hook Sprayer

SKU 1149152 **74⁹⁹**
SURS-TOOL

- Nozzle End Produces Fine Mist Spraying Action for Thorough Cleaning of the Air Intake
- Helps Improve Fuel Performance
- Removes Carbon Build-Up
- For Use with SURFIC203

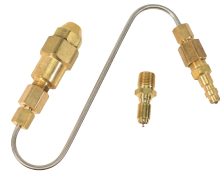

Fuel Injection Cleaner Kit

SKU 1137808 **439⁹⁹**
SURFIC203

- Makes Connections Quickly and Easily Using S.U.R.&R.'s Exclusive Quick Connects
- Holds Up to 18 Oz. of Canister Cleaning Solution
- Cleans More Thoroughly Than Aerosol Methods
- Easy to Connect and Use with Shop Air
- For Top Engine and Throttle Body Cleaning



AUTEL MAXISYS SOLUTIONS FOR EVERY SHOP



IA900LDWT FOUR-WHEEL ALIGNMENT & ADAS CALIBRATION SYSTEM

Capture the revenue after wheel alignment with required ADAS Calibration and SAS. The IA900LDWT is an industry-first, camera-based, complete diagnostics, alignment, and ADAS Calibration system with Lane Departure Warning equipment to future-proof your shop.

SKU #1337324 | Part #IA900LDWT

TIRE CLAMPS

SKU #1288490 Part #500-17

In contrast to standard clamps, tire clamps attach to tires rather than to rims, eliminating potential rim damage.



IWA500ACT INTELLIGENT WHEEL ALIGNMENT SYSTEM

Autel MaxiAlign IWA500 system is a purpose-built wheel alignment system engineered to do one thing extremely well: deliver fast, precise, and repeatable alignments. The IWA500ACT package also includes the IWA500 tablet and rim storage cabinet.

SKU #1708711
Part #IWA500ACT

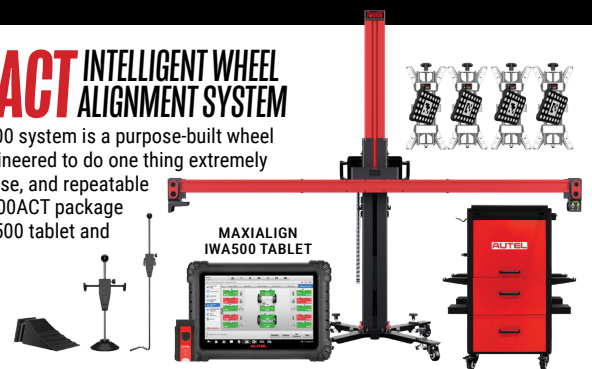

WIDE ANGLE TARGET

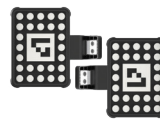

The wide angle targets attach to wheel clamps to ensure cameras can view during a max angle alignment caster sweep. Compatible with the IA900WA wheel alignment and ADAS calibration system.

SKU #1699808 | Part #500-21

HAND-HELD INCLINOMETER



The inclinometer, when paired with a MaxiSYS tablet, is used to measure tilt angles on the vehicle and provides ride height during an alignment. It is designed to aid in a four-wheel alignment of Mercedes-Benz vehicles. Compatible with the IA900WA system.

SKU #1699812 | Part #500-29

CALL FOR PRICE

AUTEL®

DIAGNOSTICS

Power Probe

Power Probe III with Case and Accessories

SKU 262523
PWPPP319FTC **229⁹⁹**

- Relay and Component Tester
- Voltmeter and Continuity Tester
- Audio Tone
- 20' Jumper Lead
- Works on 12V to 24V Sources



Power Probe III with Lead Set

SKU 1330690
PWPPP3LS01 **317⁹⁹**

- Supplies Power and Ground
- Digital Voltmeter with Min./Max. Voltage Capturing
- 4 mm Banana Jack
- 20 Ft. Power Lead



POWER PROBE

Power Probe III Master Combo Kit

SKU 1105994
PWPPPKIT03S **489⁹⁹**

- Power-Up Components
- Audible Monitoring of Electrical Signals Voltmeter
- 12V to 24V Range
- Bad Ground Indicator
- Continuity Tester
- Relay and Component Tester
- Trace Short and Open Circuits



Power Probe IV Master Kit

SKU 1330692
PWPPPKIT04 **609⁹⁹**

- Supply Power or Ground for Functional Component Testing
- Self-Resetting Thermal 8 Amp Circuit Breaker
- Multiple DC Volt Readings on the Same Display
- Quickly Determine if the Circuit is Open or is Shorted



Power Probe III Circuit Tester

SKU 1580942
PWPPP3CSRED **199⁹⁹**

- Digital Voltmeter
- Continuity Tester
- 20' Jumper Lead Set
- Relay and Component Tester
- Removable Probe Tip Adapts to Any 4 mm Lead
- 2 Bright LED Lamps
- Quickly Supply Power and Ground to the Tip



Power Probe III Professional Electrical Test Kit

SKU 1330691
PWPPPROKIT01 **389⁹⁹**

- Supplies Power and Ground for Functional Component Testing
- CAT-IV 600V Hybrid Safe AC/DC Voltmeter
- Measures Resistance to 60M Ohms
- Measures Current from .001 Amps to 10 Amps



Power Probe IV with Case and Accessories

SKU 802331
PWPPP401AS **409⁹⁹**

- Supplies Power and Ground for Functional Component Testing
- Digital Volt and Ohmmeter for Circuit Testing
- Large Color LCD Screen with Easy to Navigate User Menu
- AC-RMS, AC Peak-to-Peak, Frequency and Pulse Width for Signal Testing
- Fuel Injector Tester for Easy Circuit Diagnosis
- PCM/ECM Driver Supplies Safe Voltage for Testing Circuits



GEARWRENCH SMART DIAGNOSTICS

DIAGNOSTICS THAT BREAK ALL THE RULES

Find every fix under the hood with the new lineup of GEARWRENCH Smart Diagnostics. With bi-directional control, free software updates, and coverage for more than 180 vehicle manufacturers, there's a Diagnostic solution for everyone. Explore the app controlled and tablet diagnostic options below.

APP CONTROLLED



GEARWRENCH SCAN

EVERYDAY ENTHUSIAST DIAGNOSTIC TOOL

- 12 Key Vehicle Functions
- Full Vehicle Check
- Emissions Readiness Test
- Read/Clear OBDII Codes
- Bluetooth OBDII Connectivity
- Free Lifetime Software Updates

AutoZone SKU: 1480740

RETAIL: \$69.99

APP CONTROLLED



GEARWRENCH SMARTBT

BLUETOOTH BI-DIRECTIONAL DIAGNOSTIC TOOL

- 23 Vehicle Reset / Relearn Functions
- Full System Diagnostics
- Bi-Directional Control
- Live Data Mapping
- Bluetooth OBDII Connectivity
- Free Lifetime Software Updates

AutoZone SKU: 1480738

RETAIL: \$149.99

TABLET DIAGNOSTICS



GEARWRENCH SMART05

CORE BI-DIRECTIONAL DIAGNOSTIC TABLET

- 31 Vehicle Reset / Relearn Functions
- Full System Diagnostics
- Bi-Directional Control
- Live Data Mapping
- Wired OBDII Connectivity
- Free Lifetime Software Updates

AutoZone SKU: 1658246

RETAIL: \$399.99

TABLET DIAGNOSTICS



GEARWRENCH SMART07

PRO BI-DIRECTIONAL DIAGNOSTIC TABLET

- 38 Vehicle Reset / Relearn Functions
- Smart Topology Mapping
- Key Programming
- ECU Configuration
- High Speed Wireless OBDII Connectivity
- 3 Years of Free Software Updates

AutoZone SKU: 1480739

RETAIL: \$649.99

TABLET DIAGNOSTICS



GEARWRENCH SMART10

ALL-IN, NO-COMPROMISE BI-DIRECTIONAL DIAGNOSTIC TABLET

- 51 Vehicle Reset / Relearn Functions
- J2534 Pass-Thru Complete
- Rapid Charge Docking Station
- High Speed Wireless OBDII Connectivity
- 3-Years of Free Software Updates

AutoZone SKU: 1658251

RETAIL: \$2,249.99

GEARWRENCH® is registered as a trademark of Apex Brands, Inc., a Division of Apex Tool Group, LLC | Specifications subject to change without notice.
ATG-8337 | Apex Tool Group, LLC | 1000 Lufkin Road, Apex, NC 27539 | www.apextoolgroup.com | ©2026 Apex Tool Group, LLC

f i y www.gearwrench.com

Mityvac®

Professional Compression Test Kit

SKU 972276 **124⁹⁹**
MITMV5530

Everything You Need to Perform Cylinder Compression Tests on Motorcycles, Marine and Small Engines and an Air-Hold Adapter for Performing Valve Seal Repairs

- Adapters Include: 10 mm, 12 mm, 14 mm and 18 mm
- Extended Hoses for Hard-to-Reach Cylinders
- Large 2-3/4" Easy-to-Read Gauge
- Quick Disconnect Fittings



Silverline Elite Test Kit

SKU 988888 **144⁹⁹**
MITMV8500

- Provides Either Vacuum or Pressure with Equal Precision and Convenience
- Performs Engine Performance Diagnostics, Brake Bleeding, Fluid Transfer, Evacuation, Sampling and More
- Includes Components Needed to Perform Hundreds of Diagnostic and Mechanical Tests



TEXA

TEXA

Axone Light Car Diagnostic Kit (NANO)

SKU OSB **3,699⁹⁹**
TEXAXLTAKN

The Navigator NANO S can perform diagnostic operations on all major brands of cars and light commercial vehicles. It is the perfect entry level scan tool for automotive repair shops.

- Axone Nemo Light Rugged Tablet
- Navigator NANO S VCI
- IDC5m Car Software License
- Rugged Carrying Case with Custom Foam
- Motor TruSpeed Repair Included

More TEXA Kits Available on AZTOOL1.com or Call 901-300-4878



For OSB, Call 901-300-4878

Digital Gas Engine Compression Test Kit

SKU 383182 **234⁹⁹**
MITMV5532

- Stores Maximum Compression Value for Up to 12 Cylinders
- 3 Minute Auto Shut-Off
- Sealed, Grease and Oil-Resistant Gauge Face Prevents Contamination of Electronics
- Displays Values in psi, Bar and kPa



Diesel Digital Compression Test Kit

SKU 988885 **414⁹⁹**
MITMV5535

- Features an Electronic Tester that Memorizes Peak Values for Each Cylinder Injector Adapter
- Includes: (2) Injector Adapters and (4) Glow Plug Adapters for Testing Most Modern Diesel Cars and Light Trucks Sold in the U.S.



INNOVA®

OE-LEVEL DIAGNOSTIC TOOLS

US-BASED SUPPORT



Trusted data, powerful reporting, and pro-grade insights built to give technicians the edge in every job.

SCAN TO LEARN MORE



FREE ACCESS. NO SUBSCRIPTION REQUIRED.

- Parts/Tools for Repair
- Scheduled Maintenance
- Predicted Repairs
- Verified Fixes
- Repair Tips
- Technical Services Bulletins (TSBs)

RepairSolutionsPRO Built-in



7" TOUCH SCREEN | 44+ WORKSHOP TOOLS

RepairSolutionsPRO Built-in



5" TOUCH SCREEN | 34+ WORKSHOP TOOLS

RepairSolutionsPRO Companion App



4.3" DISPLAY | 12+ WORKSHOP TOOLS

INNOVA® AUTOMOTIVE DIGITAL MULTIMETER

3340
SKU#94874

Contact commercial sales manager for pricing.

- Tests alternators, diodes, solenoids, breaker points, wiring, switches and more
- 10 MegOhm impedance prevents damage to ECU
- Measure RPM, Dwell, Frequency, Temperature, Pulse Width, Duty Cycle
- Accessories included



INNOVA® AUDIO ENHANCED INSPECTION CAMERA

3381
SKU#1392578

Contact commercial sales manager for pricing.

- Record video and audio
- 8 Bright Illumination LEDS fully light up the inspection area
- IP67 Rated Submersible Lens allows safe inspection of areas contaminated by oil or water

Accessories Included: Magnet, Hook and Mirror

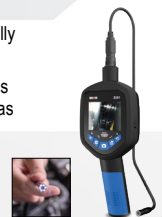

SDS-Pro

INNOVA® 7111
SKU#1062521

Contact commercial sales manager for pricing.

STORE STOCKED

- Secure Gateway (SGW) access on FCA and Nissan vehicles
- Active Tests and Special Functions
- OEM/Enhanced Diagnostics
- Removeable VCI – Wireless Diagnostics
- FREE access to RepairSolutionsPRO built-in

SDS-Tech

INNOVA® SDS50
SKU#1269649

Contact commercial sales manager for pricing.

STORE STOCKED

- OEM Diagnostics
- Active Tests and Special Functions for ECM/PCM, TCM
- Reads TPMS/Tire Pressure
- Service Check and Warning Light
- FREE access to RepairSolutionsPRO built-in

SDS-Inspector

INNOVA® SDS43
SKU#1269650

Contact commercial sales manager for pricing.

STORE STOCKED

- OEM Diagnostics
- Bidirectional, Calibration for ECM/PCM, TCM
- Workshop Tools, Service Check & Warning Light
- Multiple Report Types
- FREE access to RepairSolutionsPRO Companion App

HIGH-POWERED, RECHARGEABLE WORK LIGHTS



Portable Dual Mode LED Work Lights with Multi-Position Mounting

- Dual Mode Features a Flood LED Work Light and a Directional Flashlight
- 180° Magnetic Adjustable Base
- USB-C Rechargeable



WATER RESISTANT IPX-6



180° Multiple Positions for Angling Light

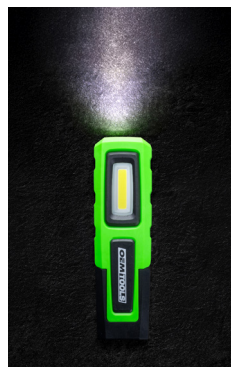

360° Hang Hook

200 Max. Lumens

SKU 1525563 **45⁹⁹**
32132

- Heavy-Duty Belt Clip
- Charging Time: 2.5 Hours

LUMENS



RUNTIMES



Magnetic Base

400 Max. Lumens

SKU 1525555 **49⁹⁹**
32124

- 360° Rotating Hanging Hook
- Charging Time: 2.5 Hours

LUMENS



RUNTIMES



Magnetic Base

600 Max. Lumens

SKU 1525559 **54⁹⁹**
32126

- 360° Rotating Hanging Hook
- Charging Time: 3.5 Hours

LUMENS



RUNTIMES



Magnetic Base

Flashlights

2 Pack Button LED Lights

SKU 1525557 **39⁹⁹**
32129

- Magnetic Base for Hands-Free Use
- Charging Time: 0.5 Hours
- Includes: Two LED Lights with Two Charging Ports, USB-C and Micro USB, and 1 Charging Cable



Magnetic Base

LUMENS

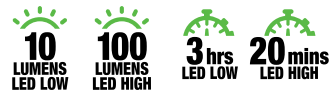

RUNTIMES

Mini Rechargeable LED Light

SKU 1525564 **22⁹⁹**
32137

- Dual Mounting Options; Heavy-Duty Clip and Dual Magnets
- Charging Time: 2.5 Hours



Heavy-Duty Clip

Magnetic Base

LUMENS



RUNTIMES

LED Light with Auto Sensor

SKU 1525569 **47⁹⁹**
32122

- Auto Sensor Automatically Turns Light Off When Sensor is Covered
- Dual Mounting Options; Heavy-Duty Clip and Dual Magnets
- Charging Time: 3.5 Hours



LUMENS

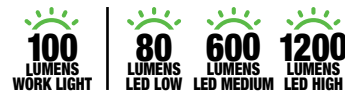

RUNTIMES



Heavy-Duty Clip

Magnetic Base



LIGHTWEIGHT
5.2 oz.



Work Lights



3-in-1 Multi-Use Rechargeable Diagnostic Under-the-Hood Work Light

SKU 591153 **152⁹⁹**
24609

- 3 Different Light Modes - White, Yellow (Smoke Detection), UV/Black (Leak Dye Detection)
- 400 Lumens of Super Bright Light Lasts More Than 5 Hours (White Light)
- Holds Charge for a Longer Run Time with 4400 mAh Li-ion Battery
- Built-In Power Bank/Source Charges Cell Phones, Tablets and Handheld Devices
- Includes Universal Micro USB Charger
- LCD Battery Indicator Screen Displays Charge Level
- Strong Magnets on Each End
- Run Time: White (5.5 Hrs.), Yellow (5.5 Hrs.), UV/Black (12.5 Hrs.)
- Accessory Kits Available

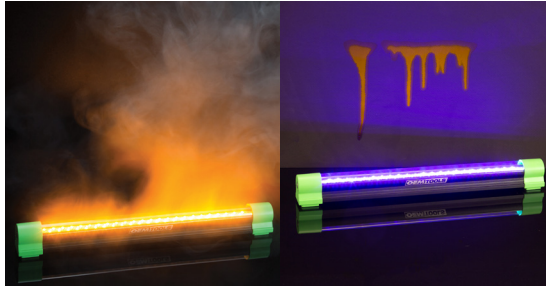

UV Leak Dye Detection Light



400 Lumens Super Bright Work Light

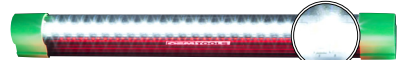

Yellow Smoke Detection Light



MAX OUTPUT
400
LUMENS

MAX RUNTIME
5.5 hrs

Multi-Application Work Lights Deliver the Versatility of Several Lights in a Single Unit

600 Max. Lumens

SKU 822266 **69⁹⁹**
25997

- 6 Hr. Runtime on High

13.4"



5 Light Modes: High, Medium, Low, Strobe, SOS

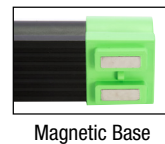

Magnetic Base

360 Max. Lumens

SKU 603726 **29⁶⁹**
24695

- 3.5 Hr. Runtime on High
- 4000 mAh Li-ion Battery

8.5"



4 Light Modes:
High, Medium,
Low, SOS

STORE STOCKED

Mechanics 500 Max. Lumen Rechargeable Flashlight and 450 Lumen Ultra Slim Wand with UV Inspection

SKU 344835 **99⁹⁹**
24607

- 5 Light Modes: 100%, 50%, 25%, Strobe and SOS
- Flashlight Head Can Be Removed and Replaced with the Slim Inspection Light (as Shown)
- 3 Powerful, UV LED Lights on Inspection Light Detect Leaks Quickly and Easily



Battery



Includes Hook



USB Rechargeable



Detachable 180° Swivel Hook

MAX OUTPUT
500
LUMENS

MAX RUNTIME
3.5 hrs

Magnetic Rechargeable LED Work Light

SKU 819644 **77⁹⁹**
25982

- 3W COB LED, Super Bright White Lights: 400 Lumens
- 3.7V 2200 mAh Li-ion Battery
- Runtime: 3 Hrs. (Work Light), 9 Hrs. (Torch Light)
- Powerful Magnets on the Back and Swivel Base
- Includes: USB Cable for Recharging

Swivels, Hangs or Sticks



MAX OUTPUT
400
LUMENS

MAX RUNTIME
9.0 hrs

Pivoting Ultra-Slim 300 Max. Lumen Work Light

SKU 603727 **27⁷¹**
24696

- Ultra-Slim Body Design Pivots 180° Providing More Light to Any Work Area
- Magnetic Base Attaches to Any Ferrous Surface
- 4 Light Modes: High, Low, Top Light and Handle Spotlight
- Top Light Illuminates the Tightest Work Areas



Handle Spot Light



Magnetic Base

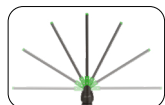

180° Swivel



3 AAA

13"

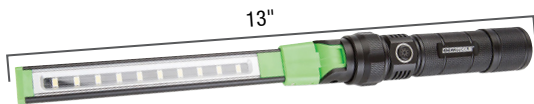

MAX OUTPUT
300
LUMENS

MAX RUNTIME
15 hrs

Rechargeable Multi-Head All-in-One Work Light Kit

SKU 765525 **137⁹⁹**
24648

- Quick-Attachment Coupler Allows for Easy Change Between 3 Interchangeable Heads

Comes with USB Charging Cord, AC Adapter, 180° Swivel Hook and (1) 18650 Rechargeable Battery

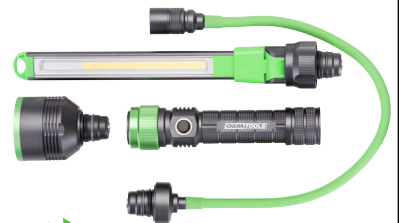

MAX OUTPUT
350
LUMENS

MAX RUNTIME
2.5 hrs



WATER RESISTANT
IP54

Work Lamp Attachment for 24648 Work Light Set

SKU 884377 **22⁹⁹**
24648E



STORE STOCKED

LIGHTING

Flashlights

Periscope LED Flashlight

SKU **OSB 25458** **14⁹⁹**

- Chip On-Board LED
- Beam Distance: 2 Meters
- Includes: Magnetic Base to Stand Upright and 2 AA Batteries

For OSB, Call 901-300-4878



OEM TOOLS



60 LUMENS



6.0 hrs MAX RUNTIME

E54 Cree 700 Lumens Tactical Flashlight

SKU 347200 **59⁹⁹**
EXPE54

- Water and Shock Resistant Aluminum Body
- No-Slip Grip Surface
- Beam Distance: 300 Meters

Requires 2 or 4 CR133A Batteries (Not Included)



700 LUMENS

3.0 hrs RUN TIME

E36 Cree Rechargeable Flashlight Kit

SKU 568461 **94⁹⁹**
EXPE36-E02

- Beam Distance: 300 Meters
- Impact Resistant Up to 1.5 Meters
- IPX-6 Water Resistant
- Includes: (1) 18650 Battery and Charger



GreatLite



1000 LUMENS
2.0 hrs RUN TIME

Stinger LED with AC/DC

SKU 291368 **260⁹⁹**
STL75732

- 425 Lumens
- Runtime: 10 Hours
- Beam Distance: 322 Meters
- Four Lighting Modes: High, Medium, Low and Strobe



STREAMLIGHT

Pocket Lights

Stylus Pro with White LED

- 48 Lumens
- Runtime: 7.5 Hours
- Waterproof Construction with an Unbreakable Polycarbonate Lens Pocket Clip

Blue SKU 291362
Red SKU 291358
STL66122 STL66120

Black SKU 291408
39⁹⁹ each
STL66118

Silver SKU 291359
STL66121



STREAMLIGHT

Cree LED Pen Light

- 3 Modes: Low (50 Lumens), High (150 Lumens) and Strobe
- 80 Meter Beam Distance
- Anodized Aluminum Body is Impact and Water Resistant
- Battery Runtime: 6 Hours (Low), 3 Hours (High)
- Comes with 2 AAA Batteries and Tactical Clip

Red SKU 592188 **29⁹⁹ each**
32838

Silver SKU 592183
32839

Black SKU 592184
32835

Green SKU 592186
32837

Blue SKU 592185
32836



GreatLite

150 LUMENS
6.0 hrs MAX RUNTIME

Headlamp



Ultra-Bright Double Strip Headlamp

SKU **OSB SLPSP81463** **51⁹⁹**

- Fast Charging USB Type C System
- Ultra Bright 3W COB LED Floodlight with 4 Brightness Settings
- High Power COB LED Beam Spot Light with 2 Brightness Settings
- Smart On/Off Motion Sensor
- Ultra Lightweight, Sleek, Slim, Low Profile Design
- Adjustable Headband with Non-Slip Grip
- IP44 Water Resistant Rating
- SOS Emergency Flash Mode



230° Wide Angle LED Beam Illuminates Entire Field of View

For OSB, Call 901-300-4878

Underhood Light

Cordless Underhood LED Work Light

SKU **OSB SPLSP81466** **209⁹⁹**

- High-Power SMD LEDs with Diffused Lens
- Brightness Control - 2 Settings
- Extends from 45.3" to 70.9" (1150 mm to 1800 mm)
- Soft Padded Hooks
- 360° Swivel and Wide 120° Light Spread

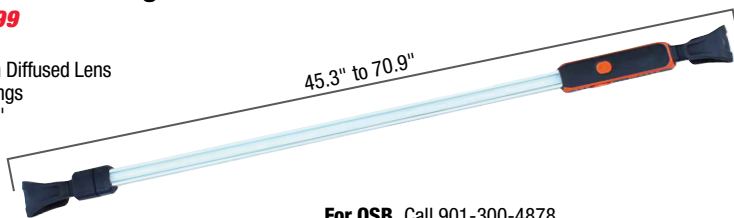

For OSB, Call 901-300-4878



Inspection Light

OEM TOOLS

700 Max. Lumen Rechargeable COB LED Slim Inspection Light

SKU 418752 **23⁹⁹**
24646

- Unique Variable Dial Lets You Control Output (0 to 700 Lumens)
- Runtime: 10 Hours (at 50% Power), 2.5 Hours (at 100% Power)
- Removable Magnetic Base with 360° Swivel and Lock Feature Lets You Adjust Angle to Point Light Where it's Needed



MAX OUTPUT
700 LUMENS
10 hrs MAX RUNTIME

Extension Cord Reel

Flexzilla Pro Extension Cord Reel

SKU **OSB LEGFZ8120603** **189⁹⁹**

- Self-Leveling System Winds the Cord Evenly
- Lighted Triple Tap Outlet for Plenty of Capacity
- Circuit Breaker Reset Button Prevents Breaker Tripping and Blown Fuses
- Oil-Resistant 12/3 AWG SJTOW Cord Flexible in Low Temperatures and Resists the Effects of Oil, Water and Sunlight
- Impact-Resistant Housing; Cord Locks Out in 2 Ft. Increments

For OSB, Call 901-300-4878



ELCOTOLCA

BATTERY SERVICE

TO ORDER, contact your Commercial Sales Manager or go to AutoZonePro.com

BATTERY SERVICE

Battery Testers

Battery Conductance Tester

MIDTRONICS Advancing Battery Management

SKU 291330 **309⁹⁹**
MIDPBT100

- Tests Both the Starter and the Charging System
- Tests 12V Automotive Batteries from 200 to 850 CCAs
- Durable Design for the Workshop or in the Field



BST360 2.0 Battery Tester

LAUNCH

SKU OSB LAU301180946 **62⁹⁹**

- Bluetooth Connectivity for Use with the Launch App and Scan Tools
- Performs Battery Health, Starting System and Charging System Testing
- Battery Types: 6V and 12V Lead-Acid, GEL and AGM
- Report Printing and Sharing

NEW



For OSB, Call 901-300-4878

100 Amp Battery Load Tester

OEM TOOLS

SKU 203583 24338 **48⁹⁹**

- Conveniently Tests Batteries in Just 10 Seconds
- Battery Load Test: 100A (12V), 50A (6V)
- Designed to Work on Both 6V and 12V Batteries Up to 1,000 CCA
- Determines State of Charge, Cranking and Charging Volts
- Convenient Handle for Transport



500 Amp Carbon Pile Load Tester

OEM TOOLS

SKU 1168827 24336 **149⁹⁹**

- Variable Load Capability to 500 Amps
- Tests Batteries to 1,000 CCA
- Test Alternators, Regulators and Starters
- Large, Easy-to-Read Gauges
- Heavy Duty Clamps



BT600 Plus Battery Tester with Printer

TOPDON

SKU OSB TPDBT600P **299⁹⁹**

- 6V/12V/24V Battery, Cranking and Charging Tests
- Onboard Power Tests Low Batteries Down to 2 Volts
- Built-In Thermal Printer for Instant Reports
- 100–2000 CCA Range with 3.5" Color Display
- Supports Multiple Battery Types: Flooded, AGM, GEL, EFB and VRLA
- Stores Up to 10 Previous Test Results
- Resistance, Sequence and Low Voltage Testing
- Measures Resistance for Lead-Acid, Lithium, Alkaline and Carbon-Zinc Batteries



For OSB, Call 901-300-4878

BT600 Battery Tester with Printer

TOPDON

SKU 1339732 TPDBT600 **135⁹⁹**

- Built-In Thermal Printer for Instant Reports
- 100–2000 CCA Range with 3.5" Color Display
- Supports Multiple Battery Types: Flooded, AGM, GEL, EFB and VRLA
- Performs Complete Battery, Cranking and Charging Tests
- Large, Reinforced, Smoke-Free and Spark-Free Copper Clamps
- Quick and Accurate Test Results



Replacement Clamps

SKU 1544657 TPDBT600RC **17⁹⁹**

Thermal Printer Paper for BT600, BT300P

SKU 1442591 TPDBTPAPER **19⁹⁹**

12V Digital Battery Electrical System Tester with Printer

ASSOCIATED

SKU 343373 ASC12-1015 **479⁹⁹**

- Tests Both Batteries Up to 1,700 CCA and Alternators
- Tests Starters and Charging Systems
- Backlit Digital Display
- 9 Languages
- Includes: Deluxe Case and Extra Print Paper



12/24V Digital Battery Electrical System Tester with Printer

SKU 1491305 ASC12-2415 **549⁹⁹**

- Tests Both Batteries Up to 2,000 CCA and Alternators

Battery Service Tools

Side Terminal Battery Wrench

- For Use with Side Terminal Batteries Found on Many GM and Other Domestic Vehicles



25282

5/16"
SKU 466513 **9⁹⁹**
25287

- Length: 5-1/2"

10 mm and 5/16"
SKU 965838 **18⁹⁹**
25282

- Length: 12"
- Double Sided



For Use on 5/16" and 10 mm Battery Terminals

2 Liter Battery Filler

SKU 972771 87010 **14⁹⁹**

- Automatic Shut-Off to Prevent Overfilling
- Fills Battery to Proper Level without Spilling



Battery Terminal Puller

OEM TOOLS

SKU 466489 25121 **14⁹⁹**

- Use to Remove Battery Terminal Clamp without Damaging the Battery Post
- Puller Will Also Work on Corroded Spring-Type Clamps

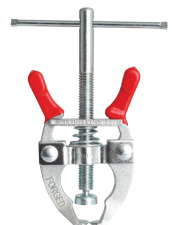

Battery Nut Pliers

SKU 943134 25123 **15⁹⁹**

- Easily Tighten and Loosen Nuts
- Offset Handles
- Serrated Jaws for a Firm Grip



Battery Carrier

SKU 094644 25283 **13⁹⁹**

- Designed to Grab, Lift and Carry Top Post and Side Terminal Batteries
- Grips Battery Widths from 5" to 7" with Rubber Pads
- Plastic Hand Grip Provides a Firm Hold



6 Piece Battery Service Kit

SKU 1168822 25110 **79⁹⁹**

- Includes: Battery Terminal Puller, 4-Way Post Cleaner, Battery Nut Pliers, Extended 5/16" and 10 mm Battery Terminal Wrench and a Side Terminal Brush Organized in a Heavy Duty, Roll-Up Storage Sleeve



Prices subject to change without notice. Prices do not include applicable taxes, vehicles, tires, rims, installation or optional equipment as shown. Please do not return purchases to the store. For information regarding warranty, repair, or any questions or concerns, call 901-300-4878.

AZG0326

35

BATTERY SERVICE

Jump Starters

Battery Tester and Jump Start

SKU 1368635 **119⁹⁹**
TPDV2200PLUS

- Jump Start Capacity: 8L Gas, 6L Diesel
- 2200A Peak Current for Jumps
- Use the App to Perform Detailed Battery Tests
- 300 Lumen LED Light with Solid, SOS and Strobe Functions
- Output Ports: Type-C: USB1, USB2, DC



TOPDON®

2-in-1 2200 Peak Amp Jump Starter and Tire Inflator

SKU 1485043 **129⁹⁹**
TPDV2200AIR

- Battery Capacity: 12,000mah
- Delivers a Powerful 2200A Peak Current with Up to 25 Starts Per Charge
- Capable of Jump-Starting Vehicles with Engines Up to 8.0 Liters for Gasoline or 6.0 Liters for Diesel
- Functions as a PD45W Fast-Charging Power Bank
- 400-Lumen LED Flashlight
- Tire Inflator Fills in Under 3 Minutes



TOPDON®

Battery Jump Starter, Power Bank and Flashlight

SKU OSB **169⁹⁹**
TPDV3000

- 3000 Peak Amps and 750A Sustained Current Allow Instant Jump-Starting for Large Engines
- Multi-Function Power Bank with Fast Charging and 12V/10A DC Output
- Advanced Safety with 10 Protection Features Including Stop Spark™ Technology
- Built for Extreme Weather and Rugged Conditions



TOPDON®

2-in-1 4500 Peak Amp Jump Starter and Battery/System Tester

SKU 1485040 **244⁹⁹**
TPDV4500PLUS

- Up to 45 Jump Starts on a Single Charge
- Test and Monitor Battery with App
- Peak Amps: 4500
- 500 Lumen Flashlight
- Outputs: Bidirectional TYPE-C, USB1, USB2
- IP65-Rated Casing
- Includes: D45W Charger Adapter, DC Adapter, DC Adapter and PD100W Cable



TOPDON®

1700 Peak Amp 12 Volt Jump Starter

SKU OSB **309⁹⁹**
SOLJNC660

- Heavy Duty Clamps with 46" #2 AWG Welding Cables
- 1700 Peak Amps; 425 Cranking Amps
- Heavy Duty Clamps with 46" Cables



SOLAR®

Premium 1700 Peak Amp 12 Volt Jump Starter

SKU OSB **324⁹⁹**
SOLJNC770R

- Heavy Duty Clamps with 68" Cables
- 1700 Peak Amps; 425 Cranking Amps
- Dual USB Outlets to Charge Mobile Devices
- Master ON/OFF Switch



SOLAR®

3400 Amp 12/24 Volt Jump Starter

SKU OSB **649⁹⁹**
SOLJNC1224

- Voltmeter Provides Charge Status of Onboard Battery
- Clore PROFORMER Battery Technology
- 3400 Peak Amps and 850 Cranking Amps - 12V
- 1700 Peak Amps and 425 Cranking Amps - 24V



SOLAR®

Kwikstart® 12 Volt Portable Power and Jump Start

SKU 850637 **264⁹⁹**
ASC6256

- Peak Amp Output: 1700 Amps
- 360 CCA of Boost Assist
- (2) 12V DC Accessory Outlets to Power and/or Recharge DC Electronics
- 32" Heavy Duty Cables and USB Port



ASSOCIATED

To Confirm Price, Availability and Ordering Instructions on OSB, Call 901-300-4878

Booster Cables

20 Ft. 4 Gauge Booster Cables with Storage Bag

SKU 1168815 **44⁹⁹**
24335

- Extra Long 20 Foot Flexible Cables Expands Your Reach
- Tangle-Free Design Ensures Quick and Easy Connections
- Insulated Clamps Fit Top and Side Post Batteries
- Oil, Gas and Acid-Resistant All Copper Wire
- Includes Storage Bag



20 Ft. Extra Flexible Cables

OEM TOOLS®

Remote Starter

Remote Starter Switch

SKU 265124 **26⁹⁹**
25330

- Heavy Clips with Insulated Sleeves Attach to Ground and Starter Solenoid Switch
- Thumb Activated Switch
- 83" Heavy Insulated Wire for Long Tool Life



OEM TOOLS®

BATTERY SERVICE

TO ORDER, contact your Commercial Sales Manager or go to AutoZonePro.com

BATTERY SERVICE

Associated Battery Chargers

ASSOCIATED



Safe In Any Weather



Made in USA



ASC6002B

ASC6021AGM

ASC6012AGM

ASCCESS6008MSK

ASCCESS6007B

ASCIBC6008MSK

	Commercial Duty Charger	Heavy Duty Fleet Charger/Analyzer	Heavy Duty Charger	Intellamatic® Charger and Reflash Power Supply			
	SKU 221248 ASC6002B	SKU 1414394 ASC6021AGM	SKU 662763 ASC6012AGM	SKU 343379 ASCCESS6008MSK	SKU 344790 ASCCESS6008 (Not Pictured)	SKU 343370 ASCCESS6007B	SKU 662745 ASCIBC6008MSK
Charger Type	Wheel	Wheel	Wheel	Wheel	Wheel	Wheel	Wheel
UL of CSA Continuous Amperage Charging Rate	100/80A	70/65/30A	70/60A	60A	60A	40A	60A
Re-Flash Power Supply Output Amperage	N/A	N/A	N/A	70A @ 13.9V	70A @ 13.9V	45A @ 13.9V	70A @ 13.9V
Crank Assist Amperage	400	205A	250	270	270	130	270
Operating Charging Voltage	6/12/18/24V	6/12/24V	6/12V	12V	12V	12V	12V
Battery Types	SLA	SLA, AGM, EFB	SLA, AGM, EFB	SLA, AGM, Gel-Cell, EFB	SLA, AGM, Gel-Cell, EFB	SLA, AGM, Gel-Cell, EFB	SLA, AGM, EFB, Li-ion, Gel-Cell
Smart Charger	N	N	N	Y	Y	Y	Y
Adjustable Charging Voltage	N	N	N	N	N	N	Y
Adjustable Re-Flash Power Supply Voltage	N	N	N	Y	Y	Y	Y
Memory Saver Mode	N	N	N	Y	N	N	Y
DC Cable Length and Gauge	8' 4AWG	6.5' 4AWG	6.5' 6AWG	6.5' 6AWG	6.5' 6AWG	6.5' 6AWG	6.5' 6AWG
Warranty*	2 Year B2B 5 Year Limited	2 Year B2B 5 Year Limited	2 Year B2B 5 Year Limited	2 Year B2B 3 Year Limited	2 Year B2B 3 Year Limited	2 Year B2B 3 Year Limited	2 Year B2B 3 Year Limited
Price	1,259⁹⁹	939⁹⁹	709⁹⁹	1,149⁹⁹	1,009⁹⁹	809⁹⁹	1,419⁹⁹

*Two years bumper to bumper (B2B) manufacturer's warranty with five years transformer/rectifier for heavy duty battery chargers (6001A, 6002B, 6006, 6009 and 6012) and three years transformer/rectifier warranty for INTELLAMATIC wheeled smart chargers.

Power Supply

ASSOCIATED

12V - 90A Reflash Power Supply and Charger

SKU OSB
ASCCESS6100 **1,669⁹⁹**

- Adjustable Power Supply from 12.6V to 14.9V at Up to 90 Amps
- Safe for All Batteries Including AGM, EFB, Li-ion and Gel
- OEM Vehicle Manufacture Approved
- 8.4 Ft. DC Leads

For OSB, Call 901-300-4878



120A Power Supply and Battery Charger

SKU 1485033
TPDT1200005 **899⁹⁹**

- Intelligent Current (5-120A) and Voltage (11-16.8V) Output Adjustment
- 3 Major Charging Modes and 9-Step Smart Charging
- Compatible with Lead-Acid Batteries and Lithium Batteries
- Clamp Cable Length: 16 Ft.



TOPDON®

Prices subject to change without notice. Prices do not include applicable taxes, vehicles, tires, rims, installation or optional equipment as shown. Please do not return purchases to the store. For information regarding warranty, repair, or any questions or concerns, call 901-300-4878.

BATTERY SERVICE

Wheeled Chargers



Battery Charger 12V

SKU 479179 **299⁹⁹**
SOL4735

- EZ View Control Panel
- 200 Amp Engine Starting Assistance
- 40 Amp Fast Charge Rate
- 5 Amp Setting for ATVs, Boats, Lawn and Garden Applications

Battery Charger with Engine Start 12/24V

SKU OSB **389⁹⁹**
SOL4745

- 40 Amp 12V, 20 Amp 24V Charge Rate



For OSB, Call 901-300-4878

SOL4735

6/12V, 40A Standard **ASSOCIATED**

Duty Wheel Charger

SKU 344795 **449⁹⁹**
ASCUS20



- 40 Amp Charger with 90 Minute Timer
- 40 Amp Continuous Rating at 6/12 Volts
- 200 Amp Cranking Assist and 330 Amps Boost
- Fan Cooling Prevents Overheating
- UL Listed
- Two Year Manufacturer's Warranty



BONUS VALUE: \$44.99



20 Ft. 4 Gauge Booster Cables with Storage Bag

24335

With Purchase of: ASCUS20

Offers Good Through September 30, 2026



Bench Chargers

6/12V, 1A Maintainer

SKU 765478 **69⁹⁹**
ASC9003A

- LED Lights Indicating Charging Status
- Includes 2 Sets of Charging Leads
- OEM Vehicle Manufacture Approved
- Safe for AGM, Gel Cell, SLA Batteries
- Reverse Polarity Protected
- Overcharge Protection
- 1 Year Warranty



ASSOCIATED

6/12V, 15/2A Smart Bench Top Charger

SKU 850634 **199⁹⁹**
ASC3100A

- Digital Display Shows Charging Voltage/Amperage or Time Remaining
- Safe for AGM, Gel Cell, SLA Batteries
- 100A Boost
- 1 Year Warranty



Smart Charger

30A Smart Charger and Power Supply

SKU 1442582 **319⁹⁹**
TPDT30000

- Suitable for Multiple Battery Types, Including AGM, LI, WET, GEL, MF CAL and EFB
- 9-Step Smart Charging, Checks for Sulphation and Acid Stratification, Repairs Batteries, Prevents Battery Damage
- Works as a Stable Power Supply for 12V and 24V Devices
- Current Range: 12V-30A, 24V-15A, 6V-15A, 12V-10A
- Clamp Cable Length and Gauge: 7.2', AWG10



One Charger Does It All

AUTEL MAXIBAS BOOST REVENUE AND CUSTOMER SATISFACTION

UNRIVALED ALL-IN-ONE TOOL FOR TESTING AND ADVANCED BMS FUNCTIONALITIES, INCLUDING BMS RESET AND REGISTRATION.



GAIN BATTERY SERVICE VISIBILITY ACROSS YOUR NETWORK

ADVANCED BMS FUNCTIONS & ALL-SYSTEM DIAGNOSTICS

- Largest Vehicle Coverage in the Category
- Battery & Electrical System Resets
- One-touch Battery Registration
- Print, Email, or Text Battery and Health Reports to Customer
- 12 and 48 Volt Lithium Ion Capabilities for Mild Hybrid Vehicle Applications
- Read and Clear Codes

ADVANCED BATTERY DIAGNOSTICS & SERVICE

- Adaptive Conductance Technology Reduces Battery Misdiagnosis
- Eliminate Charge and Retests On Discharged Batteries
- Automatic Vehicle ID with AutoVIN, VINscan, and Plate Scan
- Quickly Diagnose Low-capacity Batteries
- Battery Location Diagrams and Guided Replacement Instructions

MaxiBAS® BT506

SKU #1125835 | Part #BT506

- Use with Smartphone or other Smart Device
- Connects with all Autel Bluetooth capable Professional Tools
- Support In-vehicle and Out-of-Vehicle Testing of Passenger Vehicle Batteries
- Test 6- and 12-volt Batteries: 100 - 2000 CCA
- Test 12- and 24- Cranking/Charging Systems
- Test Flooded, AGM, AGM Spiral, EFB & GEL Batteries



OBDII EXTENSION CABLE

SKU #1443473 | Part #VCIEXTCAB

- Compatible with all OBDII-compliant VCIs
- It keeps VCI in sight and is easy to retrieve and not forget after use



MaxiBAS® BTAK

SKU #1149588 | Part #BTAK

- Battery Tester Accessory Kit
- Digital Multimeter and Current Clamp Kit
- Measures Voltage, Current and Resistance



MaxiBAS® BTMS

SKU #1149587 | Part #BTMS

- Battery Tester Memory Saver
- Preserves Vehicle Codes and Electronic Presets When Replacing Battery
- Enables Vehicle Computer to Be Powered and Maintain Data When Connected to Backup Vehicle Battery



CALL FOR PRICE

AUTEL®

GREASE GUNS

TO ORDER, contact your Commercial Sales Manager or go to AutoZonePro.com

GREASE GUNS

Grease Guns

- Cast Iron Pump Head for Added Strength and Durability
- Multiple Filling Options to Support Suction, Filler and Cartridge Loading

- Precision Fit Plunger Prevents Grease Bypass and Resists Scoring
- Heavy Duty Follower Spring Allows Easy Priming and Efficient Pumping

OEM TOOLS



87206

Mini Lever Action



87204

Lever Action Clear

Clear Barrel for Easy Grease Monitoring



87201

Lever Action



87203

Pistol Grip with 18" Extension Hose



87205

Pneumatic with 18" Extension Hose

SKU 1207896 87206	SKU 1207899 87204	SKU 1362012 87201	SKU 1207888 87203	SKU 1207901 87205
• 4,000 Max. psi	• Includes 7" Extension • 10,000 Max. psi	• Includes: 6" Steel Extension • 7,000 Max. psi	• Pistol Grip Handles Supports One Handed Operation • 6,000 Max. psi	• Includes 5.5" Extension • Air Operated for Continuous Lubrication Flow • 6,000 Max. psi
23⁹⁹	54⁹⁹	39⁹⁹	46⁹⁹	69⁹⁹

Grease Gun Accessories

7 Piece Grease Gun Accessory Kit

SKU 978118 **74⁹⁹**
25711

- Includes: Press-On 90° Lube Tool, Straight Extension, 300 mm Hose Extension, Slide-On 90° Coupler, Rubber Tip Nozzle, Needle Nozzle and 60° Coupler



Extension Hoses with Spring Guard

- Premium Grease Hoses for Manual and Air-Operated Grease Guns
- Spring Guard for Added Rigidity to Prevent Kinking
- Max. Working Pressure: 4,500 psi
- Burst Pressure: 12,000 psi
- Accessory Thread: 1/8" NPT



12"

SKU 1207902 **11⁹⁹**
87220

18"

SKU 1207887 **14⁹⁹**
87221

36"

SKU 1207893 **18⁹⁹**
87222

70 Piece Grease Fitting Assortment

SKU OSB 25752

28⁹⁹

- 70 Assorted Grease Fittings in 6 Popular Sizes



For OSB, Call 901-300-4878

Bearing Packer

SKU OSB 26540 **25⁹⁹**

- Quickly Flushes Out Old Grease and Repacks Bearings with New Grease
- Transparent, Impact Resistant Cup Allows User to Clearly See Grease Level
- Works on Bearings with Up to 3-1/2" Outside Diameter



For OSB, Call 901-300-4878

Universal Bearing Packer

SKU 1339731 **9⁹⁹**
25081

- Connects to Any Grease Gun
- Services Most Roller and Ball Bearings
- Forces Out the Old Grease and Evenly Injects Fresh Grease



Lincoln

20V Li-ion PowerLuber Kit

SKU 751676 **549⁹⁹**
LIN1884

- Delivers Grease at Up to 10,000 psi
- Built-In LED Illuminates the Work Area
- Includes: Grease Gun, 2 Batteries, Charger and Case
- 36" Flex Hose



12V Li-ion PowerLuber Kit

SKU 605324 **433⁹⁹**
LIN1264

- Li-ion Battery for Maximum Power and Efficiency
- Delivery at Up to 8,000 psi
- Built-In LED Illuminates Dimly Lit Areas
- 30" Grease Hose



Fully Automatic Pneumatic Grease Gun

SKU 445386 **179⁹⁹**
LIN1162

- Fully Automatic, Continuous Operation
- 30" High-Pressure Hose with Coupler and Attachment Clip
- Pump Ratio: 40:1 at 150 psi
- Max. Grease Pressure: 6,000 psi



Super Pistol Grip

SKU 445385 **89⁹⁹**
LIN1134

- 18" Whip Hose
- Includes Rigid Pipe
- Variable Stroke Design
- 7,500 psi
- Filler Nipple/ Bleeder Valve



Professional Lever Grease Gun with 18" Whip Hose and Coupler

SKU 522903 **54⁹⁹**
LIN1147

- 3-Way Loading: By Cartridge, Bulk Load and Suction Load



Prices subject to change without notice. Prices do not include applicable taxes, vehicles, tires, rims, installation or optional equipment as shown. Please do not return purchases to the store. For information regarding warranty, repair, or any questions or concerns, call 901-300-4878.

AZG0326

OIL CHANGE

Oil Drains

LINCOLN

18 Gallon Rolling Oil Drain

SKU 988882 **399⁹⁹**
LIN3601

- All Steel Design Includes Reinforced Caster Supports
- 14" Telescoping Bowl: Range of 45" to 72"
- Preset Air Regulator (Up to 150 psi)
- Pressurized Self-Evacuation Feature Requires Only Shop Air and a Tire Chuck to Discharge Fluids



25 Gallon Used Fluid Combo Drain/Evacuator

SKU 543345 **899⁹⁹**
LIN3639

- Powerful Compressed Air Operated Venturi Vacuum Quickly Draws Fluids from Reservoirs
- Includes: Mercedes-Benz, BMW and VW Dipstick Tube Adapters and 6 Evacuation Wands of Varying Flexibility, Diameter and Length
- Pressurized Self-Evacuation Feature Requires Only Shop Air and a Tire Chuck to Discharge Fluids
- Min. Height: 60"
- Max. Height: 74"



25 Gallon Used Fluid Evacuator

SKU 543344 **659⁹⁹**
LIN3637

25 Gallon Used Fluid Gravity Drain

SKU 543350 **779⁹⁹**
LIN3635

OEM TOOLS

18 Gallon Rolling Oil Drain

SKU 667005 **249⁹⁹**
87042

- Self-Evacuating Design Operates Using Standard Shop Air Connections
- Funnel Capacity: 2.6 Gallons
- Funnel Diameter: 17"
- Min. Height: 44.5"
- Max. Height: 68.5"



21 Gallon Oil Drain Vacuum and Extractor

SKU 546658 **799⁹⁹**
24862

- Designed for the Collection of Used Fluids from Lift Mounted Vehicles or by Evacuation Directly from Fluid Reservoirs or Dipstick Tubes
- Funnel Diameter: 15"
- Funnel Extension Adapter: 22"
- Funnel Height Adjustment: 45" to 62"
- Includes 5 Extraction Tubes: 7 mm x 35", 6 mm x 29", 6 mm x 23", 6 mm x 22" and 3/8" x 15"



18 Gallon Rolling Oil Drain

SKU 606546 **329⁹⁹**
LIN3518

- Durable, High-Density Polyethylene Reservoir with Flat-Top Design to Hold Drain Filters, Tools, Nuts, Bolts, etc.
- Funnel Incorporates Splash Shield to Catch Overspray
- Optional Cam Lock Evacuation Kit



Drain Adjusts from 40" to 77"



Flat-Top Design to Hold Tools, etc.

LINCOLN

Upright Portable Oil Drain

- Features Built-In Drain Valve and Evacuation Spout
- 4 Heavy Duty Casters for Easy Transport
- Includes: Tool Holder

9 Gallon

SKU 908386 **169⁹⁹**
87032

- Adjustable Drain Height: 32" to 62"
- Funnel Diameter: 17"



OEM TOOLS

21 Gallon Waste Oil Drain

SKU 544817 **599⁹⁹**
24861

- Pressurized Self-Evacuation Feature Requires Only Shop Air
- Large Diameter Funnel Includes a Removable Filter Screen and Wide-Mouth Extension
- Funnel Diameter: 15"
- Funnel Extension Diameter: 22"
- Funnel Height Adjustment: 45" to 62"



Large Funnel



Sight Tube Catches Fluids without Spills

OEM TOOLS



Accessories

Prevents Splashing of Hot Oil

SHARK
USA

Oil Drain Splash Pads

- Keep Work Areas Clean While Changing Transmission or Other Oils
- Allow Hot Oil to Drain Through Porous Pad

15" Round

SKU 1340218
SHA73850

19⁹⁹



22" Square

SKU 1340219
SHA73851

27⁹⁹



Drains Not Included. Not for Coolants or Fluids That Will Be Recycled in the Vehicle

Super Transmission Drain Funnel

SKU 291377 **99⁹⁹**
LIS17902

- Extends the Catch Area of Any Lift Drain
- Fits the Ford E 40D
- Dimensions: 24" x 36"

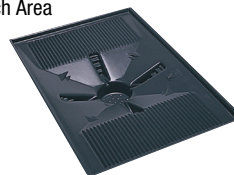

Lisle

Transmission Drain Pan

SKU 908383 **39⁹⁹**
87035

- Flexible Plastic Construction Fits on Top of Funnels for Most Lift Drains
- Built-In Screen to Catch Debris, Parts and Tools
- Dimensions: 22-3/4" L x 23-3/4" W x 4-3/4" H



OEM TOOLS

Oil Filter Tools

Filter Removal Cup

- Specifications: 6" x 6" x 6" (34 Oz. or 1 Liter), Volume Sufficient to Hold Typical Size Filters Commonly Used on Cars, SUVs, Light Duty Trucks and Vans
- Safely Holds Oils, Fuel (Gasoline, Diesel, Biofuels), Brake Fluid, Antifreeze and Other Hazardous Fluids. (Not Intended for Storing Fluids)

For OSB, Call 901-300-4878



1 Pack
SKU 1089033
SURFC5
29⁹⁹

2 Pack
SKU OSB
SURFC5PK2

39⁹⁹
REG. \$59.98
SAVE OVER \$19

When You Buy the 2 Pack



Torque Limiting Adapter for Oil Filter Canister Caps

SKU 1580932 **29⁹⁹**
87118

- 3/8" Drive Adapter Limits Torque to 25 Nm (18 Ft. Lb.)
- Prevents Over Tightening and Damage to Plastic and Metal Oil Filter Caps
- Can Also Be Used with a 21 mm Socket or Wrench for Limited Access Areas



Swivel Oil Filter Wrench

SKU 1125870 **9⁹⁹**
87115 REG. \$14.99

- Fits Oil Filters 4-3/4" to 5-3/4"
- 1" Wide Stainless Steel Band

SAVE \$5



Offer Good While Supplies Last Through September 30, 2026



Auto Fit Filter Pliers

SKU 1339727 **16⁹⁹**
87164

- Suitable for Filters with 2.4" to 5" Diameters
- Long Reach Slip Joint Design
- Precision Machined Jaw
- Non-Slip Comfort Grip



Wide Range Filter Wrench

SKU OSB **14⁹⁹**
87162

- Fits Standard Sizes from 3-1/8" to 3-7/8"
- Designed for an Exact Fit to Prevent Slipping
- Use with a 3/8" Drive



For OSB, Call 901-300-4878

3 Jaw Adjustable Filter Wrench

SKU 1339734 **14⁹⁹**
87160

- Works on a Variety of Vehicles
- Fits Oil Filters 2-1/2" to 4-1/2" (63.5 mm to 114 mm)
- Fits 3/8" Drive Ratchets and Extensions
- Perfect for Removing Hard to Reach Filters



3 Jaw Adjustable Magnetic Oil Filter Wrench

SKU 908387 **14⁹⁹**
25101

- Oil Filter Diameter: 2.4" to 3.6" (60 mm to 93 mm)
- Secure Magnetic Attachment
- Spring-Loaded Legs for a Secure Grip
- Includes 3/8" to 1/2" Drive Adapter



4 Piece Swivel Oil Filter Wrench Set

SKU 1414418 **29⁹⁹**
87117

- Fits Oil Filters 2-3/8" to 2-7/8", 2-7/8" to 3-3/8", 3-3/8" to 3-3/4" and 3-3/4" to 4-3/8"
- Dimpled Band with 3 Sets of Grippers to Hold Filter Securely in Place
- 1" Wide Stainless Steel Band for a Strong Grip and Slip Resistance
- Rubber Cushioned TPR Grip for Comfort and Safety in Tight Places
- Includes OEMTOOLS 87111, 87112, 87113 and 87114



4-in-1 Steel Oil Filter Wrench

SKU 1189097 **9⁹⁹**
87116

- 4 Interchangeable Swivel Bands
- Size Range 2-3/8" to 4-3/8" (60.3 mm to 111.1 mm)
- 1 Swivel Handle with 4 Stainless Steel Bands
- Bands are Easily Removed and Installed



2-3/8" to 5" Oil Filter Pliers

SKU 757057 **29⁹⁹**
25324

- Removes Stubborn Oil Filters from Gas or Diesel Engines
- Long Reach Slip Joint Design
- Precision-Machined Jaw
- Non-Slip Comfort Grip
- 14" Length



2-1/2" to 4-5/8" Oil Filter Pliers

SKU 548380 **14⁹⁹**
25320

- 20° Jaw Bend for More Applications
- Jaw Teeth for Sure Grip
- 12" Length



Heavy Duty Oil Filter Strap Wrench

SKU 1544663 **22⁹⁹**
87119

- For Use with 3/8" or 1/2" Drive Tools
- Fits Oil Filters Over 8" in Diameter
- Heavy Duty 27" Nylon Strap



15" Chain Wrench

SKU 452624 **54⁹⁹**
22659

- Great for Stubborn Oil Filters
- Designed for Tight Spaces
- Double-Action Allows Use in Either Direction
- Capacity: 5-1/2" Diameter
- 15" I-Beam Handle



Heavy Duty Truck Oil Filters

- Extra Wide Band for Secure Grip
- 1/2" Drive



SKU	Part #	Range	Price
344322	25231	4-1/8" to 4-5/8" (104 to 118 mm)	34.99
344323	25232	4-5/8" to 5-1/4" (118 to 134 mm)	34.99
344324	25233	5-1/4" to 5-3/4" (134 to 142 mm)	39.99



Oil Filter Plug for Cummins

SKU 1340221 **8⁹⁹**
87168

- Perfect Tool for Installing and Removing Oil Filters
- Compatible with Dodge 6.7 Diesel Engines
- Prevents Oil Leaks When Removing Oil Filters from Engines
- Hard Plastic Construction for Maximum Strength and Durability
- Wide U-Shaped Handle for Added Grip and Control



OIL CHANGE

Cap Style Filter Wrenches

Toyota/Lexus Oil Filter Cap Wrench Set

SKU 383457 **37⁹⁹**
25409

- Sizes: 64 mm, 73 mm and 74 mm
- Comes in Sturdy Blow Mold Case



9 Piece Oil Filter Cap Wrench Set

SKU 255627 **159⁹⁹**
27199

- Includes: 5 Chrome Plated Aluminum Wrenches (64.5 mm - 14 Flute Toyota, 64.5 mm - 14 Flute Toyota/Lexus, 88.8 mm - 15 Flute Hyundai/Kia, 74.2 mm - 14 Flute European, 86.6 mm - 6 Flute European), (1) 63 mm to 83 mm Adjustable Filter Wrench for Universal Applications, 3 Forged Low Profile Oil Filter Sockets (27 mm, 32 mm and 36 mm) and 3/8" Drive Application Chart for Quick Reference
- Comes in Sturdy Blow Mold Case



10 Piece Metric Cap Wrench Set

SKU 1189096 **39⁹⁹**
87151

- Painted for Rust Resistance
- Includes: 65/67 mm - 14 Flutes, 80 mm - 15 Flutes, 68 mm - 14 Flutes, 86 mm - 16 Flutes, 74/76 mm - 15 Flutes, 93 mm - 15 Flutes, 76 mm - 14 Flutes, 93 mm - 36 Flutes, 76 mm - 30 Flutes, 100 mm - 15 Flutes
- Comes in Sturdy, Green Blow Mold Case



Make	SKU	Part #	Size	Price	
BMW/Volvo	255675	25453	86.6 mm - 16 Flutes	19.99	
Chrysler	1340234	87134	84 mm - 14 Flutes	19.99	
Hyundai/Kia	255659	25454	88.8 mm - 15 Flutes	23.99	
Land Rover	1340238	87137	90 mm - 15 Flutes	17.99	
Mazda/Ford	1340228	87133	75.6 mm - 14 Flutes	10.99	
Mercedes-Benz, Sprinter, VW, Audi, Porsche, Mazda	1340230	87132	74.2 mm - 14 Flutes	9.99	
Toyota/Lexus	OSB	25412	64 mm - 14 Flutes	13.99	
Toyota/Lexus	255634	25451	64.5 mm - 14 Flutes	16.99	
Toyota/Lexus	1340227	87131	64.5 mm - 14 Flutes	13.99	
Volvo	1340237	87136	88.8 mm - 15 Flutes	18.99	

For OSB, Call 901-300-4878

Drain Plug Tools

14 Piece Drain Plug Socket Set

SKU 818568 **43⁹⁹**
25374

- Designed for Both Foreign and Domestic Vehicles Including: BMW, Ford, Mazda, Mercedes-Benz, Nissan, Peugeot, Renault and More
- Ideal for Removal of Oil Drain Plugs from Manual Transmissions, Transfer Cases, Differential Housings and More
- Includes Hex: 9, 10, 12, 14 and 17 mm; Square: 7, 8, 11, 13 mm, 5/16", 3/8"; Female Square: 10 mm; Male Triangle: 10 mm; Tamper-Proof Triple Square: 16 mm



8-in-1 Swivel Wrench - Metric

SKU OSB **24⁹⁹**
47200

- Metric: 12, 13, 14, 15, 16, 17, 18 and 19 mm
- Designed to Fit Most Oil Drains, Transfer Case and Differential Plugs
- Features Offset Head Design with Yoke Support for High Torque Applications

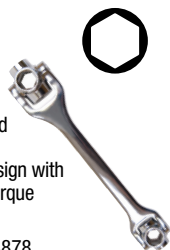

For OSB, Call 901-300-4878

8-in-1 Oil and Lube Multi-Wrench

SKU 1442585 **59⁹⁹**
CTA2497K

- Male Square and Hex
- Square: 8 mm, 10 mm, 3/8" and 1/2"
- Hex: 10, 12, 14 and 17 mm
- Designed to Fit Most Oil Drains, Transfer Case and Differential Plugs
- Features Offset Head Design with Yoke Support for High Torque Applications



3 Piece Plastic Oil Drain Plug Removal Set

SKU 1207894 **11⁹⁹**
25098

- Safely and Easily Removes Plastic Oil Drain Plugs on Late Model Ford, Volkswagen, BMW and Audi Cars
- 3/8" Drive
- Does Not Cause Damage to the Plug



Plastic Oil Drain Plug Removal Set

SKU OSB **69⁹⁹**
SURDPR350

- Releases Late Model Plastic Oil Pan Drain Plugs without Damage for Audi/BMW/Ford/Lincoln/VW



For OSB, Call 901-300-4878

Oil Filter Sockets

7 Piece Oil Filter Removal Socket Set

SKU 191682 **41⁹⁹**
27197

- 3/8" Drive
- Includes: 24 mm for Cadillac; 27 and 36 mm for Mercedes-Benz, VW, Cadillac, Buick, Saturn, SAAB; 29 mm for Dodge Cummins Fuel Filter; 30 mm for Korean Cars; 32 mm for GM, Saturn and SAAB; 35/36 mm for Ford Diesel, MINI, BMW and Mack; 38 mm for Vauxhall Vectra
- Comes in Sturdy, Green Blow Mold Case

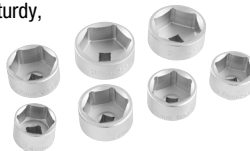

7 Piece Offset Oil Filter Cap Wrench Set

SKU 1145990 **27⁹⁹**
87165

- 3/8" Drive Set Includes: 24 mm for Cadillac; 27 and 36 mm for Mercedes-Benz, VW, Cadillac, Buick, Saturn, Saab; 29 mm for Dodge Cummins Fuel Filter; 30 mm for Korean Cars; 32 mm for GM, Saturn and SAAB; 35/36 mm for Ford Diesel, MINI, BMW and Mack; 38 mm for Vauxhall Vectra
- Comes in Sturdy, Green Blow Mold Case



3/8" Drive

- Use with a 3/8" Drive Chrome Plated

27 mm Socket

SKU OSB **10⁹⁹**
87171



32 mm Socket

SKU OSB **11⁹⁹**
87173

36 mm Socket

SKU OSB **16⁹⁹**
87174

For OSB, Call 901-300-4878

3 Piece Low Profile Oil Filter Socket Set

SKU 094803 **18⁹⁹**
27204

- Includes: 27, 32 and 36 mm
- 3/8" Drive



36 mm Oil Filter Socket for 6.0L Ford Diesel

SKU 110279 **9⁹⁹**
25411



Prices subject to change without notice. Prices do not include applicable taxes, vehicles, tires, rims, installation or optional equipment as shown. Please do not return purchases to the store. For information regarding warranty, repair, or any questions or concerns, call 901-300-4878.

No Spill Oil Funnels

Universal No-Spill Oil Funnel Set

SKU 1533126 **15⁴⁹**
87025

- Mounts Directly to Vehicle's Oil Fill Port for Spill-Free Oil Changes
- Includes 12 Adapters and 2 Extensions to Cover Most Engine Types
- No-Spill Adapters are Threaded to Securely Fit Filler Necks and Eliminate Oil Spills
- Funnel Can Support an Inverted Quart of Oil
- Transparent Funnel with Embossed Scale Lets You Easily Monitor Fluid Levels



STORE STOCKED

Universal Direct Fit No Spill Oil Funnel Set

SKU 824884
87039

- Set Includes: Universal Oil Funnel, Chrysler (87019), Ford/Mazda (87020), GM (87021), Honda (87022), Toyota/Lexus (87024), Subaru Adapter, Toyota/Lexus Adapter and 150° Extended Adapter (87027) and Storage Rack
- Funnel Screws Directly into Filler Neck
- Threaded to Fit a Range of Import and Domestic Vehicles Older and Current Models
- Transparent Lower Chamber to Monitor Oil Flow
- Wide Passage for Rapid Refilling



Includes Wall Mount Bracket and Drip Tray



OEM TOOLS

99⁹⁹

REG. \$143.95

SAVE OVER \$43

When You Buy the Set

Fast-Clamp Universal Oil Funnel

SKU 825017 **45⁹⁹**
87037

- Automatically Adjusts to Filler Neck
- Securely Clamps into Filler Neck; No Need to Hold Funnel in Place During the Refilling Process
- Transparent Lower Chamber to Monitor Oil Flow
- Clamp Can Be Used with Standard Funnels



Direct Fit Individual Funnels



SKU	Part #	Description	Price
824892	87019	Chrysler, Dodge and Jeep	27.99
824879	87021	GM and BMW	27.99
824890	87022	Honda	29.99
824888	87023	Subaru	29.99
824886	87024	Toyota, Lexus, VW and Mercedes	29.99

Dispensers

8 Quart Dispenser Lid and Cap

SKU 080078 **34⁹⁹**
LIS19702

- Spout Cap and Lid to Keep Out Contaminants
- Many Large SUVs and Trucks Now Require More Oil



Lisle

10 Quart Oil Jug

SKU 605325 **46⁹⁹**
87018

- Safe for Automotive Oils and Fluids
- Convenient Carry and Pour Handles
- Spill Proof Caps

OEM TOOLS



Oil Funnels

Vortex Funnels™

- Innovative Vortex Design Vents Air as You Pour, to Increase Flow Speed for Fast, Clean, Consistent Pouring
- Integrated Back Splash and Bottle Support Provide Cleaner Pours with Fewer Spills
- Triangular Body Fits Tight in Round Fill Ports to Minimize Tipping During Use



Short Vortex Funnel™

SKU OSB 87307 **2⁹⁹**

- Compact 5.8" Height with 4" Opening and 175 mL C
- Size: 5"D x 4"W x 5.8"H
- Spout Width: 1.15"



For OSB, Call 901-300-4878

Slim Vortex Funnel™

SKU OSB 87308 **3⁴⁹**

- Slim 3" Width and 11" Height slip into the Tightest Fill Necks, with a 125 mL Chamber for Precise, Low-Volume Pours
- Dimensions: 3.8"D x 2.9"W x 11.2"H



Drain Pans

16 Quart Oil Drain Pan - Green

SKU 908389 **34⁹⁹**
87034

- Heavy Duty Polyethylene Construction
- Features a Pour Spout and No-Splash Lip

Green

SKU 908389
87034

34⁹⁹

16 Quart Oil Drain Pan - Black

SKU 908382 **34⁹⁹**
87033

- Heavy Duty Polyethylene Construction
- Features a Pour Spout and No-Splash Lip

OEM TOOLS



2.8 Quart Low-Profile Oil Drain Pan

SKU 568474 **16⁹⁹**
87017

- Built-In Level Scale Lets You See Fluid Level



Great for Motorcycles and Small Engines

4.7 Quart Clear Oil Drain Pan

SKU 568469 **12⁹⁹**
87013

- Built-In Level Scale Lets You See Fluid Level



Great for Transmission Fluid Changes

11-Quart Drain Pan - Black

SKU OSB 87312 **9⁹⁹**

- Built-In Level Scale Lets You See Fluid Level



NEW

20-Quart Drain Pan - Green

SKU OSB 87321 **12⁹⁹**

- Built-In Level Scale Lets You See Fluid Level



NEW

For OSB, Call 901-300-4878

Oil and Transmission Funnel

SKU 547009 **16⁹⁹**
87008

- Both Straight and 45° Angle Screen to Prevent Debris from Entering Transmission
- Includes: Screen and Dust Cap
- Length: 25"

OEM TOOLS

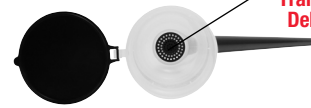

Filter to Keep Transmission Debris Free



Offset Funnel with Spout Cap and Lid

SKU 1544662 **21⁹⁹**
LIS18232

- 10" Tall Translucent Funnel with a 6-3/4" Offset from Center of Mouth to Center of Spout
- Lid and Spout Cap Help Keep Funnel Contaminant Free
- Includes: Offset Funnel with Cap and Lid, Adapter for Transmission and Other Dipstick Tubes



Lisle

FLUID HANDLING

Fluid Extractors

Change fluids quickly and easily anytime. No mess, no clean up.
Simply remove the dipstick and insert the tube.

OEM TOOLS

All OEMTOOLS Fluid Extractors Include:



Quick Connect



Automatic Shut Off Valve Prevents Overflowing



No Leaks - Solid One-Piece Tank

- Single Piece Reservoir Structure Features a Leak Proof Bottom
- Overflow Shut Off Valve Prevents Fluid from Overflowing
- Use to Extract Most Fluid Types: Engine Oil, Transmission Fluid, Gear Oil, Coolant and Power Steering Fluid
- Updated 41" Extended Dipstick Hose Adapter for Longer Reach and Broader Applications

Manual Fluid Extractors

- Reservoir with Hand Operated Pump to Tackle Big Jobs



Manual Function



1.4 Gallons (5.6 Qts.)
SKU 544744 24389 **129⁹⁹**

2.1 Gallons (8.4 Qts.)
SKU 666877 24936 **144⁹⁹**

2.5 Gallons (10 Qts.)
SKU 547010 24397 **178⁹⁹**

Pneumatic/Manual Fluid Extractors

- Working psi: 85; Max. psi: 120
- Air Consumption: 6.5 CFM



Pneumatic or Manual Function



1.5 Gallons (6.3 Qts.)
SKU 666978 24937 **163⁹⁹**

2.5 Gallons (10 Qts.)
SKU 666881 24938 **179⁹⁹**

Brake Bleeder Adapter Hose for Fluid Evacuators

SKU 568479 24446 **28⁹⁹**

- Use with OEMTOOLS Fluid Evacuators, Converting Them into One-Person Vacuum Brake or Hydraulic Clutch Bleeders
- Universal Bleed Screw Adapter



Replacement Dipstick and Tube Adapter

SKU 1442595 24938-2 **22⁹⁹**

- 1/4" x 17" PVC Hose



Main Suction Hose Replacement

SKU 1442592 24938-1 **29⁹⁹**

- Replacement for OEMTOOLS 24938, 24937, 24397, 24389 and 24936



Fluid Evacuators

Fluid Evacuator (1.9 Gallon)

SKU 594882 24446 **159⁹⁹**

- Integrated 1.9 Gallon (7.3 Liter) Capacity Reservoir
- Evacuates All Kinds of Fluids Including Engine Oil, Transmission Fluids, Gear Oil, Coolant, Brake Fluid and More



PneumatVac Fluid Evacuator (2.3 Gallon)

SKU 497203 24446 **189⁹⁹**

- Operates on Compressed Air
- Independent Air Shut-Off Valve



Fluid Evacuator Plus

SKU 497200 24446 **194⁹⁹**

- Evacuates or Dispenses at the Push of a Button
- Integrated 2.3 Gallon (8.8 Liter) Capacity Reservoir
- Durable, Chemical Resistant Polyethylene Construction
- Dipstick Tube Adapters Included



Mityvac

Fluid Extractors and Fillers

Mityvac

1.5 L Fluid Extractor/Dispenser

SKU 606541 24446 **93⁹⁹**

- Simple Manual Syringe-Type Action Quickly and Cleanly Extracts or Dispenses Fluid
- Integrated Valve and Cap to Prevent Spills and Leaks
- Compact, Streamlined Design Allows Access into Tight Spaces
- Ideal for Evacuating or Topping Off Fluid Reservoirs
- Easy to Clean; Hose and Seals are Simple to Replace



1.5 L Fuel Extraction Syringe

SKU OSB 24446 **114⁹⁹**

- Ideal for Evacuating or Priming Diesel Fuel Systems
- 2 Adapter Hoses: 10 mm Male to 3/8" or 5/16" Female Fuel System Connections
- 3 Male-to-Male Adapters: 10 mm Male to a Barbed, 3/8" or 5/16" Male Connection

For OSB, Call 901-300-4878



Fluid Siphon Pump

SKU 568475 24863 **31⁹⁹**

- Easily Transfers Gas, Water, Oil and Other Non-Corrosive Liquids
- Hose Reach: 6' with 1/2" Diameter



500 cc Fluid Extractor and Filler

SKU 1544658 25572 **23⁹⁹**

- Use to Extract and Refill Many Common Automotive Fluids, Including Brake Fluid
- Dual Scale Molded into Cylinder Body (Qt/mL)
- Translucent Cylinder Body to Easily Read Volume Extracted and Fluid Condition
- 500 cc Volume and Suction Tubes Enable Faster, More Efficient Fluid Transfer



OEM TOOLS

Transmission Fluid Fill Adapter

SKU 1125880 25740 **5⁹⁹**

- Required Tool to Fill or Add Fluid to the 5R55W Automatic Transmission
- Used in Many Ford Vehicles (2003 - Newer) Same as Ford No. 307-437

OEM TOOLS



Fluid Management



ATF Refill Kit, 5 L

SKU 265092
MITMV6410A **484⁹⁹**

- Fluid is Dispensed Under Pressure for Smooth Continual Flow
- Integrated Manual Pump Adds Air Above the Fluid Level to Prevent Aeration
- Internal Pump Components are Sealed Against Exposure to Fluids
- Flow Control Valve is Conveniently Located Near Fluid Output
- Features Integrated Safety and Manual Pressure Relief Valve



Pneumatic ATF Refill Kit, 10 L

SKU 1330680
MITMV7412 **539⁹⁹**

- Utilizes Compressed "Shop-Air" to Produce Pressure for Fluid Dispensing



ATF Refill Adapters with Hose

SKU 1361999
MITMV7216A **274⁹⁹**

Quickly Converts the Mityvac MITMV7201 Fluid Evacuator Plus into a Professional Tool for Refilling Sealed Automatic Transmissions

- 13 Quick-Change ATF Refill Adapters Fit Most Vehicle Transmissions



Pneumatic Powered Gear Oil Dispenser

SKU 1544685
MITMV7454 **439⁹⁹**

- 10 Liter Pneumatic Pump Gear Oil Dispense Bottle with Low Restriction Hose, Valve and Nozzle
- Powered by Compressed Air
- 10 Liter Reservoir for Larger Dispensing/Longer Refill Intervals
- Can be Pressurized and Disconnected from Compressed Air Source for Convenience
- Easily Replaceable Tubing for Repair or Customization of Unit to Job Requirements



Hand Pump Powered Gear Oil Dispenser

SKU 1544672
MITMV7455 **339⁹⁹**

- 10 Liter Hand Pump Gear Oil Dispense Bottle with Low Restriction Hose, Valve and Nozzle
- 10 Liter Reservoir for Larger Dispensing/Longer Refill Intervals
- Hand Pump Supplies Compressed Air to Power Unit
- Manual Pump to Compress Air; Nothing but Pressurized Air Moves Fluid which Lessens Risk of Contamination
- Fluid Level Indications on Reservoir to Monitor Fluid Levels



Manual ATF Filler System

SKU 526508
24441 **149⁹⁹**

- Complete System for Servicing Sealed Automatic Transmissions
- Includes Adapters to Fit Ford, BMW, Honda, Nissan, VW, Porsche, MINI, Audi and Mercedes-Benz
- Transmissions Reservoir Capacity: 3 Liters (3.1 Quarts)
- Adapters Included:
 - DSG M24 x 1.5,
 - CVT M22 x 1.5,
 - CVT M12 x 1.5,
 - ATF M10 x 1.0,
 - ATF 1/8 NPT - 27,
 - ATF 04, ATF 03 and ATF 02



Universal Fluid Dispensing System

SKU 265093
MITMV6400 **264⁹⁹**

- Large 1.2 Gallon (5 Liter) Fluid Capacity
- Integrated Manual Pump Adds Air Above the Fluid Level to Prevent Aeration
- Pressure Gauge Indicates Fluid Dispensing Pressure
- Safety and Manual Pressure Relief Valve
- Vehicle Adapters Not Included



DEF Fluid Extractor 1.5 L

SKU 1089032
LIN617 **84⁹⁹**

- Integrated Valve and Cap to Prevent Spills and Leaks
- Ideal for Evacuating or Topping Off DEF Reservoirs
- Simple Manual Syringe-Type Action Extracts or Dispenses DEF Quickly
- Disassembles Easily for Cleaning
- 16" Clear Hose is DEF Compatible



Battery-Operated Liquid Transfer Pump

SKU 1414413
87230 **15⁹⁹**

- Move Liquids Safely and Easily with this Convenient Handheld Pump
- Use in Garage, Aquariums, Home and Yard
- Pumps Up to 6 Quarts of Liquid per Minute
- Battery Operated (2 "D" Batteries)

Great for Use with Generators



FLUID HANDLING

Lever Action Pumps

OEM TOOLS

Lever Action Hand Oil Pump

SKU 462495 24381 **42⁹⁹**

- Oil Pump for Use with Oil-Based Fluids, Heating Oils, Motor Oils, Heavy and Light Oils, Diesel and Kerosene
- Built-In 1-1/2" and 2" Bung for Use on 16 to 55 Gallon Drums with Either Opening
- Not for Gasoline or DEF



OEM TOOLS

Lever Action Barrel Pump - Polypropylene

SKU 688036 24471 **69⁹⁹**

- Lever Action Pump, Self-Priming
- Ideal for Diesel, Kerosene, Lubricants and Other Oils
- Not for Gasoline, Water Based Chemicals or DEF
- Maximum Flow Rate: 12 Oz. per Stroke
- Maximum Viscosity: 40 Wt. Oil



OEM TOOLS

Lever Action Barrel Pump Polypropylene Stainless Steel Rod

SKU 688038 24472 **59⁹⁹**

- Ideal for Pumping Diesel, Oils, Kerosene, Water-Based Chemicals, Bases and Mild Acids
- Not for Gasoline or DEF



OEM TOOLS

Lever Action Barrel Pump - Ryton® Stainless Steel Rod

SKU 688037 24473 **89⁹⁹**

- Ideal for Pumping Diesel, Oils, Kerosene, Water-Based Chemicals, Bases and Acids Including DEF
- Not for Gasoline

DEF COMPATIBLE



LINCOLN

Lever Action Barrel Pump

SKU 970530 LIN1340 **99⁹⁹**

- Pumps Non-Corrosive Fluids, Not for Gasoline
- Telescoping Tube for 16 to 55 Gallon Drums
- Removable Non-Drip Spout Allows for Threaded Hose Connection



Rotary Pumps

OEM TOOLS

Rotary Barrel Pump

SKU 462486 24382 **54⁹⁹**

- Fluid Transfer Pump for Use with Oil-Based Fluids, Heating Oils, Motor Oils, ATF, Diesel and Kerosene
- Not for Gasoline or DEF



OEM TOOLS

Polypropylene Rotary Drum Pump

SKU 688035 24470 **129⁹⁹**

- Ideal for Pumping Diesel, Oils, Kerosene, Water-Based Chemicals, Bases and Mild Acids
- Not for Gasoline or DEF



Manual Rotary Oil Pump with Hose for 55 Gallon Drums

SKU 265089 LIN1385H **274⁹⁹**

- Includes: 8 Ft. x 3/4" Anti-Static Hose with Non-Sparking Aluminum Nozzle with Hanger; Seal Tight Telescoping Pick-Up Tube with Strainer for 16 to 55 Gallon Drums with 2" Bung



LINCOLN

Manual Rotary Fuel Pump with Hose for 55 Gallon Drums

SKU 265088 LIN1387 **394⁹⁹**

- 3 Vane Manual Rotary Pump for Most Fluid Types Including Gasoline, Diesel, Kerosene, Coolant, Non-Corrosive Materials, Medium Viscosity Petroleum Based Fluids, Hydraulic Oils and ATF



LINCOLN

Manual Rotary Pump for 55 Gallon Drums

SKU 462977 LIN1385 **214⁹⁹**

- Hose Not Included

Drum Not Included

Drum Wrench

OEM TOOLS

Aluminum Drum Bung Wrench

SKU 1267963 22664 **28⁹⁹**

- Comfortable and Textured Grip for Ease of Use
- Non-Sparking, Non-Corrosive Aluminum Construction
- Fits Most Steel and Plastic Caps, Including 3/4" Vent Plugs
- Effortlessly Opens and Tightens Bungs to Guarantee Drum Contents are Safe
- Opens 10, 15, 20, 30 and 55 Gallon Barrels



Fuel Transfer Pump

JD JohnDow Industries

25 Gallon Steel Gas Caddy

SKU 360585 DOWFC25GC **1,079⁹⁹**

- UL Approved
- 25 Gallon Tank is Constructed of 14" Gauge Steel for Use with Unleaded Gasoline, Kerosene, Ethanol E85, Diesel and Bio-Diesel Fuels



DEF Pump

LINCOLN

Lift Action Pump

SKU 1142361 LIN1390 **184⁹⁹**

- Transfers Popular Shop Fluids Including Acetone, Antifreeze, Windshield Washer, Thinners and More
- Includes NPT and Buttress Threads for Steel and Plastic Drums
- Adjustable Bung Type Fits 15, 16, 30 and 55-Gallon Drums
- Welded Ground-Post for Safe Dispensing of Volatile Fluids
- Premium Grade 316 Stainless Steel
- Self-Priming

DEF COMPATIBLE



Grease Pump

LINCOLN

Manual Gear Lube Dispenser

SKU 174166 LIN1293 **159⁹⁹**

- 5' Hose, 13" Pump Tube
- Fits 25 to 50 Lb. 5 Gallon Containers
- Delivers 1 Oz. per Stroke



Lube Tech Set

SKU 227302 | 24965

1,899⁹⁹

REG. \$2,252.39

OEM TOOLS

SAVE \$352

Includes 160 of the Most Common Tools in Tool Cart

- SAE and Metric, 1/4", 3/8" Drive Tools, Combination Wrench Sets, Pliers and Screwdrivers. Plus Battery Service Tools, Oil Change Tools and More



Cart Style and Color May Vary

Go to AZTOOL1.com for 24965 Contents List

Offer Good Through September 30, 2026

Oil and Grease

Oil Control Handle with Digital Meter

SKU 1485049 **334⁹⁹**
BAL3330-159

- Enclosed Digital Meter Protects Against Shop Wear
- Auto Shut-Off Valve for Controlled Flow
- Flexible Spout for Hard-to-Reach Areas
- Serviceable Design with Replaceable Components



Electronic Preset Oil Meter Handle

SKU OSB **649⁹⁹**
BAL3331-032

- Preset Functionality for Exact Fluid Delivery
- Large Digital Display for Easy Reading
- Improves Speed and Consistency in Repetitive Jobs
- Ideal for Precision-Focused Applications



Lynx 3:1 Universal Stub Pump

SKU 1580956 **469⁹⁹**
BAL1110-007

- Reliable Air Motor Design that Features Corrosion Resistant Materials
- Double-Acting Pump Design for Smooth and Accurate Fluid Delivery
- Includes 2" Bung-Adapter



Tank Package

SKU OSB **4,349⁹⁹**
BAL1135-017

- 50' EVO Reel
- Lynx 5:1 HD Pump
- 275 Gal Double Wall Construction
- UL 2258 Certified
- Compatible Fluids: DEF, Diesel and Lubricants
- Package Assembled from Factory



5:1 HD Oil Pump Drum Package

SKU OSB **2,449⁹⁹**
BAL1131-069

- Reliable Air Motor Design that Features Corrosion Resistant Materials
- Includes: Heavy-Duty Drum Cart with Semi-Pneumatic 10" Tires, Front Caster with Brake to Steady Cart While in Use, 50' x 1/2" Hose Reel and Electronic Metered Handle



Drum Not Included

Lynx 55:1 Pump Package

SKU OSB **1,389⁹⁹**
BAL1151-036

- Reliable Air Motor Design that Features Corrosion Resistant Materials
- Double-Acting Pump Design
- Optional Hose Reel Mounting Kit

Lynx 55:1 Portable Grease 120 Lb. Package

SKU OSB **954⁹⁹**
BAL1151-028



Drum Not Included

Used Fluid Drains

- All-Steel Tank and Base
- Easy-to-Use Patented Cantilever Mechanism

23 Gallon Oil Drain

SKU 1485039 **919⁹⁹**
BAL4110-024

- Powder-Coated Black
- 1" Cam-Lock Fitting

23 Gallon Anti-Freeze Drain

SKU 1485042 **874⁹⁹**
BAL4110-025

- Powder-Coated Green
- 3/4" Cam-Lock Fitting

Premium Drains Capture Used Fluids and Transfer Them to Any Bulk Storage Tank Using a Cam-Lock Kit and Evacuation System



BAL4110-024

Balcrank
Fluid Dispensing Systems
MADE IN USA

Filter Crusher

Industrial 10 Ton Oil Filter/Can Crusher

SKU 990215 **2,479⁹⁹**
RANRP20FC

- Reduces Used Oil Filters to 1/4 of the Original Size
- 20,000 Lb. Crushing Power
- 100% Air Operated for Minimal Maintenance
- Save on Disposal Costs and Storage Space
- Automatic Safety Door Stops Operation When Opened
- Pressure Regulator and Air Moisture Separator Come Standard
- Transparent Door for a Convenient View of the Crushing Process
- Welded Steel Plate Construction
- Exclusive X-Shape Bevel in Press Head Pre-Aligns Filters for Absolute Vertical Press



INCLUDES STAND

Ranger

Used Oil Evacuation

- Includes: All Necessary Fitting, Brackets, Valves, Hoses and Components for Seamless Integration with Air System and Fluid Collection/Discharge Processes

3/4" Evacuation Package for Used Antifreeze

SKU 1485050 **1,919⁹⁹**
BAL1121-025

1" Evacuation Package for Used Oil

SKU 1485032 **1,989⁹⁹**
BAL1121-024



Balcrank
Fluid Dispensing Systems

To Confirm Price, Availability and Ordering Instructions on OSB Call 901-300-4878

Prices subject to change without notice. Prices do not include applicable taxes, vehicles, tires, rims, installation or optional equipment as shown. Please do not return purchases to the store. For information regarding warranty, repair, or any questions or concerns, call 901-300-4878.

FLUID HANDLING

Fluid Exchangers

Brake Flush Machine with Adapters

SKU **OSB**
FLDBRKMATEJR **3,949⁹⁹**

- 12V Pressure Exchanger and Brake Flush Machine
- 5 Qt New Tank with Low-Fluid Shutoff
- 1 to 59 psi Regulated Pressure Control
- Includes Master Cylinder Adapter Set
- Hybrid System Capable



TSD 450 LCD Automatic Transmission Fluid Exchanger

SKU **OSB**
FLDTSD450LCD **6,749⁹⁹**

- Fully Automatic In-Line and Dipstick Exchange
- 24 Quart Tanks/Up to 21 Quart Exchange Capability
- LCD Screen Prompts with Quart Counter
- Add/Remove Fluid Buttons for Proper Level Control



Heated Cooler Line Flusher, 10 Gallon

SKU **OSB**
FLDGTECTTCF8 **6,749⁹⁹**

- Heated Flusher Helps Reduce Comebacks
- 10 Gallon Heated Steel Tank
- Oberg 64 Micron Filter Shows Removed Debris
- Extensive Adapter Coverage for Many Makes/Models
- Cleans Cooler Lines and Heat Exchanger Before Install



ATX280 Trans Fluid Exchange Unit

SKU **OSB**
MSS4008002300
5,999⁹⁹

- 7" Touchscreen LCD Display with Graphical Interface
- Onboard Additive Tank for Detergent/Oil Injection



Fluid Not Included

Trans-Tech 4 Plus

SKU **305858**
MVC500-1125B **5,429⁹⁹**

- Automatic, In-Line Exchange Through Vehicle Cooler Line
- ATF Exchange Through Vehicle Transmission Dipstick
- Drain Pan Feature
- 26 Quart New Fluid Reservoir
- High Volume Pump for Rapid and Efficient Service
- Comes with Standard Set of Adapters
- Uses MVC400-0137 2-Part ATF Cleaner and Conditioner Fluid

Trans-Tech 2-Step ATF Cleaner and Conditioner Case of 6 Kits

SKU **OSB**
MVC400-0137
144⁹⁹

- Each Kit Includes:
1 Bottle of ATF Fluid Cleaner and
1 Bottle of ATF Fluid Conditioner



Fluid Not Included

BFX-20 Brake Fluid Exchanger

SKU **OSB**
MSS4258001400
2,429⁹⁹

- Hydraulic Pump
- Suitable for ABS, ESP, EDS and SBC
- Adapters Included



Fluid Not Included

BFX-10 Brake Fluid Exchanger

SKU **OSB**
MSS4258001600
1,249⁹⁹

- Suitable for ABS, ESP, EDS and SBC
- Hydraulic Pump
- Two Universal Adapters Included



Fluid Not Included

BrakeVac™ III Premium Brake Fluid Flush System

SKU **OSB**
MVC500-8200 **1,550⁹⁹**

- Exchanges DOT3, DOT4 and DOT5 Brake Fluids
- Pulsating Flow Helps Eliminate Air Issues
- Automatic Shut-Off When Source Brake Fluid is Empty
- One-Person Operation
- Includes: Brake Adapter Set



Fluid Not Included

To Confirm Price, Availability and Ordering Instructions on OSB, Call 901-300-4878

COOLING SYSTEM

TO ORDER, contact your Commercial Sales Manager or go to AutoZonePro.com

COOLING SYSTEM

Pressure Testers

OEM TOOLS®

Universal Cooling System Adapter Set

SKU 434723 **89⁹⁹**
27067

- Designed to Fit Most Passenger Vehicles and Light Duty Trucks
- Fits Both Radiators and Plastic Reservoirs
- Universal Design Works with Any Cooling System Pressure Pump
- Prevents Damage to Plastic Reservoir Threads That Occurs When the Wrong Adapter is Forced On
- Pressure Test Pump Not Included

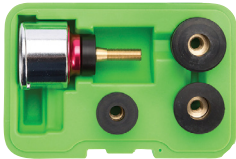

Cooling System Pressure Test Pump

SKU 434722 **99⁹⁹**
27069

- Quickly and Easily Pressure Test Cooling Systems in Most Vehicles
- High Quality Pressure Pump Designed to Work with Most Cooling System Adapters
- Easy-to-Use Lever Style Pressure Relief Valve



Universal Cooling System Pressure Test Kit

SKU OSB **144⁹⁹**
27068

- Quickly and Easily Pressure Test Cooling Systems in Most Vehicles
- Includes: 3 Expandable Adapters that Take the Place of Numerous Specialized Adapters
- Easy Lever Style Pressure Relief Valve
- Prevents Damage to Plastic Reservoir Threads that Occurs When the Wrong Adapter is Forced on



For OSB, Call 901-300-4878

Heavy Duty Cooling Test and Refill Kit

SKU 954220 **129⁹⁹**
MSC43014

- Includes: Vacuum Gauge, Sealing Collar, Valve, Rubber Gaskets and Coolant/Draining Hoses
- Sealing Collar (with Rubber Cone) Offers a Wide Variety of Applications for Radiator Filler Necks
- Minimizes the Risk of Engine Overheating
- 2.3 Gallons per Minute Fill Rate



Mastercool®
World Class Quality

Heavy Duty Cooling Kit

SKU 954231 **499⁹⁹**
MSC43306

- Includes: Heavy Duty Vehicle Adapters, Pressure Test Regulator, Vacuum Refill Attachment with Tubing in a Plastic Case
- For Use with Freightliner, International, Kenworth, Peterbilt, Mack, Volvo, GMC and Sterling Cooling Systems
- Uses Shop Air to Pressure Check and Vacuum Refill
- 4 Quick-Disconnect Vacuum Attachments Provide Quick Refilling of the Cooling System and Eradicates Airlocks



Mastercool®
World Class Quality

27 Piece Master Radiator Pressure Test Kit

SKU 1053958 **384⁹⁹**
MSC43301-A

- Includes: 1 Blue Radiator Cap Test Connector R123/R125, 1 Black Radiator Cap Test Connector R123/R124, 1 Thermometer, 1 Universal Radiator Cap, 1 Vacuum Purge and Refill Tool, Coolant Hose and Additional Installation Accessories, 1 Hand Pump and 19 Adapters (Nos. 2 to 4, 6 to 21) to Fit Most Popular Domestic and Import Cars and Trucks



Mastercool®
World Class Quality

Cooling System Adapters

Volvo, Saab, Jeep, Maserati, Ferrari Radiator Adapter

SKU 133600 **44⁹⁹**
27241R

- Fits Maserati and Ferrari Models (2000 - Newer), Jeeps with Male Threads (1990 - 1994), Saab 900 (1978 - 1993), Saab 900 (Drop Top 1994), Saab 9000 (1987 - 1998), Volvos with Male Threaded Necks
- Diameter: 45 mm; Thread Size: 3 mm



GM Radiator Adapter

SKU 133621 **49⁹⁹**
27118R

- Fits Many GM, Chrysler, Ford, Jaguar and Freightliner Models



Audi and VW Radiator Adapter

SKU 133625 **44⁹⁹**
27245R

- Fits Audi A4 (1996 - Newer), A6 (1998 - Newer), A8 (1997 - Newer), S4 (2004 - Newer), TT (2000 - Newer), Bentley (2006 - Newer), Lamborghini (2006 - Newer), Porsche Cayenne (2003 - Newer), Porsche Panamera (2010 - Newer), Volkswagen Passat (1998 - Newer), Beetle (1998 - Newer), Golf and Jetta (1999 - Newer)



OEM TOOLS®

Mercedes and Chrysler

SKU 133626 **49⁹⁹**
27246R

- Use with Any Standard Pressure Tester
- Fits Mercedes-Benz with Threaded Filler Necks (Except M-Class 1998 - 2005) and Chrysler Crossfire (2004 - 2008)
- Diameter: 62 mm
- Thread Size: 4 mm



Mazda 3, Volvo S40/V50 and Ford Radiator Adapter

SKU 133633 **49⁹⁹**
27249R

- Fits Land Rover LR-2 (2008 - Newer), Mazda 3 (2004 - Newer), Volvo S40 and V50 (2004 - Newer), XC60 (2010 - Newer), Ford Fusion and Escape (2012 - Newer)
- Diameter: 50 mm; Thread Size: 2.5 mm



Toyota, Lexus and Scion Radiator Adapter

SKU 133632 **42⁹⁹**
27248R

- Fits Lexus LS (2007 - Newer), Toyota Celica (2000 - Newer), Spyder MR2 (2000 - Newer), RAV4 (2009 - Newer), Prius (2004 and Newer), Camry (2007 - Newer), Highlander (2006 - Newer) and Scion XB (2008 - Newer)
- Diameter: 34 mm; Thread Size: 3 mm



Ford, Jaguar, Pontiac, Range Rover and Saab Radiator Adapter

SKU 133611 **44⁹⁹**
27243R

- Fits Jaguar X Type (2002 - Newer), Saab 900 (1994 - 1998), Saab 9-3 and 9-5 (1999 - Newer), Some Saturns and Other Vehicles
- Diameter: 52 mm; Thread Size: 3 mm



VW Radiator Adapter

SKU 133609 **44⁹⁹**
27242R

- Volkswagens with Female Threaded Filler Necks (1990 to 1998)
- Diameter: 57 mm; Thread Size: 3 mm



Ford, Jaguar and Mazda Radiator Adapter

SKU 133631 **44⁹⁹**
27247R

- Ford Contour 1998-2000, Jaguar XJ8 1998-Up, Jaguar XK8 1997-2006, Mazda Tribute 2001-Up
- Diameter: 52 mm; Thread Size: 3 mm



Prices subject to change without notice. Prices do not include applicable taxes, vehicles, tires, rims, installation or optional equipment as shown. Please do not return purchases to the store. For information regarding warranty, repair, or any questions or concerns, call 901-300-4878.

AZG0326

COOLING SYSTEM

Coolant Funnels

Professional No-Spill Coolant Funnel Kit

SKU 943142 **39⁹⁹**
87043

- 5 Spring-Loaded Adapters for a Secure Fit
- Simply Select the Correct Adapter, Attach the Funnel and Fill
- Air-Release Tubes to Vent the System During Refilling Process
- Stopper Prevents Dripping When Removing the Funnel
- Includes: Extensions and Adapters for Hard-to-Reach Surge Tanks



No-Spill Coolant Filling Funnel Kit

SKU 802197 **19⁹⁹**
87007

- 4 Radiator Cap Adapters to Fit Most Passenger and Light Trucks
- Simply Select Correct Adapter, Thread Together, Attach the Funnel and Fill
- Rotary Switch to Effectively Prevent Drips and Spills, and Stop Overflow and Bubbles
- Includes: 5 Adapters, (2) 45° Elbows and (2) 5" Extension Rods for Difficult-to-Reach Areas



STORE STOCKED

Drip-Free Funnel for Automotive Fluids

SKU 1142569 **37⁹⁹**
87041

- Designed for Easy Refilling of Automotive Cooling Systems and Other Automotive Fluids
- Funnel Features a Fluid Stopper to Prevent Drips when Removing the Funnel
- Includes: (2) 45° Angled Adapters and 5" Extension for Accessing Hard-To-Reach Spots



Leak Tester

OEM TOOLS®

Gas Engine Combustion Leak Tester

SKU 1103608 **29⁹⁹**
37145

- Used to Test for Combustion Leaks That Result from Head Gasket, Cylinder Head and Engine Block Leaks
- Pulls Air from the Cooling System Up Through the Leak Tester; if Carbon Dioxide is Present, the Leak Tester Fluid Color Will Change to Yellow Signifying a Combustion Leak



Combustion Leak Detector Fluid (8 Oz.)

SKU 391381 **9⁰⁰**
25739

- Test for Internal Combustion Leaks on Gasoline Engines Fluid Turns Yellow When Exhaust Gases are Present in Cooling System
- Designed for Use with 37145 Combustion Leak Detector (Not Included)
- Can Be Used with Other Combustion Leak Testers, See Manufacturer's Manual Prior to Use
- Not for Use with Diesel Engines



STORE STOCKED

AirEvac Cooling System

AirEvac Cooling System Refiller

SKU 568478 **135⁹⁹**
24444

- Quickly Refills Cooling System and Eliminates Trapped Air
- Helps Prevent Come-Backs and the Threat of Engine Damage
- Universal Adapter Forms an Airtight Seal with Most Radiator and Coolant Bottle Necks
- Performs Vacuum Leak Tests
- Covers Most Radiator and Reservoir Types
- No Custom Adapters Required
- Comes in Sturdy, Green Blow Mold Case



AirEvac Cooling System Kit

SKU 099292 **99⁹⁹**
27066

- Uses Shop Air to Evacuate the Cooling System for Vacuum Leak Testing
- Refills Cooling System without Trapping Air That Causes Overheating
- Universal Adapter Forms an Airtight Seal with Both Radiators and Coolant Reservoirs
- Self-Locking Quick Disconnects for Fast Assembly



OEM TOOLS®

Flush Tools

Cooling System Back Flush Tool

SKU 750008 **52⁹⁹** REG. \$64.99
24506

- Non-Corrosive Aluminum
- Easy to Use
- Connects to Standard Hose 1/2", 5/8" and 3/4" Hose Fittings
- Made of Non-Corrosive Aluminum



Offer Good Through September 30, 2026

SAVE \$12

Coolant System Flush Gun

SKU 1284967 **59⁹⁹**
24719

- Universal Nozzle to Fit Various Radiator or Heater Hoses
- Combines Water with Compressed Air to Quickly and Efficiently Flush Cooling Systems
- Comfortable Lever-Action Air Throttle with Lock-On Latch for Simple Attachment of Air Hoses
- Used for the Detailed Flushing of Debris and Contaminants from the Cooling System During Repair and Maintenance



OEM TOOLS®

COOLING SYSTEM

TO ORDER, contact your Commercial Sales Manager or go to AutoZonePro.com

COOLING SYSTEM

Cooling System Tools

4 Piece 14" Jumbo Pick Set

SKU 94658
25940 **43⁹⁹**

- Includes: Straight Pick, 90° Pick, Offset Pick and Hook Pick



OEM TOOLS®

Clic-R Hose Clamp Pliers

SKU 1089038
25102 **9⁹⁹**

- Easily Remove or Install Clic-R Type High Tension Clamps
- Heavy Duty and Durable Steel Construction
- Clamps Commonly Found on BMW, Mercedes-Benz, Audi, VW and Other Cars and SUVs



5 Piece Hose Remover Set

SKU 1335785
26519 **18⁹⁹**

- Dual Durometer Handles for Comfort and Grip
- Hooks and Picks are Assembled from Carbon Steel for Strength and Durability
- Perfect for the Removal of Coolant Hoses, Cotter Pins Brake Springs, Large Electrical Connectors and More

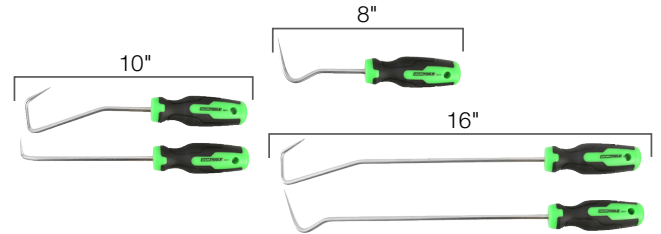

2.4 Gallon Plastic Radiator Filler

SKU 754738
87104 **27⁹⁹**

- Impervious to Oil, Gasoline and Antifreeze
- Stands Up to Extreme Weather



Hose Clamp Pliers

SKU 607069
25246 **26⁹⁹**

- Removes and Installs Flat Band Spring Style Hose Clamps with Diameters of 11/16" to 2-1/2"
- Multi-Position Lock Holds Clamps Open for Hands-Free Operation
- Engineered For Maximum Strength

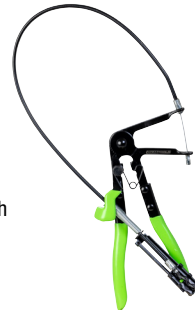

Master Freeze Plug Installer Kit

SKU 965837
27208 **119⁹⁹**

- Designed to Remove and Install Freeze Plugs Used in Liquid-Cooled Gas and Diesel Engines



Professional Series Ethylene Glycol Antifreeze Tester

SKU 750007
24507 **14⁹⁹**

- For Testing Hot or Cold Ethylene Glycol-Based Coolants, Including Dex-Cool®
- Easy-to-Read Discs are Magnified by Convex Design of the Clear, Thermal Resistant Plastic Barrel
- Disc-Type 16-1/4" Tester is Accurate at All Temperatures (Celsius and Fahrenheit Scales)



(Color May Vary)

Water Pump Holding Tool

SKU 1069120
26060 **23⁹⁹**

- Holds the Timing Chain and Gear in Place While Removing or Installing Water Pump on Ecotec Engines
- Securely Holds Water Pump Sprocket Preventing Loss of Timing or Damage to the Engine
- Special Half-Moon Design Allows Easier Access to Water Pump Gear Bolts
- Uses Access Cover Bolts to Hold the Tool in Place



Coolant Exchangers

VCX-1 Vacuum Coolant Exchanger

SKU 573048
MSS4708001900 **3,129⁹⁹**

- Extremely Fast Service Cycles
- Simple Hook-Up and Operation
- Flexible Adaptation for Most Makes and Models



Coolant Not Included

FluidPRO® MCX-2 Multi-Coolant System Fluid Exchanger

SKU 574749
MSS4708003000 **3,229⁹⁹**

- Includes System Pressure Test Feature and "Hot Car" Radiator Cap Pressure Release
- Compatible with All Coolant Types for Adaptability
- Contains (2) 7.5 Gallon New Coolant Tanks and (1) 15 Gallon Waste Tank Providing Simple, Rapid Switching from One Coolant to Another
- 3 Minute Service Time for Increased Productivity



Coolant Not Included

MAHLE

Used Fluid Drain

Balcrank
Fluid Dispensing Systems

23 Gallon Anti-Freeze Drain

SKU 1485042
BAL4110-025 **874⁹⁹**

- Powder-Coated Green
- 3/4" Cam-Lock Fitting
- All-Steel Tank and Base
- Easy-to-Use Patented Cantilever Mechanism

Premium Drains Capture Used Fluids and Transfer Them to Any Bulk Storage Tank Using a Cam-Lock Kit and Evacuation System



MADE IN USA



Prices subject to change without notice. Prices do not include applicable taxes, vehicles, tires, rims, installation or optional equipment as shown. Please do not return purchases to the store. For information regarding warranty, repair, or any questions or concerns, call 901-300-4878.

AZG0326

51

SPECIALTY TOOLS

Line Repair Tools

OEM TOOLS®

Double Flaring Tool Set

SKU 864647 **39⁹⁹**
25358

- Includes: 5 Adapters: 3/16", 1/4", 5/16", 3/8" and 1/2"
- Chrome Swivel Made of Alloy Steel to Reduce Friction
- Forged Yoke Made with Heat-Treated Steel



Single Flaring Tool

SKU 141503 **18⁹⁹**
25359

- Ideal for Making 45° Flares in Copper, Aluminum, Brass and Mild Steel Tubing
- Suitable for Tubing Sizes: 3/16", 1/4", 5/16", 3/8", 1/2" and 5/8"
- Makes a Precise Leak-Proof Flare That Fits Properly on Standard Fittings
- Flaring Bars are Heat-Treated for Durability



Bubble Flaring Tool Kit

SKU 592261 **49⁹⁹**
27214

- Designed for Metric Soft Steel Brake Lines Where an "ISO" or Bubble Style Flare is Required
- Forged Yoke is Made of Heat-Treated Steel
- Includes: Flaring Bar, All Adapters Needed for ISO Bubble Flaring and 4 Dies (4.75, 6, 8 and 10 mm)



Fuel Line Repair Assortment Kit

SKU 1392319 **154⁹⁹**
DYNDY-FLA-2

- Kit Includes: 23 of the Top Selling Connectors, Fittings and Clamps
- 86 Total Pieces



Dynamic

Pro Series Repair Assortment

SKU 1125882 **517⁹⁹**
AIR78019

- Everything You Need for Transmission and Power Steering Line Repair in One Convenient Kit - 16 Repairs
- 5 Minute Line Repair
- Leak-Free to 2,600 psi
- OE Approved



AIRSEPT
PART SMART

Universal Flaring Set

SKU 954227 **619⁹⁹**
MSC72475-PRC

- Create Perfect Production Quality Flares
- Magnetic Adapter Holder Keeps Adapters in Place
- Tube and Die Set Stabilizing Arm for Easy Tube Forming
- Enlarged Die Set Compression Area for Better Grip of Dies



Mastercool®
"World Class Quality"

Disconnect Tools

OEM TOOLS®

NAVISTAR® MAXXFORCE® Fuel Line Disconnect Tool Set - 4 Piece

SKU 004112 **34⁹⁹** **SAVE \$15**
25031 REG. \$49.99

- 4 Piece Disconnect Tool Set for NAVISTAR® MAXXFORCE® Series 11 and 13 Engines
- Sized to Depress Fuel Release Tabs for Efficient Fuel Line Removal
- 1 Straight and (1) 90° Tool for 11.8 mm Fuel Lines; 1 Straight and (1) 90° Tool for 16 mm Fuel Lines



Offer Good Through September 30, 2026

Fuel Line Disconnect Pliers

SKU OSB **15⁹⁹**
25241

- Easily Remove or Attach Fuel Lines with Pinch-Style Tabs
- Offset Grip Design for Improved Leverage Around Fuel Lines in Tight Spaces
- Jaw Has Full Range of Motion for Grabbing Wires or Hoses



For OSB, Call 901-300-4878

6 Piece Disconnect Set

SKU 13603 **26⁹⁹**
24681

- Different Colors for Easy Identification
- Unique Offset Design Allows for Access in Confined or Obstructed Areas
- Sizes: 5/16", 3/8", 1/2", 5/8", 3/4" and 7/8"



Line Disconnect Set

SKU OSB **16⁹⁹**
68941

- Disconnects Fuel Lines and Spring Lock Couplings on Ford and Chrysler
- Sizes: 5/16", 3/8", 1/2", 5/8", 3/4" and 7/8"
- High Quality ABS Plastic that can Easily Stand Up to Daily Usage
- Works on Fuel Lines and Other Quick Disconnect Couplings on Domestic and Import Vehicles
- Angled Handles for Easy Access to Tight Spots
- Sizes Include: 1/4", 5/16", 3/8", 1/2", 5/8", 3/4" and 7/8"



For OSB, Call 901-300-4878

OEM TOOLS®

Angled Disconnect Set

SKU 291416 **29⁹⁹**
LIS39400

- Disconnects Spring Lock Couplings on Ford and Chrysler A/C Lines
- Works on Fuel Lines and Other Quick Disconnect Couplings on Domestic and Import Vehicles
- 6 Sizes: 5/16", 3/8", 1/2", 5/8", 3/4" and 7/8"



Lisle

Master Disconnect Tool Set

SKU 291413 **84⁹⁹**
LIS39900

- Contains 8 Tools for A/C and Fuel Lines
- Comes in a Blow Mold Case



Lisle

Spark Plug Service

3/8" Drive Magnetic Spark Plug 3 Piece Socket Set

SKU 300140 **14⁹⁹**
22891

- Includes: 5/8", 9/16" and 13/16"



Spark Plug Sockets

SKU	Part #	Drive	Size	Features	Price
82923	22880	3/8"	9/16"	Magnetic	13.99
82936	22895	3/8"	14 mm	12 Point Thin-Wall	9.99
82933	22887	3/8"	5/8"	Magnetic	9.99
82929	22881	3/8"	18 mm	Magnetic	7.99
82932	22883	3/8"	13/16"	Magnetic	9.99
1407804	22888	1/2"	5/8"	Magnetic	11.99
82934	22889	1/2"	13/16"	Magnetic	9.99

14 mm x 12 Pt. BMW Spark Plug Socket

SKU 814164 **15⁹⁹**
22814

- Designed with a Universal Joint for the Installation and Removal of Spark Plugs Situated in Tight Spaces
- Durable Chrome Moly Steel Construction
- Overall Length: 3.75"
- Plug Retainer for a Secure Grip



12-POINT

3/8" Drive Magnetic Spark Plug Socket Extra Long (5/8")

SKU 300146 **14⁹⁹**
22885

- Hard Chrome™ Finish is Easy to Clean and Protects Against Rust
- Chamfered Ends Make Fastener Engagement Quick and Smooth
- Magnetic and Won't Wear Out or Be Damaged By Oil
- Deep Marking for Easy Identification Knurling Position for Best Finger Gripping
- Length: 6"



3/8" Drive Magnetic Spark Plug Socket Extra Long (9/16")

SKU 300147 **15⁹⁹**
22886

- Length: 6"



3/8" Drive 14 mm x 12 Pt. Extra Long Spark Plug Socket

SKU 814337 **21⁹⁹**
22813

- Designed with a Universal Joint for the Installation and Removal of Spark Plugs Situated in Tight Spaces
- Durable Chrome Moly Steel Construction
- 12" Extended Reach



12-POINT



Swivel Joint

Adjustable Spark Plug Boot Pliers

SKU 1340226 **23⁹⁹**
25559

- Jaws Adjust to Five Different Positions for Easy Access to Spark Plug Boots
- Rubber Dipped Jaws Provide a Secure Grip for Damage Free Removal of the Spark Plug Boot
- Hardened Jaws Will Not Bend When Gripping
- Dipped Handle Grips for a Comfortable and Sure Grip

OEM TOOLS



Spark Plug Boot Pliers

SKU 390900 **13⁸⁵**
25542

- Designed to Remove Hard-to-Reach Spark Plug Boots
- 45° Offset Jaws for Easy Gripping of Wires and Boots



STORE STOCKED

Spark Plug Wire Puller

SKU 532549 **3⁸⁵**
25061

- Insulates Hands from Electric Shock
- Grips Directly on Boot to Prevent Wire Damage



STORE STOCKED

Specialty Sockets

IPR Socket, 3/8" Drive

SKU 912334 **14⁹⁹**
25280

- Remove/Replace IPR without Damaging the Connector
- Applications: Ford 6.0 L and Other Diesel Engines



Oxygen Sensor Socket Set

SKU 1103591 **27⁹⁹**
37110

- Special Purpose, Universal Slotted Socket That Services Hex Vacuum Switches and Oxygen Sensors
- Includes Sockets for Most Applications:
 - 3/8" Drive 7/8" (22 mm) Deep
 - 3/8" Drive 7/8" (22 mm) Crowfoot
 - 1/2" Drive 7/8" (22 mm) Deep Crowfoot



22 mm Oxygen Sensor Wrench

SKU 947305 **29⁹⁹**
33625246

- Use with Oxygen Sensors on Ford 4.6 and 5.4 Engines 7/8" (22 mm) Used in SUVs and Light Trucks
- Swivel Head for Maneuverability
- Chrome Vanadium Steel for Toughness
- Posi-Grip Wrenching System for Greater Applied Torque
- Chrome Plating for Easy Cleanup



7 Piece Sensor Socket Set

SKU 900823 **61⁹⁹**
27189

- Used for Oil Pressure Switches, Oil Pressure Sending Units and Thermal Sensor Switches
- Includes: 7/8" (22 mm) Offset Extended Oxygen Sensor, 7/8" (22 mm) Offset Oxygen Sensor Socket, 7/8" (22 mm) Vacuum Switch Socket, 7/8" (22 mm) Oxygen Sensor Socket, 1-1/16" (27 mm) Deep Oil Switch Socket, 1-3/16" (29 mm) Oil Sender Unit Socket and 1-1/16" (27 mm) GM Thermal Sensor Switch Socket
- Chrome Vanadium for Toughness



OEM TOOLS

Remote Starters

Heavy Duty Remote Starter Switch

SKU 265127 **24⁹⁹**
25331

- 63" (160 cm) Heavy Insulated Wire for Long Tool Life
- Heavy Duty Insulated Alligator Clips
- Rugged Rubber Housing
- Switch Amps: 30A @ 6V and 12V; 15A @ 24V
- Weight: 9.5 Oz.



Remote Starter Switch

SKU 265124 **26⁹⁹**
25330

- Heavy Clips with Insulated Sleeves Attach to Ground and Starter Solenoid Switch Thumb Activated Switch 83" Heavy Insulated Wire for Long Tool Life



Insulated Tools

10 Piece Insulated Screwdriver Set

SKU 1267942 **59⁹⁹**
22593

- 1,000V VDE Certified Insulated Screwdrivers
- Insulated Grip Handle and Precision Handle for Added Efficiency
- Insulation Sculpted Directly Onto Blade for Permanent Bonding
- Quick-Release Mechanism for Effortless Blade Change
- Exchangeable Blades with a Slim Tip to Fit Tight Terminal Blocks
- Durable Tool Pouch Included for Easy Organization
- Includes: 4 Slotted Blades



OEM TOOLS

SPECIALTY TOOLS

Fuel Pump Tools

Fuel Tank Adapter

SKU 1407554 **219⁹⁹**
24832

- Makes Fuel Tank Removal Safe and Easy
- Works with Most Transmission Jacks
- Includes: 2 Nylon Straps to Secure Tank
- Foam Rubber Pads Protect Tank

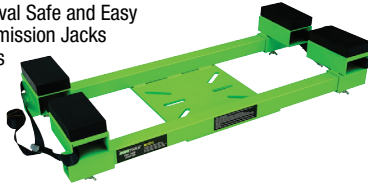

OEM TOOLS®

Bed Lifter

SKU OSB **340⁹⁹**
STK35885

- Designed to Lift Truck Beds Safely and Easily
- Lifting Brackets Adjusts to Evenly Distribute Weight



For OSB, Call 901-300-4878

STECK
Innovative auto/body tools and equipment

OEM TOOLS®

Fuel Tank Lock Ring Tool

SKU 751721 **39⁹⁹**
24398

- Ford F150 Trucks (2004 - Newer); Chrysler/Dodge Mini-Vans, PT Cruiser, Dakota, Durango (2004 - Newer); Chevy 1/2 Ton and 3/4 Ton Trucks (2004 - Newer)
- Works with 1/2" Drive Ratchet or Breaker Bar

Fuel Pump Module Spanner Wrench

SKU 110278 **29⁹⁹**
25156

- Removes and Installs the Fuel Pump Retaining Ring



OEM TOOLS®

Adjustable Multi-Arm Lock Ring Tool

SKU 1491306 **34⁹⁹**
25558

- Interchangeable Arms to Remove and Install the Retaining Ring on the Fuel Pump Module
- Adjustable Arms to Easily Adjust to the Fitment of the Retaining and Locking Rings
- Slip Resistant Spanner to Limit Damage to the Lock Ring and Retaining Ring
- 3/8" Square Drive



OEM TOOLS®



Throttle Depressors

Brake - Accelerator Pedal Depressor

SKU 802194 **42⁹⁹**
24232

- Holds Brake or Accelerator Pedal at Desired Position
- Easy to Adjust
- Extends to 24"
- Suitable for Many Diagnostic Applications



OEM TOOLS®

Steering Wheel Holder and Pedal Depressor Set

SKU 802195 **99⁹⁹**
24231

- Holds Steering Wheel in Position for Alignment Adjustments
- Depresses Brake Pedal for Various Brake Checks Including Brake Lamp Operation
- Simply Hand Squeeze the Actuator to Accomplish Fine Adjustments

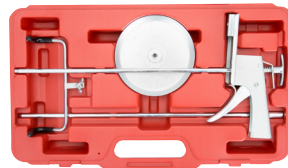

OEM TOOLS®

Throttle Pedal Depressor

SKU 222525 **54⁹⁹**
LIS48700

- Holds Throttle at a Constant RPM
- Engage the Nylon Hook Under the Steering Wheel, Then Extend the Depressor Rod to the Accelerator Pedal
- Length: 40"

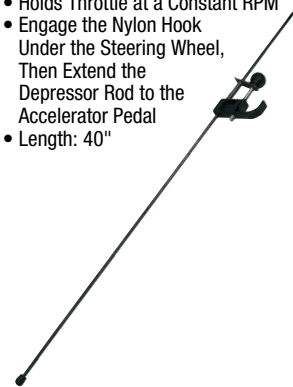

Lisle

Terminal Tools

19 Piece Master Terminal Tool Set

SKU 447159 **129⁹⁹**
27169

- Latest Tools for Coolant Sensors, Wiring Harnesses and Terminal Blocks on Most Modern Vehicles
- Eliminates Potential Damage to Wires or Terminal Blocks
- Application Chart Included Inside Storage Case



OEM TOOLS®

Wire Strippers

9-1/2" Terminal Crimping Pliers with Cutter

SKU OSB **14⁹⁹**
25196

- For Insulated and Non-Insulated Wire Connectors and Terminals
- Specially Hardened Wire Cutter in Nose
- Tapered Nose for Working in Confined Spaces
- For 10 to 22 AWG Wire Connect
- Plastic-Dipped Comfort Handles Minimize Fatigue



For OSB,
Call 901-300-4878

8-1/4" Wire Stripper/Cutter/Crimper/Bolt Cutter

SKU 312821 **20⁹⁹**
25193

- AWG: 10, 12, 14, 16, 20 and 22 Stranded
- AWG: 8, 10, 12, 14, 16 and 18 Solid
- Crimps 7 and 8 mm Ignition Terminals

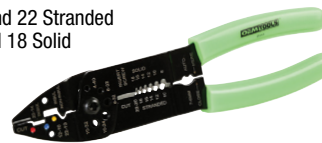

7" Wire Stripper Crimper - Cutter

SKU 751657 **21⁹⁹**
24452

- Strips 20-12 Gauge Insulated and Non-Insulated Wire
- Use for Wire Cutting and Stripping, as Pliers for Grabbing and Twisting or for Crimping of Insulated and Non-Insulated Connectors
- Industrial Finish with Red Textured Grips



6-in-1 Long Nose Pliers

SKU 177785 **29⁹⁹**
22631

- Wire Strippers: 10, 12, 14, 16, 18, 20, 22 AWG
- Wire Crimper: 10 - 20 AWG
- Ergonomic Pistol Grip for Added Leverage
- Ideal for Hard-to-Reach Spot



OEM TOOLS®

6" Wire Stripper

SKU OSB **39⁹⁹**
25191

- Precision Ground Jaws
- 10 to 22 AWG Spring Loaded with Built-in Lock Cushioned Grip Handles



For OSB, Call 901-300-4878

SPECIALTY TOOLS

TO ORDER, contact your Commercial Sales Manager or go to AutoZonePro.com

SPECIALTY TOOLS

PowerProbe

ECT3000 Electrical Circuit Tracer

SKU 1392338 **194⁹⁹**
PWPECT3000B

- Automatic and Manual Sensitivity Locking
- Arrow Indicates Direction to Short
- Signal Distance Indicator Bar
- 10 Minute Auto Shut Off
- Ergonomic Housing



Memory Saver/Parasitic Drain Monitor

SKU 1580963 **259⁹⁹**
PWPPDRAW



- Connects Via 16Pin OBDII Port and Supplies Power and Monitors the Vehicles Electrical System for Parasitic Draw
- View and Record Data Via Bluetooth on Power Probe Link App
- Graphing Mode for Displaying Voltage and Amperage as a Wave Form
- Readings are Displayed on the LCD Screen
- Capable of Delivery Up to 10 Amps Continuous Current

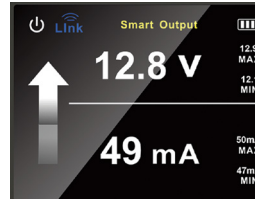

Circuit Testers

Coiled Cord Circuit Tester

SKU 422468 **12⁹⁹**
25886

- Circuit Tester with a Stretchable and Retractable 12' Cord for Long Circuit Runs



One-Handed Wire Piercing Circuit Tester

SKU 422469 **16⁹⁹**
25887

- Bright Hi-Vis 12' Heat and Oil Resistant Coiled Cord
- Molded Strain Relief for Long Life
- Hangs on Wire for Hands-Free Operation
- 6, 12 and 24 Volt Systems



Relay Pliers



Relay Puller Pliers

SKU 291342 **34⁹⁹**
LIS46950

- For Removing Electrical Relays on Most Domestic and Import Vehicles
- Allows Relay to Pop Free from Socket with Less Chance of Damaging the Relay



Heavy Duty Circuit Tester

SKU OSB **34⁹⁹**
25019

- For Testing 6 and 12 Volt Systems for Wire Breaks, Shorts, Fuses, Lamps, Relays, Armatures and More



For OSB, Call 901-300-4878

Digital Display Circuit Tester

SKU 568468 **44⁹⁹**
24451

- Detect Voltage, Power, Ground and Circuit Condition
- Display Provides Precise Voltage
- Voltage: 5 to 30V DC
- Computer Safe - DO NOT Use on Airbags



Voltage Display



60° Electrical Disconnect Pliers

SKU OSB **29⁹⁹**
LIS37980

- Removes Push-Tab Electrical Connectors
- Hook and Point Allow Damage-Free Separation
- Spring Action for One-Handed Use
- Comfortable Dual Durometer Grips

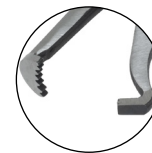

For OSB, Call 901-300-4878

Windshield Tools

Compact Windshield Wiper Arm Puller

SKU 191681 **13⁹⁹**
25319

- Easily Removes Wiper Arms on Most Domestic and Foreign Vehicles
- Will Not Damage Wiper Arm or Hood Cowling During Removal
- Features Turning Knob for Fast Work and Forged Body for Strength
- Compact Design Works Great in Tight Spaces



Universal Wiper Arm Puller

SKU 265136 **39⁹⁹**
25339

- For Pulling Front and Rear Wiper Tight Fitting Wiper Arms
- Suitable for Most Wiper Arms Including Audi, VW, BMW, Ford, Chevrolet, Mercedes-Benz and Others
- Designed to Prevent Damage to Wiper Arm Nozzle



Window Holder Tool

SKU 191670 **14⁹⁹**
25309

- Works on All Cars and Trucks with a Top Door Frame
- Loop Cable Over Door Frame and Attach Suction Cups to Each Side of Glass
- Window Glass is Securely Held Above the Door While Work is Performed



Double Head Suction Cups

SKU 291351 **18⁹⁹**
24246

- Twin Head Suction Cups Help Remove Windshields
- ABS Rubber Cups Grab Hold of Glass
- Flexible Handle Bends to Windshield
- Quick Release Levers for One-Hand Operation



Prices subject to change without notice. Prices do not include applicable taxes, vehicles, tires, rims, installation or optional equipment as shown. Please do not return purchases to the store. For information regarding warranty, repair, or any questions or concerns, call 901-300-4878.

AZG0326

55

SPECIALTY TOOLS

Torque Wrenches

3/8" Drive (10-80 Ft/Lb.)
SKU 177722 **64⁹⁹**
25694

1/2" Drive (10-150 Ft/Lb.)
SKU 012651 **79⁹⁹**
25689

1/2" Drive (25-250 Ft/Lb.)
SKU 177715 **79⁹⁹**
25695

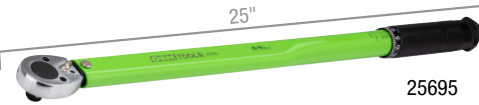

3/8" Drive Torque Wrench (25-250 In/Lb.)

SKU 133657 **52⁹⁹**
25685

- 45 Tooth Round Head Ratchet
- Both Clockwise and Counterclockwise Operation



3/8" Drive Click Style Torque Wrench (10-100 Ft/Lb.)

SKU 133658 **52⁹⁹**
25686

- Precision Torque Control by 45-Tooth Ratchet Head
- Audible Click When Desired Torque is Reached
- Both Clockwise and Counterclockwise Operation
- High Grade Spring Steel Torque Mechanism



3/4" Drive Torque Wrench (50-400 Ft/Lb.)

SKU 1103610 **499⁹⁹**
37309

Ideal for Replacing Ford F150 Front Wheel Bearings

- Range: 50-400 Ft/Lb. and 84.7-559.2 N-m
- Increments 2.5 Ft/Lb.



1/4" Drive Deflection Beam Torque Wrench (80 In/Lb.)

SKU 752621 **21⁹⁹**
25439

- Can Be Used on a Number of Fastening Applications Including Boats, Cars, Motorcycles and Bikes
- 80 In/Lb. (0-9 Nm) in Maximum Working Torque Dual Range Scale Features In/Lb. and Newton Meter Measurement
- Delivers Accurate Measurements When Used Clockwise or Counterclockwise
- Hard-Spring Steel Beam Resists Bending to Deliver Precise Readings



1/2" Drive Click Style Torque Wrench (25-250 Ft/Lb.)

SKU 133659 **89⁹⁹**
25687

- Both Clockwise and Counterclockwise Operation

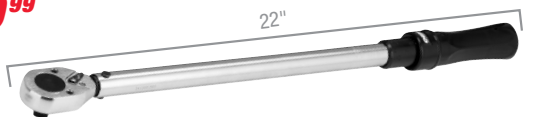

3/4" Drive Professional Micrometer Torque Wrench (100-600 Ft/Lb.)

SKU 217376 **369⁹⁹**
25688

- Right Hand Direction

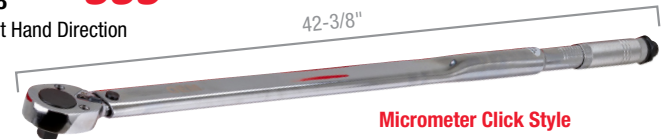

Micrometer Click Style

Measuring Tools

Tire Tread Depth Gauge

SKU 954233 **49⁹⁹**
CEN3S402A

- Easy-to-Read Digital Display
- Fractional Scale in 1/32" Increments
- Spring-Loaded Plunger



Central TOOLS, Inc.
QUALITY AND INNOVATION SINCE 1988

24" Straight Edge

SKU 949552 **49⁹⁹**
25355

- Constructed with 1/4" Thick Cold Rolled Steel
- Durable Powder Coat Finish with Precision Ground Edge
- Hang Hole for Convenient Storage
- Includes Reusable Protective Edge

OEM TOOLS[®]



OEM TOOLS[®]
MADE IN U.S.A.

1" Dial Indicator Set

SKU 954195 **99⁹⁹**
CEN3D101

- Strong Magnetic Base
- Revolution Counter
- Full 1" Range



Central TOOLS, Inc.
QUALITY AND INNOVATION SINCE 1988

Indicator Set with Flex Arms and Lock Pliers

SKU 954184 **149⁹⁹**
CEN3D103

- Locking Pliers for Mounting
- Flex Arm for Extra Reach
- Revolution Counter
- Full 1" Range



Central TOOLS, Inc.
QUALITY AND INNOVATION SINCE 1988

Extended Range Bore Gauge

SKU 954188 **244⁹⁹**
CEN3D302

- Extended Range of 1.4" to 6"
- Lower Range for Small Applications
- Reach Deep into Cylinders



Central TOOLS, Inc.
QUALITY AND INNOVATION SINCE 1988

0-5.5" Digital Rotor Gauge

SKU 954197 **109⁹⁹**
CEN3M430A

- Easy-to-Read Digital Display
- Pointed Anvil for Measuring Grooves
- Inch and Metric Readings



Central TOOLS, Inc.
QUALITY AND INNOVATION SINCE 1988

Digital Drum Gauge

SKU 954196 **289⁹⁹**
CEN3B531

- Depth Stops to Improve Accuracy
- Pointed Anvils for Grooves
- Easy-to-Read Digital Display
- 4" to 20" Range Plus Oversize



Central TOOLS, Inc.
QUALITY AND INNOVATION SINCE 1988

6" Electronic Digital Caliper

SKU 864649 **24⁹⁹**
25363

- Large Easy to Read LCD Display
- Zeroing Feature
- Thumb Roller with Locking Device



OEM TOOLS[®]

SPECIALTY TOOLS

TO ORDER, contact your Commercial Sales Manager or go to AutoZonePro.com

SPECIALTY TOOLS

Steck - Lockout Tools

BigEasy™ Glo with Easy Wedge Lockout Kit

SKU 964494 **89⁹⁹**
STK32955

- Glow-In-The-Dark Yellow Allows You to See the Tool at Night or Through Tinted Windows
- Easy Wedge Offers Controlled Opening of the Car Door for Inserting the BigEasy Glo



Glows in the Dark

BigEasy™ Carrying Case

SKU 227873 **39⁹⁹**
STK32935



- Made of Soft, Yet Firm Material to Protect Your BigEasy Kit
- Custom Pockets for the BigEasy, Non-Marring Wedge, Lock Knob Lifter and Easy Wedge
- Makes it Convenient to Stow Your BigEasy Kit in Your Truck



BigEasy™ Lockout Kit

SKU 964491 **44⁹⁹**
STK32900

- High Visibility Pink Powder Coating and Improved Non-Marring Wedge
- Lock Knob Lifter for Cars with Flat Lock Knobs at the Top of the Door
- Paint Protector Reduces Friction Between the Car Door and the BigEasy

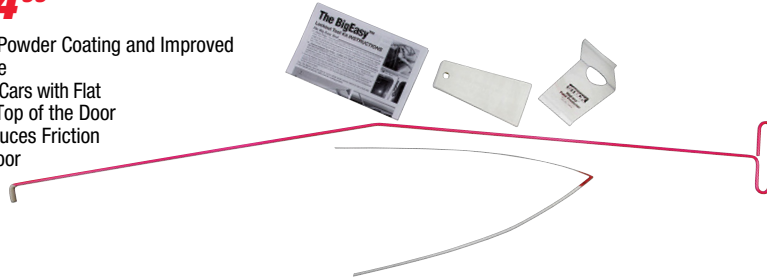

BigEasy™ Easy Wedge (Inflatable)

SKU 964493 **39⁹⁹**
STK32922

- Inflatable Controlled Opening of Car Door for Insertion of the BigEasy™



Access Tools - Lockout Tools

Emergency Response Kit Long Case

SKU 1339730 **169⁹⁹**
AETERKLC

- Most Popular Accessories, Gets into Any Vehicle
- Designed by First Responders
- Emergency Ready
- Includes: Quick Max Long Reach Tool, Flex Max, Button Master, Super One Hand Jack Tool, Super Air Wedge, Glassman Wedge and Button Strip Tool

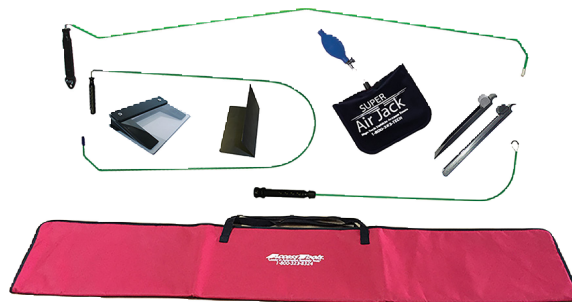

Button Master

SKU 1189051 **54⁹⁹**
AETRCBM

- Flexible Coated Long Reach Tool
- Retractable Loop with Grip Cover
- Grab Vertical Door Buttons with Ease
- Approximately 38" in Length When Straightened
- Most Flexible and Versatile Version of All the Button Masters



One Hand Jack Set

SKU 1145698 **144⁹⁹**
AETOHJS4

- Easy-to-Use Car Opening Kit
- Soft Shielded Long Reach Tool That Won't Scratch Paint
- Air Wedge with Stiff Insert for Easy Insertion
- Vertical Button Tool One Hand Jack for Quick, Damage-Free Insertion of the Air Jack



Rivet Tools



Rivet Tool Kit

SKU 94877 **143⁹⁹**
MAR39001KIT

- 50 each: SB4-2, SB4-4, AB4-2A
- 25 each: SC4-4, AB6-2



Rivet Tool

SKU OSB **93⁹⁹**
MAR39000HP2

For OSB, Call 901-300-4878

KLIK-LOK Plastic Rivet Setter

SKU 222531 **68⁹⁹**
MAR48005

- Includes a Universal Nosepiece that Sets All Plastic Rivets



Big Daddy® Hand Riveter

SKU 094886 **294⁹⁹**
MAR39031

Sets Large Diameter Blind Rivets.

- Double Gear Reduction System Easily Sets from 1/8" to 1/4" Diameter Klik-Fast Rivets in All Alloys Including 1/4" Klik-Split® Rivets
- Comes with 5/32", 3/16" and 1/4" Nose Pieces Stored in the Body



Industrial Hand Riveter



SKU 291353 **69⁹⁹**
25921

- For Use with Steel and Aluminum Rivet Noses: 1/8" (3.2 mm), 5/32" (4.0 mm), 3/16" (4.8 mm), 1/4" (6.4 mm)
- Overall Length: 18"
- Maximum Spread: 7"
- Maximum Reach: 5-1/2"
- Long Handle Provides More Leverage



Includes Aluminum Rivet Noses



See More Marson Rivet Tools on AutoZonePro.com

Prices subject to change without notice. Prices do not include applicable taxes, vehicles, tires, rims, installation or optional equipment as shown. Please do not return purchases to the store. For information regarding warranty, repair, or any questions or concerns, call 901-300-4878.

AZG0326

57

SPECIALTY TOOLS

Slide Hammer Pullers

5 Lb. Slide Hammer

SKU 1103572 **59⁹⁹**
37033

- For Use with OEMTOOLS® 27032 Axle Puller, 27058 Inner CV Joint Puller, 27059 Pilot Bearing Puller, and Other Puller Attachments with 5/8" X 18 Threads
- For a Variety of Pulling Tasks
- Chrome Plated Main Shaft
- Thread: 5/8" x 18



9 Way Slide Hammer Puller Set

SKU 1335798 **122⁹⁹**
37191

- Pulls Flange-Type Rear Axles and Most Front Wheel Drive Hubs
- Internal and External Jaws Provide a Variety of Combinations to Pull Bearings, Gears and Seals
- 2-Way and 3-Way Cross Blocks
- Includes: Grip Wrench Adapter and Dent Puller Attachment
- Designed for Use with Other 5/8" x 18 Thread Slide Hammer Attachments

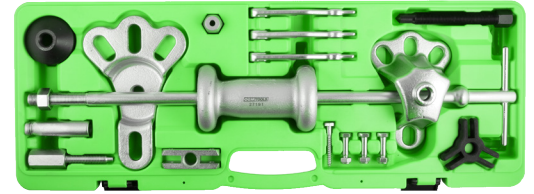

OEM TOOLS®

Rear Axle Puller Set

SKU 094801 **119⁹⁹**
27202

- Use for Flange-Type Rear Axle and Bearing Removal on Most Late Model Passenger Cars and Light Trucks
- Slide Rod and Adapters are 5/8" x 18 Standard Threads

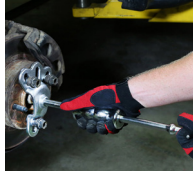

VW/Audi Fuel Injector Puller Kit

SKU 1103636 **64⁹⁹**
37383

- Includes: 1 Mini Slide Hammer, 1 Installation Tool, 2 Special Puller Attachments and 3 Knurled Collars
- Comes in a Sturdy Blow Mold Case
- Used with All 2.0 L TSI/FSI/TSFI Engines



Multi-Purpose Puller

Multi-Purpose Bearing and Pulley Puller Set

SKU 900824 **174⁹⁹**
27190

- Use on Pitman Arms, Timing Gears, Carrier Side Bearings, Crankshaft Pulleys and More
- 20 Piece Set Includes: 6 Jaws, 2 Bar Housings, 6 Bolts and 2 Retainers
- Capacity: 6-10 Tons (Depending on the Jaws)
- Combine to Create 10 Different Pullers



OEM TOOLS®

Retainer Remover

Brake Cylinder Retainer Remover

SKU 265111 **17⁹⁹**
25268

- Expands and Holds Special Retainer So the Brake Cylinder May Be Removed
- Releases the Spring Clip Retainer That Attaches the Rear Brake Cylinder to Backing Plate



OEM TOOLS®

Lock and Snap Ring Pliers

Professional Internal/External Snap Ring Pliers

SKU 1340233 **22⁹⁹**
25097

- Unique Jaw Design Makes it Easy to Switch from Internal to External Configurations
- For Both Internal and External Rings
- Alloy Steel and PVC Grip with Storage for Tips
- Includes: 3 Pairs of Tips and Hex Key, 1 Pair Straight Tips for 1.2 mm and 1.8 mm, 2 Pair 90° Tips for 1.2 mm and 1.8 mm



Angle Tip Lock Ring Pliers

SKU 191055 **19⁹⁹**
25354

- For Spreading Snap Rings Found on Brakes, Pedal Shafts, Clutch Shafts, Transmissions, Machine Tools and Piston Rings
- Constructed with Durable Drop Forged Steel Alloy
- Spring-Loaded Jaws Feature a Scored Outside Edge for a Secure Grip
- Vinyl Grip Handles for Added Comfort and Control
- Spread: 3/4"
- Length: 8-1/4"



10 Piece Snap Ring Pliers Set

SKU 900819 **114⁹⁹**
27180

- Includes: (2) 5-1/2" Bent Pliers (0.038" and 0.047" Tip), (2) 6" Straight Pliers (0.038" and 0.047" Tip), 7-1/2" Bent Pliers (0.070" Tip), 8" Straight Pliers (0.070" Tip), 8-1/2" Bent Pliers (0.090" Tip), 9" Straight Pliers (0.090" Tip), 1 Pick Tool and 1 Hook Tool
- For Both Internal and External Rings
- Constructed with Heat-Treated Chrome Moly Steel
- Comes in Sturdy Blow Mold Case

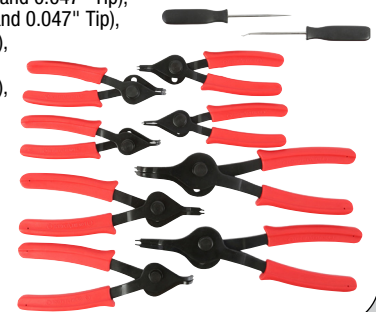

OEM TOOLS®

Jaw Pullers

- Adjustable and Reversible Jaws with 2 and 3 Jaw Configurations Available
- Remove Gears, Pulleys and Other Components in Various Applications, from Automotive to Heavy Duty Vehicles and Equipment
- Heavy Duty Forged Construction with Chrome and Black Oxide Finishes Protect Against Corrosion

SKU	Part #	Capacity	Jaw	Spread	Reach	Price
246386	25902	1 Ton	2/3 Jaw	3"	3-1/4"	29.99
70134	25901	2 Ton	2/3 Jaw	6"	4-3/4"	38.99
141513	25914	5 Ton	2 Jaw	6"	3-1/4"	30.99
291357	25920	5 Ton	3 Jaw	6-1/4"	5-1/2"	33.99
231202	25919	5 Ton	2/3 Jaw	7"	5-1/2"	43.99



25901



OEM TOOLS®

Cam/Crankshaft Tools

6 Piece Crank Bolt Socket Set

SKU 919501
25276 **124⁹⁹**

- Includes: 17, 19, 21, 22, 26 and 27 mm Deep Counter-Weighted Sockets



Crank Bolt Sockets

Deep Counter-Weighted Sockets Provide Increased Torque to Break Loose Stubborn Crank Bolts



- Applications: Honda-Acura, Models: Accord, Civic, Pilot, CRV, Odyssey, CL TL Integra, MDX, Vehicles. Plus Toyota-Lexus, Models: Camry, Corolla, 4Runner, Sequoia, ES300, LS400 Vehicles and More
- Constructed with Durable Chrome Moly Steel
- Provides Increased Torque to Break Loose Stubborn Crank Bolts

17 mm
SKU 912348
25275 **19⁹⁹**

19 mm
SKU 1335801
25290 **19⁹⁹**

21 mm
SKU 912343
25273 **19⁹⁹**

22 mm
SKU OSB
25300 **19⁹⁹**

26 mm
SKU 919500
25278 **19⁹⁹**

27 mm
SKU 919497
25279 **19⁹⁹**

For OSB, Call 901-300-4878

Universal Pulley and Fan Clutch Holder



SKU 547013
27281 **94⁹⁹**

- Fits Many Different Fan Clutches, Cam and Crank Pulleys with Slots or Holes Adjustable Diameter: 1-1/2" to 8-5/8" Pin Sizes: 6-10 mm, 8-11 mm, 10-12 mm and 11-16 mm
- Comes in Blow Mold Case

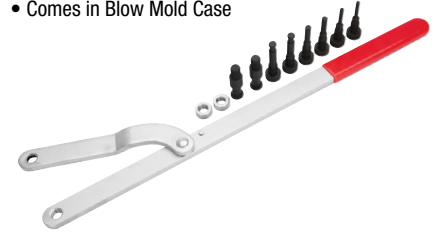

5 Piece Master Cam/Timing Gear Clamp Set



SKU 383452
27210 **32⁹⁹**

- Covers Most Single, Twin Cam and Quad Cam Engines
- Locks Camshaft to Hold Valve Timing During Timing Belt Replacement



Ford Cam Tool 1.6 Liter



SKU 1103640
37380 **22⁹⁹**

- Designed to Hold the VCT Sprockets in Position During Timing Belt Installation or Camshaft Service
- Alignment Tool Services: Ford Fiesta (2011 to 2014), Ford Escape (2013 to 2014), Ford Fusion (2013 to 2014), Ford Transit (2013 to 2014)



Ford 2.0 L, 2.3 L, 2.5 L Cam Tool Kit



SKU 626108
24448 **23⁹⁹**

- Applications: 2.0 L DOHC Engines Found in Ford and Mercury (1994 to 2003), 2.5 L DOHC, 2.3 L DOHC 4V and 2.0 L DOHC Engines in Ford, Mercury and Mazda (2004 to 2012) and 2.0 L DOHC Engines in Ford Probe (1993 to 1994)



Ford Timing Chain Locking Wedge Tool



SKU 012647
24207 **11⁹⁹**

- For 2005-14 5.4 L and 4.6 L 3V OE Type Tool Allows for Easy Cam Changes without Removing the Timing Cover
- Compact and Easy to Use
- OE Type Tool
- For 5.4 L and 4.6 L 3V (2005-2014)



DOHC Cam Lock Holder



SKU 291419
LIS36880 **59⁹⁹**

- This Versatile Tool Easily Locks and Holds Both Camshaft Sprockets Firmly in Place
- Preserves the Engine Timing During Belt or Chain Replacement



Pilot Bearing Puller



SKU 775523
25089 **30⁹⁹**

- Use to Pull Pilot Bearing from End of Crankshaft
- Plate Prevents the Jaws from Spinning When Force is Applied
- Spread Range: 1/2" to 1-1/2"
- Reach Range: 3/16" to 11/4"



Pilot Bearing Puller Attachment



SKU 1368778
27059 **19⁹⁹**

- Use with OEMTOOLS 37033 and 27202 Slide Hammer Pullers
- Threaded with Both 5/8" x 18 and 3/4" x 16 Threads to Fit Most Slide Hammers



Ford Master Timing Kit



SKU OSB
CTA2221 **284⁹⁹**

- Includes: Harmonic Balancer Holder, Camshaft Alignment Tool, VCT Alignment Tool, Crankshaft Positioning Tool, Crankshaft Vibration Dampener Alignment Tool, 3 Pc. Wedges and Camshaft Timing Kit
- Serves Ford, Mazda and Lincoln 1.4 L, 1.5 L, 1.6 L, 2.0 L, 2.3 L, 2.5 L, 3.0 L and 3.5 L Engines

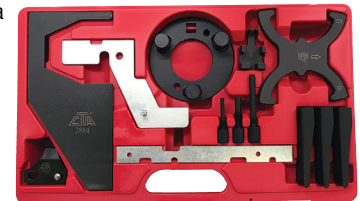

For OSB, Call 901-300-4878

Flywheel Turner



SKU 1207891
25556 **19⁹⁹**

- Holds Flex Plates and Fly Wheels to Allow Clutch, Transmission and Crankshaft Service
- Spring Tensioned to Keep the Wrench Securely Engaged
- Sure Grip Handle



3.5 L and 3.7 L Camshaft Holding Tool Set



SKU OSB
44889 **39⁹⁹**

- Kit Contains Everything Required to Perform Timing Service on 3.5L EcoBoost Engines
- Also Services Select 3.5L Duratec (Non-Turbo), 2.7L, and 3.7L Engines, Various Models 2007-2023
- Comparable to Ford Factory Tools: 303-1248, 303-1530, and 303-1655
- 2 Timing Bracket Sets Hold 1st and 2nd Generation EcoBoost Cams

For OSB, Call 901-300-4878



NEW

Universal Camshaft Bearing Tool



SKU 191677
27143 **239⁹⁹**

- Removes or Inserts Camshaft Bearings in Nearly All Engines
- Set Includes: Driving Shaft, Driving Shaft Extension, Expander Unit, 5 Split Driving Plugs, 2 Driving Collars and Centering Cone
- Easy on Bearings
- Range: 1.125" to 2.69"



ENGINE SERVICE

Valve & Cylinder Head Tools

Combustion Leak Detector

OEM TOOLS®

SKU 1103608 **29⁹⁹**
37145

- Test for Internal Combustion Leaks on Gasoline Engines
- Fluid Color Changes to Yellow When a Combustion Leak is Present
- Comes in a Sturdy Blow Mold Case
- Not for Use with Diesel Engines



Combustion Leak Detector Fluid (8 Oz.)

SKU 391381 **9⁰⁰**
25739



STORE STOCKED

Flexible Air Valve Holder

OEM TOOLS®

SKU 1392465 **6⁹⁹**
25029

- For 14 mm and 18 mm Spark Plug Holes
- 14" Flexible Hose Reaches into Tight Areas



Valve Keeper Remover and Installer Kit

Lisle

SKU 011658 **119⁹⁹**
LIS36050

Makes Valve Component Disassembly and Reassembly Fast and Easy

- For Use with Valve Stems from 4.5 to 7.5 mm and 5/16" to 3/8"
- Magnet in Tool Body Captures Keepers
- Smaller Size Works on Toyota 4 Cylinder and Chrysler New World Engine



Hydraulic Valve Lifter Puller

OEM TOOLS®

SKU 424904 **24⁹⁹**
27146

- Use for Removing Many Valve Lifters from Engine Block



Ford Valve Spring Compressor

OEM TOOLS®

SKU 626111 **24⁹⁹**
24434

- Applications: 1991 to 2004 Ford Vehicles with 4.6 L, 2V, V8 Engines; 4.6 4V, 5.4 V8 and 6.8 V10
- Works with Engine Removed or Installed, Cylinder Head On or Off
- Not for Triton 5.4 3V



Lever Valve Spring Compressor

OEM TOOLS®

SKU 662780 **83⁹⁹**
24676

- Lever Action Stays Compressed for Easy Valve Lock Removal
- Included Adapters Fit Valve Retainer Diameters from 1" (25 mm) to 1-3/16" (30 mm)
- Compression Range from 1-3/8" to 5-5/8" (35 mm to 142 mm)



Valve Spring Compressor

OEM TOOLS®

SKU 552331 **11⁹⁹**
25064

- Compresses Valve Springs on GM V8 Engines with Stud-Type Rocker Arms without Having to Remove Cylinder Heads
- Use with OEMTOOLS® 25029



Ford Valve Spring Compressor for 3-Valve Engines

OEM TOOLS®

SKU 814391 **24⁹⁹**
24429

- Designed to Compress the Valve Spring without Removing the Camshaft While Servicing the Cylinder Head in Ford 3-Valve Engines
- For Use with Ford 3-Valve 4.6 L and 5.4 L Engines



Push Rod Remover

OEM TOOLS®

SKU 459100 **29⁹⁹**
LIS48300

- Redesigned for Newer 3.5 L and 3.6 L GM Engines - Also Works on GM V6 2.8L, 3.1 L and 3.4L
- Quickly Removes Push Rods to Replace the Intake Gaskets without Removing Rocker Arms



Torque Adapter, Diesel Head Bolt, Ford 6.0 L Power Stroke® Engines

OEM TOOLS®

SKU 298191 **16⁹⁹**
24208

- Eliminates the Need to Remove the Truck/Van Cab from the Chassis to Access the Rear Head Bolts
- Eliminates the Need to Remove the Evaporator Housing, Saving 2 Hours of Time and the Additional Cost of Refrigerant Added During A/C Recharging
- Prevents Damage to the Rear Heat Shield
- Use with OEMTOOLS® 27309 3/4" Drive Torque Wrench and OEMTOOLS® 22398 18 mm Socket



24" Straight Edge

OEM TOOLS®

SKU 949552 **49⁹⁹**
25355

- Use with a Feeler Gauge to Inspect for Distortion on Engine Blocks, Cylinder Heads, Fly Wheels, Main Bearing Saddles, Cam Bearing Saddles, Cam Covers and Bell Housings
- Constructed with 1/4" Thick Cold Rolled Steel
- Precision Ground Edge to +/- 0.001"
- Durable Powder-Coat Finish
- Hang Hole for Convenient Storage
- Includes: Reusable Protective Edge



Engine Cylinder Hones

BC 180SC Flex-Hone Tool Kit

SKU 213154 **269⁹⁹**
BRM14353

- 10 Piece Kit Features Flex-Hone Sizes: 10 mm, 1/2", 5/8", 3/4", 7/8", 1", 1-1/4", 1-1/2", 1-3/4" and 2"
- Complimentary Snap Back Hat and 1/2 Pint of Flex-Hone Oil



BRM

Adjustable Engine Cylinder Hone Deglazer

OEM TOOLS®

SKU 532002 **39⁹⁹**
25041

- Range: 2" to 7" (51 mm to 128 mm)
- Spring Tension Adjusting Nut for Positive Cutting Action at All Speeds
- Includes: 4" Medium Grit Stones



SKU	Part #	Product	Cylinder Diameter		Price
			Metric	SAE	
341226	BRMBC30018	Flex-Hone™ GB	76 mm	3"	54.99
341232	BRMGB31412	Flex-Hone™ GB	83 mm	3-1/4"	61.99
341239	BRMGB31212	Flex-Hone™ GB	89 mm	3-1/2"	66.99
341317	BRMGB33412	Flex-Hone™ GB	95 mm	3-3/4"	71.99
341325	BRMGB41812	Flex-Hone™ GB	105 mm	4-1/8"	76.99
341332	BRMGB45812	Flex-Hone™ GB	118 mm	4-5/8"	85.99

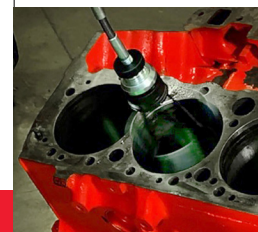

ADDITIONAL SIZES AVAILABLE - CALL US AT 901-300-4878 OR VISIT AZTOOL1.COM

Prices subject to change without notice. Prices do not include applicable taxes, vehicles, tires, rims, installation or optional equipment as shown. Please do not return purchases to the store. For information regarding warranty, repair, or any questions or concerns, call 901-300-4878.

Harmonic Balancer Tools

Harmonic Balancer/Steering Wheel Puller

SKU 532440 **28⁹⁹**
25053

- Removes Balancers, Steering Wheels, Pulleys and/or Gears with Tapped Holes
- Floating Swivel Helps Prevent Damage to Shaft End
- Includes: 5/16"-18 x 2" Bolts, 5/16"-18 x 2" Bolts, M8-1.25 x 80 mm Metric Bolts, 3/8"-16 x 4" Bolts
- Heat Treated Yoke Forged from High-Strength Alloy Steel



Harmonic Balancer Puller

SKU OSB **49⁹⁹**
25057

- 2 and 3 Jaw Configuration for Use with 3, 4 and 6 Spoke Harmonic Balancers
- Angled Jaw Grips Harmonic Balancers Found on Gen 3 Coyote Engines as Well as Harmonic Balancers Found on Some Ford 7.3L, 3.5L and 2.5L Engines
- Also Ideal for Harmonic Balancers Found on Many 5.7L Dodge/Ram Hemi Engines



For OSB, Call 901-300-4878

GM Harmonic Balancer Puller

OEM TOOLS

SKU 213102 **53⁹⁹**
25264

- **Time Saving Tool, No Need to Remove Radiator**
- Designed to Remove Harmonic Balancers without Tapped Holes
- GM Applications: 5.3 L, 5.7 LS1, 6.0 LS2, 6.2 LS3, 7.0 L
- Chrysler/Jeep/Dodge: 3.5 L V6, 3.6 L V6, 4.7 L V8, 5.7 L V8 and 6.1 L V8



Universal Pulley and Fan Clutch Holder

SKU 547013 **94⁹⁹**
27281

- Fits Many Different Fan Clutches, Cam and Crank Pulleys with Slots or Holes
- Adjustable Diameter: 1-1/2" to 8-5/8"
- Pin Sizes: 6-10 mm, 8-11 mm, 10-12 mm and 11-16 mm
- Comes in Blow Mold Case



Harmonic Balancer Installer

SKU 1103603 **41⁹⁹**
37144

- Use to Properly Install Harmonic Balancers without Damage
- Thread Adapters: 12 mm x 1.5, 14 mm x 1.5, 16 mm x 2.0, 7/16" x 20, 1/2" x 20, 9/16" x 18, 5/8" x 18 and 3/4" x 16

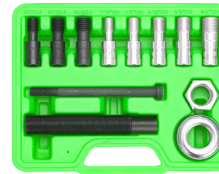

Honda/Acura Crank Damper Holder Tool

SKU 1069101 **16⁹⁹**
26507

- For Removal and Installation of the Crank Bolt on Honda/Acura Engines (1990 - Newer)
- Designed to Hold Crankshaft Pulley to Install/Remove Crankshaft Pulley Bolt
- 50 mm Hex
- 1/2" Drive Works with Ratchet or Breaker Bar



Harmonic Balancer Puller Kit

SKU 818738 **42⁹⁹**
25090

Unique Jaw and Returning Springs for Easy Positioning of the Puller

- Includes: Puller Body, 3 Jaw Puller, 3 Jaw Retaining Pins, 3 Wave Washers, Pressure Screw
- Insert Rods: 4", 5-13/32", 6-1/2" and 7-13/32"
- Used on Many GM, Ford, Mitsubishi and Chrysler Engines



Harmonic Balancer Puller

SKU 1103576 **31⁹⁹**
37187

- Includes: Yoke, Pressure Screw and Pulling Screws
- Floating Swivel Prevents Damage to Shaft Ends
- Ideal for Any Shop or Garage
- Pulling Balancers and More
- Heat-Treated for Strength and Durability



Long Reach Harmonic Balancer/Pulley Installer for GM, Ford and Chrysler

SKU 1103550 **36⁹⁹**
37306

- Use to Install Crank Pulley or Underdrive Pulley on Many Late Model Ford, GM, Dodge and Chrysler Vehicles with V8 and V6 Engines
- Includes: M16 x 2.0 mm (GM), M14 x 1.5 mm (Dodge, Chrysler and Jeep), M12 x 1.75 mm (Dodge Chrysler and Jeep) and M12 x 1.5 mm (Ford)

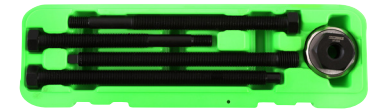

Hex Oil Pump Primers

- Used to Prime the Lubricating System of a Rebuilt Engine Prior to the First Start, Preventing a Dry Start
- Connects to the Oil Pump Shaft Through the Distributor Hole
- For Use with 3/8" Reversible Drill

OEM TOOLS



Ford 1/4"
SKU 534537 **12⁹⁹**
27061

Ford 5/16"
SKU 534545 **12⁹⁹**
27062



Piston Tools

Piston Ring Compressor

SKU 013641 **24⁹⁹**
24682

- 1-1/2" Deep, Low Friction Wrinkle Band
- Fits 3" to 5" Pistons



Piston Ring Expander Pliers

SKU 003509 **26⁹⁹**
25083

- Eliminates Piston Ring Damage and Distortion During the Installation and Removal Process Dipped Rubber Handles for Improved Grip
- Diameter Range: 3-1/8" (80 mm) to 4-5/8" (120 mm)



OEM TOOLS

Piston Ring Compressors

2-1/2" to 5"
SKU 466487 **21⁹⁹**
25033

- Fits 2-1/2" to 5" Pistons

3-1/2" to 7"
SKU 532069 **24⁹⁹**
25044

- Fits 3-1/2" to 7" Pistons



Flywheel Locking Tool

Flywheel Locking Tool

OEM TOOLS

SKU 1335793 **19⁹⁹**
25557

- Locks Flywheel in Place When Removing Harmonic Balancer on 6.6L Duramax Engines with Allison Automatic Transmissions
- Saves Time by Securing the Flywheel at the Transmission as an Alternative to Removing the Starter for Water Pump Replacement
- Use 36 mm 12 Point Socket with 3/4" Square Drive to Remove Harmonic Balancer Bolt and Retorque on Installation
- Toothed Pieces with Screws Work with Duramax 4500/5500 Trucks



ENGINE SERVICE

Diagnostics

Compression Tester Gauge Set

SKU 1103601 **46⁹⁹**
37138

- Use to Test Compression 0 to 300 psi on 14 mm and 18 mm Spark Plug Ports and Determine Engine Mechanical Condition



8 Piece Noid Light Set

SKU 1103589 **29⁹⁹**
37161

- Includes: GM TBI, GM SCPI, GM PFI, Ford TBI, GEO TBI, Bosch PFI, Bosch Type 2 and GM Multec 2
- See-Through Design to Check Electrical Pulses

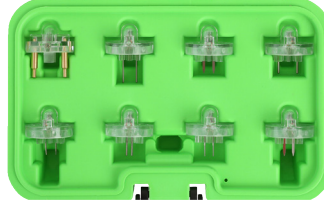

Water Sensor Socket

OEM TOOLS

SKU 607072 **24⁹⁹**
25369

- Used to Remove Water Sensor When Changing the Fuel Filter on GM 6.6L Duramax Diesel Engines 3/8" Square Drive
- GMC 6.6L DuraMax Diesel Engine Application Including Chevy/GMC Pickups (2001 and Newer) and Chevy/GMC Medium Duty Trucks (2003 and Newer)



Master Compression Test Kit

SKU 347236 **174⁹⁹**
27266

- Includes:
 - 2-1/2" Gauge with Dual Scale 0-300 psi and 0-20 Bar
 - 1-1/2" Gauge with Single Scale 0-200 psi
 - 10" Extension with Quick Connect and Protective Boot
 - M14 Hoses: Short Thread and Long Thread
 - M18 Hose with Short Threads
 - M10, M12 and M18 Solid Adapters
 - Extra O-Rings and Valve Cores



Gas Engine Combustion Leak Tester

SKU 1103608 **29⁹⁹**
37145

- Test for Internal Combustion Leaks on Gasoline Engines
- Fluid Color Changes to Yellow When a Combustion Leak is Present
- Designed for Professional Auto Mechanics and Heavy Duty Applications
- Not for Use with Diesel Engines



Use with 25739
Test Fluid Listed
on Page 60

Exhaust Back Pressure Tester/Gauge

SKU 1103604 **84⁹⁹**
37263

- Oxygen Sensor Adapter is M12 and M18 Thread
- 6' Hose Allows User to Test from Driver's Seat
- Test for Restricted Exhaust Systems

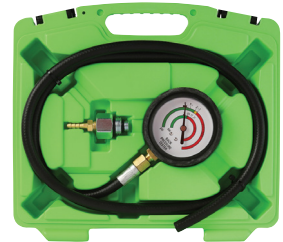

Ford Triton Repair Kits

Ford Triton Plug-Saver® Kit

SKU OSB **268⁹⁹**
MAR98140T

- Designed to Specifically Repair the Spark Plug Ports in 4.6, 5.4 and 6.8 Ford Triton Engines
- Repairs Worn, Damaged Threads
- Includes: Self Cutting Tap, Tool and 8 Inserts in a Sturdy Case



98140T Triton Refill (8 Inserts)

SKU OSB **33⁹⁹**
MAR98149P

For OSB, Call 901-300-4878

marson

Broken Spark Plug Remover Ford Triton 3 Valve

SKU 489173 **134⁹⁹**
LIS65600

- Includes a Unique Porcelain Pusher Tool and a Tapered Left-Hand Thread Remover for Removing the Broken Spark Plug without Leaving the Porcelain in the Engine Cylinder



Lisle

Spark Plug Thread Repair

Spark Plug Thread Repair Kit - Metric M14 - 1.25

SKU 557108 **41⁹⁹**
25643

- Includes: High-Grade Tap, (3) Inserts and a Job-Specific Installation/Tang Break-Off Tool
- Returns Threads to Original Size
- Creates a Permanent and Wear-Resistant Thread



Tapered Seat Spark Plug Thread Repair Kit - Metric M14 - 1.25

SKU 141511 **29⁹⁹**
25647

- 3 Insert Lengths are Provided to Fit the Most Common Spark Plug Reaches
- Positive Mechanical Locking Feature Keeps Insert in Place
- Piloted Reamer Eliminates Need to Drill Out Threads and Ensures Correct Alignment
- Can Be Used to Repair Both Taper Seat and Gasket-Type Spark Plug Assemblies
- Includes: 2-Step Piloted Reamer Tap, 3 Inserts and Swaging Tool



OEM TOOLS

Torque Angle Gauge

1/2" Drive Torque Angle Gauge

SKU OSB **14⁹⁹**
25424

- Easy to Read
- Calibrated in Degrees
- 1/2" Square Drive
- Easy-to-Use Angle Finder
- Accurate Measuring Wheel



For OSB,
Call 901-300-4878

OEM TOOLS

Head Bolt Thread Repair

11 mm x 1.5 D Honda Head Repair Kit

SKU OSB **93⁹⁹**
CTA1420

- Fixes Head Bolt Threads for Honda, Toyota and Other Imports
- Includes: 1 Pc. HSS Drill Bit, 1 Pc. STI Tap, 5 Pc. 1.5D Solid Inserts

For OSB, Call 901-300-4878



NEW

CTA

STOP the Knock!

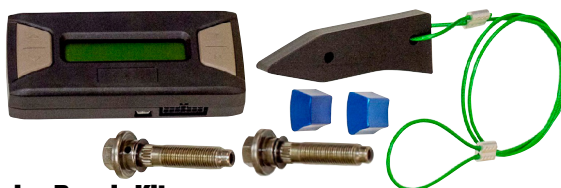

Cam Phaser Noise Repair Kits Include: Ford Cam Phaser Noise Repair Kit

- Wedge Tool for Easier Installation
- Programmer with OBD-II Cable
- 2 OEM Quality Phaser Bolts
- 2 Lock Outs

SKU 494959 **699⁹⁹**
 LMEF1503V
 • Fits Ford OEM Cam Phaser

This Kit is the Only True, Long Term Repair for Ford Cam Phaser Noise on the Market

Ford, Livernois and logos featured or referred to on this page are the property of their respective trademark holders

Exhaust Tools

Exhaust Manifold Spreader Set

SKU 504028 **33⁹⁹**
 25253TWO

- Use for Reinstalling the Manifold on Small-Block Chevrolets
- Simple Way to Expand Warped Manifold to Align Bolt Holes
- Helps Prevent Cross-Threading of Manifold Bolts
- Works Best When Used in Pairs or Install Before Removing Manifold to Prevent Misalignment



Manifold Drill Template - Ford 2V and 3V

SKU 213145 **89⁹⁹**
 25251

- Designed to Remove Broken Exhaust Manifold Studs
- For Ford Triton 2V and 3V Engines - 4.6L, 5.4 L and 6.8 L V10
- Drill Depth Gauge Marked on Each Adapter
- Interchangeable 2V and 3V Adapters
- Hi-Vis EVA Tray for Easy Storage and Organization
- Includes: Template, 2V Adapter, 3V Adapter, 2 Stud Alignment Pins, 3/16" and 1/8" Double-Sided Drill Bits and Stud Extractor



2-1/8" x 3-7/16" Tailpipe Expander

SKU OSB **149⁹⁹**
 27028

- Expands Tailpipes so Mufflers and Tailpipes Can Be Fitted to the Exhaust System
- Extra-Long Hex Bar for Convenience
- Alloy Steel Construction for Strength and Durability
- Designed for Heavy Duty Applications



1-1/2" to 2-7/16" Tailpipe Expander

SKU OSB **34⁹⁹**
 27027

For OSB, Call 901-300-4878

Fan Clutch Tools

Fan Clutch Wrench Set

SKU 1103596 **99⁹⁹**
 37141

- Works on Many of the Ford, Mazda, Dodge, Lincoln, Mercury and Jeep Makes and Models with the Original Fan Clutch Assembly
- Includes Wrench Sizes: 40 mm, 48 mm, 54 mm, 68 mm, 72 mm, 76 mm and 83 mm



Fan Clutch Holding Tool

SKU 209526 **49⁹⁹**
 27171

- Holds Water Pump Pulley While Servicing Fan Clutch
- Adjustable Jaws Fit Most Water Pump Pulley Bolt Patterns, Including Pressed-On Pulleys
- Jaws Lock in Place



Fan Clutch Service Set for Mercedes-Benz and BMW

SKU 512958 **194⁹⁹**
 27224

- Removes Lock Nuts on Thermo Viscous Fans Found on Mercedes-Benz, BMW and Many Ford Models
- Special Open-Ended Spanner to Allow Removal and Replacement of the Radiator Fan Hub
- The 3-in-1 Design Allows Servicing of 3 Separate Areas of Repair, Eliminating the Need for 3 Different Tools
- Hub Securing Bar - Used for Securing Water Pump Hub from Rotating During R&R of Fan Clutch Nut
- Applicable: Mercedes M103, 104, 111, 119, 120 OM 602, 603, 605, 606; the 10 mm is Used for Adjusting A/C Belt Tension and R&R of Idler Pulley on Models 420, 560 with V-819 (1986 and Newer)
- Applicable: Mercedes M103 (6 CYL, M104 (6 CYL 4 VLV), M119 (8 CYL 4 VLV) M120 (12 CYL 4 VLV)

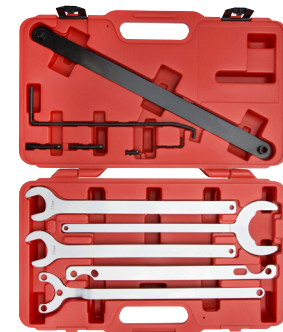

Fan Clutch Wrench Set

SKU 1069095 **29⁹⁹**
 26505

- Use on Ford Model Truck Clutch Fans 1984 to Current
- Wrench Sizes: 36 mm and 57 mm
- Use on 1984 to 1993 Ford 4.9 Liter E and F Series Truck Engines; 2.8 Liter Engines; 1988 to Current 2.9 Liter to 3.0 Liter Engines; 1990 to Current 4.0 Liter Engines



Pneumatic Fan Clutch Wrench Set

SKU 291409 **219⁹⁹**
 LIS43300

- Quickly Removes and Installs Fan Clutch When Repairing the Water Pump or Fan Clutch
- Includes Wrench Sizes: 32 mm, 36 mm, 40 mm; 7/8", 1-7/8" and 2"



Alternator Tools

Alternator Decoupler Pulley Tool Kit

SKU 300124 **24⁹⁹**
 27261

- Works on Both Overriding Alternator Decoupler (OAD) and One-Way Clutch (OWC) Pulleys
- Tools May Be Used While the Alternator is On or Off
- Includes: 2 Pulley Sockets and 3 Shaft Bits
- Comes in a Sturdy Blow Mold Storage Case



Alternator Decoupler Pulley Service Set

SKU 1103629 **47⁹⁹**
 37275

- Removes and Installs Many Alternator Decoupler Pulleys on the Most Popular Vehicles
- Works on Both Overriding Alternator Decoupler (OAD) and One-Way Clutch (OWC) Pulleys



Stretch Belt Tools

Stretch Belt Installation Tool

SKU 227301 **29⁹⁹**
 24363

- Works on Both Large and Small Pulleys
- Clamping Jaw Allows User to Position Serpentine Belt without the Belt Slipping Out of the Tool



Stretch Belt Remove and Installer

SKU 255866 **36⁹⁹**
 LIS59370

- Unique Magnetic Faces Hold the Tool in Place on the Pulley
- Compact, One Piece Tool Can Be Used on the Front or Back Side of the Pulley



CHASSIS & SUSPENSION

Ball Joint Service Kits

XL C-Frame Ball Joint Press Set

SKU 1142924 **157⁹⁹**
25105

- Ideal for Pressing Out Larger Ball Joints on Pick-Up Trucks: Toyota Tacoma and Tundra, Chevrolet 2500-3500 and Tahoe, Dodge Ram 2500-3500 and Ford F350-F550
- Extended C-Frame Allows Use of Multiple Larger Adapters That Standard C-Frame Presses Won't Fit
- C-Frame Constructed with Heavy Duty Forged Steel for Strength and Durability
- For Use with OEMTOOLS® Ball Joint Press Kits and Adapter Sets



Includes
6" and 9"
Pressure
Screws

74 Piece Master Ball Joint Press Kit

SKU 1207895 **999⁹⁹**
37388

- Adapters for Almost Every Car, Van, SUV and Light Duty Truck
- Comprehensive Kit with 70+ Adapters and C-Frame
- Tough Heavy Duty C-Frame is Built to Last
- 2 Heavy Duty Molded Cases are Designed for Storage and Mobility



OEMTOOLS®

Easy to Read
Manual for
Finding
Adapters
Quickly
and Easily



BONUS
VALUE: \$129.99

Hydraulic Ball Joint Separator

25219

With
Purchase of:
37388



Offer Good Through
September 30, 2026

21 Piece Master Ball Joint Press Set

SKU 1142406 **189⁹⁹**
25104

- Removes and Replaces Press-Fit Upper and Lower Ball Joints on 2-Wheel Drive (2WD) and 4-Wheel Drive (4WD) Vehicles
- Includes Adapters with Specialized Cut-Outs to Maneuver Around Obstructions
- Includes Adapters Needed for Removing Upper and Lower Ball Joints on GM, Ford and Chrysler 2WD and 4WD Light-Duty Trucks, Vans and SUVs
- Heavy Duty Forged Steel Alloy C-Frame for the Toughest Jobs — Ideal for Seized Joints



Master Ball Joint Installer/Remover Adapter Set

SKU 1103612 **99⁹⁹**
37310

- Includes All the Receiver Tubes and Removing/Installing Adapters Needed to Work on Many GM, Ford and Chrysler 2 and 4 Wheel Drive Pick-Ups, Vans and SUVs
- Works on Press-Fit Upper and Lower Ball Joints
- For Use with OEMTOOLS® Ball Joint Press Kits and Adapter Sets



Ball/U-Joint Press with 4WD Adapter Set

SKU 1103607 **114⁹⁹**
37089

- Remove and Replace Ball Joints on Many Vehicles
- C-Clamp Frame Press Also Removes and Replaces U-Joints
- Includes Adapters to Service 1/2 to 3/4 Ton 4 Wheel Drive Vehicles Equipped with Dana 44 Series Front Axle



Ball Joint Tools

Ball Joint Separator

SKU 1340232 **35⁹⁹**
37308

- Used for Separating the Ball Joint from the Spindle Support Arm on Domestic and Import FWD Vehicles
- Adjustable for Different Size Ball Joints
- Max. Opening Range: 1-1/8" to 2-1/8"



Low Profile Ball Joint Separator

SKU 1245676 **41⁹⁹**
25112

- Designed for Tight Access Where Many Ball Joint Separators Won't Fit
- For 2005+ Ford, Lincoln and Mercury Applications
- Impact Rated



Polaris ATV Ball Joint Tool

SKU 1142310 **89⁹⁹**
24683

- For Removal and Installation of Upper and Lower Ball Joints on Sportsman XP, RZR and Ranger ATVs



OEMTOOLS®

Hydraulic Ball Joint Separator

SKU 177718 **129⁹⁹**
25219

- Hydraulic Ram Rated to 8 Tons
- Jaw Capacity: 56 mm (2.25")
- Jaw Width: 22 mm (0.86")



Fast. Safe. Efficient.

Ball Joint Separator

SKU 1207880 **20⁹⁹**
26553

- Separate Ball Joints from Spindle Support Arm
- Adjustable for Different Size Ball Joints
- Max. Opening Range: 1-1/8" to 2-1/8"
- Fork Opening Measures 7/8"
- Steel Construction with Black Oxide Pins
- Comes in a Sturdy Blow Mold Case



3/4" Drive Ball Joint Impact Socket

- Used on Chrysler/Dodge Cars, Light Trucks and Vans

2-9/64"

SKU 462494
24215

29⁹⁹



1-59/64"

SKU 662809
24238

29⁹⁹



CHASSIS & SUSPENSION

TO ORDER, contact your Commercial Sales Manager or go to AutoZonePro.com

CHASSIS & SUSPENSION

Spring Compressors

OEM TOOLS®

Floor Mounted Strut Compressor

SKU 1405961 **299⁹⁹**
37037

- 2,200 Lb. Capacity
- Easy-to-Adjust Bracket Conforms to Spring Rate and Diameter
- Handles Spring Coils 3.5" to 8.75" and Up to 5/8" Diameter
- Max. Spring Height: 19"
- Can Be Securely Mounted to the Floor

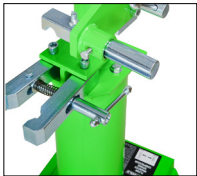

Bracket Design Easily Adjusts to Accommodate a Wide Range of Vehicle Strut Sizes

No Special Adapters Required

Floor Mounting Hardware Not Included

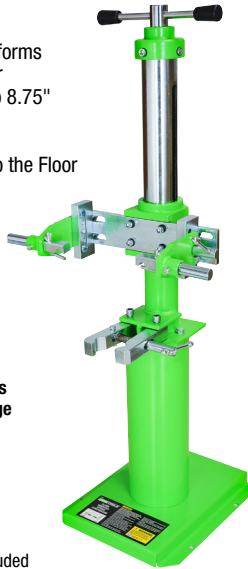

Model 7600 Strut Spring Compressor

SKU 547959 **1,299⁹⁹**
BRA7600

- Handles the Toughest Applications
- Min./Max. Spring Diameters: 3.5"/11.5"
- No Adapters Required

OEM Approved by Major Automakers

Cart for BRA7600

SKU 547960
BRA00-0137 **748⁹⁹**



Mechanical Strut Compressor

SKU OSB
QSPMSC-1000
Call for Price

- Designed to Handle Any Size Spring and Strut Assembly
- Adjustable Extra Strong Clamps for a Perfect Grip
- Top Mounted Tool Tray
- Standard Wall Mount
- Safety Guard Included
- Optional Floor Mount and Third Hand Support Kits



For OSB, Call 901-300-4878

Coil Spring Compressor

SKU 1103643 **89⁹⁹**
37035

- Use to Safely Compress the Coil Spring on Most Cars and Light Trucks
- Can Also Be Used When Installing Coil Spring Spacers

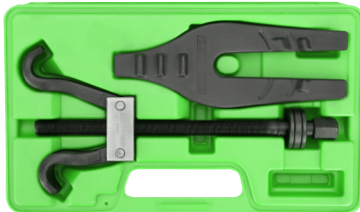

OEM TOOLS®

Coil Spring Compressor Set

SKU 1103614 **39⁹⁹**
37200

- Forged Construction for Strength and Durability
- Removes and Installs Coil Springs Quickly and Safely
- Compresses Coil Springs on Most Passenger Cars and Pickup Trucks

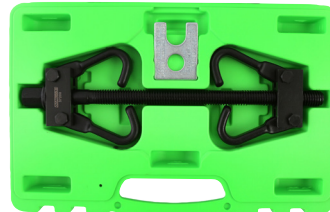

OEM TOOLS®

Strut Spring Compressor

SKU 1207884 **39⁹⁹**
37036

- Used to Compress Strut Springs During Cartridge Replacement
- Safety Latches Lock Spring in Place During Compression Hooks are Forged and Center Screw is Hardened for Longer Life
- Thread Length: 9"
- Can Be Used with Varying Coil Diameters Up to 5/8"

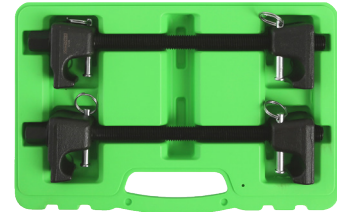

OEM TOOLS®

Suspension

OEM TOOLS®

GM Upper Control Arm Knock Out Tool

SKU 420336 **23⁹⁹**
24210

- Services Chevrolet and GMC 1/2, 3/4 and 1 Ton, 2 and 4 Wheel Drive Trucks (1989 to 2001) and All Wheel Drive Chevrolet Astro and GMC Safari Vans (1990 to 2002)



Shock Socket

OEM TOOLS®

Volvo Shock Retaining Nut Strut Removal Socket Tool

SKU 300125 **20⁹⁹**
24365

- Remove and Install Top Shock Retaining Nut on Volvo Models
- Applications Include: Volvo C70 (1999-2004), Volvo S40 (2000-2004), Volvo S60 (2001-2004), Volvo S70 Non-Turbo (1999-2000), Volvo S70 Turbo (1999-2000), Volvo S70 AWD Turbo (1999-2000), Volvo S80 (1999-2004), Volvo S80 V8 (2007-2008), Volvo S80 Turbo (1999-2006), Volvo V40 (2000-2004), Volvo V70 (1999-2007), Volvo XC90 (2003-2010)



Front End Service Kit

OEM TOOLS®

5 Piece Front End Service Kit

SKU 1267952 **99⁹⁹**
26554

- Large and Small Pitman Arm Puller for Ball Joint Application
- Two Ball Joint Separators
- Three Tie Rod Pullers



Torsion Bar Tool

OEM TOOLS®

GM, Ford, Chrysler Torsion Bar Tool

SKU 1103600 **64⁹⁹**
37278

- Safely Loads and Unloads 5-Lug, 6-Lug and 8-Lug GM, Dodge and Ford Torsion Bar Suspensions for Key Replacement
- Extended Long Reach "C-Clamp" for Use with 2011 and Higher GM Heavy Duty Trucks
- Includes Ford/Dodge Adapter



Prices subject to change without notice. Prices do not include applicable taxes, vehicles, tires, rims, installation or optional equipment as shown. Please do not return purchases to the store. For information regarding warranty, repair, or any questions or concerns, call 901-300-4878.

AZG0326

65

CHASSIS & SUSPENSION

Hub Bearing

Brake Drum and Rotor Puller

SKU 1125878 **139⁹⁹**
25106

- Use on Most FWD and AWD (Some RWD) Vehicles.
- Use with Impact Wrench to Remove Hubs, Drums and Brake Rotors
- Includes 3 Hub Adapters for Use with Most Common Hub Sizes and Types
- Jaw Spread Up to 14" with 5" Reach
- Durable Forged Frame Rated to 7 Tons of Pulling Force for the Toughest Jobs
- Drum and Rotor Pulling Arms Feature with Raised Stops for Use with Ratchet Straps (Not Included)
- Easily Adjust the Arms and Set Puller in Place for Tough Pulling Jobs in Tight Spaces

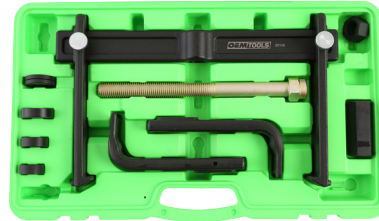
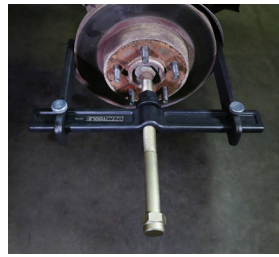
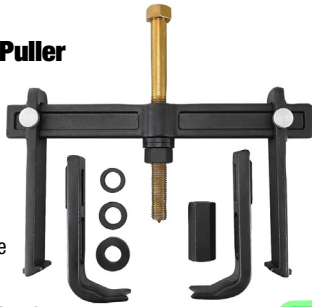

Master Wheel Hub and Bearing Remover and Installer Set

SKU 1103635 **399⁹⁹**
37342

- For Removal and Installation of Front Wheel Hub on Most Vehicles
- Self Centering Design is Incredibly Durable and Easy to Use
- Works on Front, Rear and All-Wheel Drive Vehicles
- Heavy Duty Thrust Bearing Reduces Effort and Extends the Life of the Pressure Screw
- Includes: Adapter Shoes, Pusher Washers, Receiver Sleeves, Nut-Bolt and Heavy Duty Bearing



Wheel Hub Removal Tool

SKU 1245618 **89⁹⁹**
25749

- Ideal For Removing a Frozen Hub Assembly without Damaging the Axle
- For Use on Many Axle Bolted Hubs Including Five, Six and Eight Lug Hubs
- Constructed from High-Quality, Impact-Resistant and Corrosion-Resistant Steel
- 2-5/8" Center to Center Hole Pattern
- 3/4" Steel Backing Plate and Reinforced Striking Plate for Long Life



Front Wheel Drive Hub Puller

SKU OSB **27⁹⁹**
27037

- Fits Most Domestic and Import Vehicles
- Yoke and Bolt are Threaded 5/8" x 18
- Heat-Treated Pressure Screw for Toughness



For OSB, Call 901-300-4878

Tie Rod Tools

Master Inner Tie Rod Tool Set

SKU 344979 **89⁹⁹**
27178

- Works on Both Small Cars and SUVs
- Tube Handle Has an Inner Diameter of 2.125" to Service Small Cars, Pickups and Large SUVs
- Includes 12 Crowfoot Style Adapters, Sizes: 29 mm, 1-3/16", 1-1/4", 32.5 mm, 1-5/16", 33.6 mm, 1-3/8", 1-7/16", 1-1/2", 38.4 mm, 40 mm and 42 mm



Tie Rod End Remover

SKU 209525 **25⁹⁹**
27175

- Comes with Pressure Screw Tip Swivels for Damage Free Results
- Will Not Damage Tie Rod End Dust Boot
- Rust Resistant Finish



Inner Tie Rod Tool Kit

SKU 217377 **52⁹⁹**
27185

- Removes and Installs Tie Rod End on Rack and Pinion Steering
- Includes: 3/16", 5/16" and 7/16" Adapters



Inner Tie Rod Tool

SKU 291414 **119⁹⁹**
LIS45750

- 6 Sizes: 1-3/16", 1-1/4", 1-5/16", 1-7/16", 1-1/2" and 33.6 mm



Pitman Arm Puller

Pitman Arm Puller for Light Trucks

SKU OSB **50⁹⁹**
27170

- Services Cars and Light Trucks 3/4 Ton
- Features Forged Adjustable Jaws and Two Clamp Bolts That Lock Jaws Together
- Pressure Screw Has Ball Head Designed for Striking



For OSB, Call 901-300-4878

Pickle Forks

Stepped Pickle Fork Set

SKU 291410 **84⁹⁹**
LIS41400

- 6 Tools in One
- Includes: 11/16", 15/16", 1-1/8" Forks and 2 Handles



5 Piece Tie Rod and Ball Joint Set

SKU 1103626 **49⁹⁹**
37201 REG. \$69.99

- Used to Remove Tie Rods and Ball Joints
- Includes: 11" x 1-1/8", 11-3/4" x 1-5/8", 11-5/8" x 1-7/16", 16" x 11/16" and 16" x 15/16"

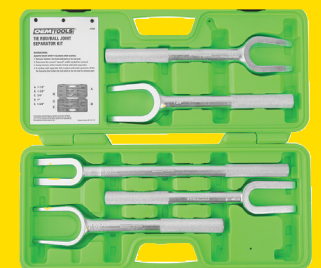

Offer Good Through September 30, 2026

CHASSIS & SUSPENSION

TO ORDER, contact your Commercial Sales Manager or go to AutoZonePro.com

CHASSIS & SUSPENSION

CV Axle Nut Sockets

12 Pt. 39 mm Axle Nut Socket

SKU OSB 27321H **29⁹⁹**

- 1/2" Dr., 39 mm, 12 Point Size Fits Toyota Trucks, SUVs and Others



For OSB, Call 901-300-4878

See AZTOOL1.com for Full Line of CV Axle Nut Sockets

Axle Nut Socket Sets

- Includes Sizes: 29, 30, 32, 34, 35, 36, 38 and 39 mm

6 Pt.

SKU 1103577 37320 **84⁹⁹**



12 Pt.

SKU 1103460 37321 **89⁹⁹**



OEM TOOLS®

Bushing Tool Set

Manual Bushing Installation and Removal Tool Set

SKU 298214 27212 **179⁹⁹**

- Comprehensive Kit for Fast and Effective Removal/Installation of Wheel Bearings/ Suspension Bushings and Seals
- Allows the Technician to Service a Wide Range of Bushings without Removing Components from the Vehicle
- Comes with 20 Sleeves for Hundreds of Combinations
- External Sleeve Diameter: 44, 46, 48, 50, 52, 54, 56, 58, 60, 62, 64, 66, 68, 70, 72, 74, 76, 78, 80 and 82 mm

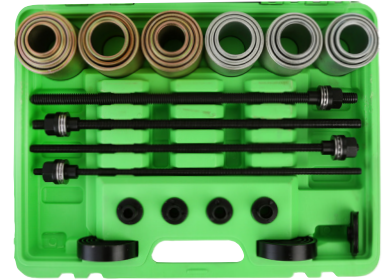

OEM TOOLS®

Axle Tools

CV Axle Puller Adapter

SKU OSB 27058 **11⁹⁹**

- Works with OEMTOOLS 37033, 37191, 27085, 27033, 27202 and Other Slide Hammer Pullers with 5/8" x 18 Threads



For OSB, Call 901-300-4878

CV Axle Popper Set

SKU 1189082 37305 **36⁹⁹**

- Includes: Axle Shim Tool and Fork/Wedge Tool
- Length: 13-3/4"
- Used to Remove Axles from the Transmission, Ball Joints in the Suspension System and Tie Rods
- Fork Design Allows Mechanic to Exert Force Evenly on Both Sides of the Axle



5 Lb. Slide Hammer

SKU 1103572 37033 **59⁹⁹**

- Use to Pull Bushings, Seals, Sleeves, Bearings, Flange-Type Rear Axles, Front-Wheel Drive Hubs, Dents and Pressed-In Bolts with Two or Three Jaw Puller Options
- Slide Rod is 3/4" x 16 Standard Threads



OEM TOOLS®

4WD Spindle Puller

SKU 143436 27104 **44⁹⁹**

- Use with OEMTOOLS Slide Hammer 27033
- Fits Most Spindles 1-1/2", 1-5/8" and 2" on 4 Wheel Drive Vehicles
- Heat-Treated for Strength
- Will Fit on 2 Puller Size Shafts 1/2" x 20 Threads and 5/8" x 18 Threads



Rear Axle Puller Set

SKU 094801 27202 **119⁹⁹**

- Use for Flange-Type Rear Axle and Bearing Removal on Most Late Model Passenger Cars and Light Trucks
- Slide Rod and Adapters are 5/8" x 18 Standard Threads

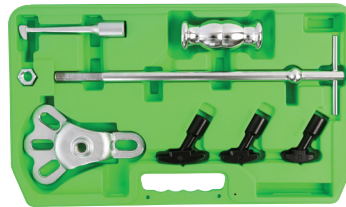

Axle Spindle Threading Set

SKU 1103645 37233 **89⁹⁹**

- Use to Clean or Repair Axle Threads
- Set Comes with a Special Twist Shape That Provides Easier and Quicker Work
- Sizes Included: M20 x 1.25, M20 x 1.50, M22 x 1.00, M22 x 1.50, M24 x 1.50, M24 x 2.00, 13/16" x 20 UNEF, 3/4" x 20 UNEF and 27 mm Extension Bar



Seal Tools

Transmission/Transaxle Plugs

SKU 298196 24490 **19⁹⁹**

- Includes 5 Plugs to Seal Both Transmissions and Transaxles on Most Import and Domestic Vehicles
- Stepped Design for Retention and Positive Sealing
- Includes: Side Gear Centering Pin for Ford Transaxles



Bearing Race and Seal Master Driver Set

SKU 1103639 37119 **49⁹⁹**

- Installs Most Standard Wheel Bearings and Races
- Includes Driver Sizes: 1.565", 1.750", 1.965", 2.325", 2.470", 2.555", 2.830", 2.995", 3.180" and Handle



Seal Puller

SKU 48199 25014 **11⁹⁹**

- 2 Tops Fit All Seal Sizes
- Pops the Seal Out Every Time
- No Pounding or Hammering
- Protects Bearings and Races
- Rubber Handle



OEM TOOLS®

Universal Seal Installer Set

SKU 818737 25082 **45⁹⁹**

- Knurled Long Handle
- Includes: 3" Driver, 2.5" Driver, Short Handle, Long Handle, Spider Insert, 5/16" x 1" Cap Screw, Large Spider, Small Spider and Washer
- Long Handle Provides Good Flexibility When Installing Pinion Seals



Socket Press

C-Frame Socket Press Set

SKU 012659 24537 **269⁹⁹**

- Any Socket with 1/4", 3/8" or 1/2" Drive Can Be Used in Any Combination for Use on Virtually All Cars, ATV/UTV/SxS, Light Duty Trucks and Farm Machinery
- Set Includes Flat Anvil Attachments for General Pressing Jobs
- Capacity 2.5 Ton



OEM TOOLS®

Prices subject to change without notice. Prices do not include applicable taxes, vehicles, tires, rims, installation or optional equipment as shown. Please do not return purchases to the store. For information regarding warranty, repair, or any questions or concerns, call 901-300-4878.

AZG0326

67

CHASSIS & SUSPENSION

U-Joint Tools

OEMTOOLS®

U-Joint Pullers

- Easily Removes Seized U-Joint Cups on Most Passenger Vehicles and Light Duty Trucks
- Does Not Damage the Driveshaft, Yokes, Joints or Bearing Cups

Automotive

SKU 949561 **31⁹⁹**
24539

- Bearing Cup Outside Diameter: 1" to 1.25"

Intermediate

SKU 949565 **44⁹⁹**
24548

- Bearing Cup Outside Diameter: 1.25" to 1.7"

Heavy Duty

SKU 041474 **89⁹⁹**
24538

- Bearing Cup Outside Diameter: 1.5" to 2.2"



24539

Automotive Bearing Cup Installer

SKU 949571 **40⁹⁹**
24549

- For the Installation of Bearing Cups on Light-Duty and Medium-Duty U-Joints
- Efficiently Install 2 Bearing Cups in One Process
- Contact Points Feature Magnets to Retain Bearing Cups During Operation



Spindle Nuts

GM Axle Hub Nut Socket

SKU 298219 **23⁹⁹**
25967

- Applications: GMT900 Silverado, Sierra HDCS, 2-Wheel (2WD) and 4-Wheel (4WD) Drive Cheyenne, Silverado, Escalade, Sierra and Avalanche Trucks with 10.5" or 11.5" Ring Gear
- Has 9 Pins to Fit GM Style Retaining Nuts
- Unapproved Methods Can Damage the Bearing or Result in Shorter Service Life



Dodge Hub Locknut Socket

SKU 344964 **14⁹⁹**
25968

- Fits Dodge 1/2-Ton Pickup Trucks (1994-Newer) with Dana 44 Front Axle and Dana 60 Axle with a Vacuum Disconnect
- Designed to Accommodate the 1-11/16" (43 mm) Wheel Bearing Retaining Nut Which is Recessed into the Hub



Toyota 4 Pin Hub Locknut Socket

SKU 298224 **13⁹⁹**
25969

- Services High Torque Locknuts on Toyota 4WD Vehicles Having Free Wheel (Lock Out) Hubs
- Tacoma (1995-Newer); T100 and 4Runner (1996-Newer)
- Improved Design with Solid Pins for Increased Durability



Ford Rear Axle Nut Wrench

SKU 1392337 **24⁹⁹**
27353

- Services 2003-Newer Ford F-250, F-350 and F-450 Super Duty Trucks with 10-1/2" Rear Axle
- Same as Ford Part Number 205-448
- Use with a 1/2" Drive Ratchet or Breaker Bar



1/2" Drive Socket Bearing Locknut

SKU 231203 **16⁹⁹**
25243

- Fits Adjusting Nuts Found on Ford F150 Trucks (1995 to 1996) and Full Sized Broncos with Automatic Locking Hubs



4WD Ford Spindle Socket, 66.5 mm x 80 mm

SKU 603346 **24⁹⁹**
25965

- Fits Ford F-Series 1/2-Ton Truck and Full-Size Bronco with Manual Hubs; 1995-Newer Ford F-Series 3/4-Ton and 1-Ton Trucks with Manual Hubs; 1959-85 Ford F-Series 1/2- and 3/4-Ton Trucks and Full-Size Bronco; 1960-90 GM 1/2-Ton Truck and Full-Size Blazer/Jimmy; 1969-89 Dodge 1/2-Ton Truck with Manual Hubs; 1969-72 International 1/2-Ton Truck
- 1/2" Sq. Drive



4WD Ford - Dodge Spindle Socket, 76 mm x 80 mm

SKU 603347 **22⁹⁹**
25966

Toyota 8 Pin Front Hub Locknut Socket

SKU 298205 **22⁹⁹**
25962

- Allows for Easy Removal and Installation of Front Hub Lock Nut without Damage to the Nut
- Applications: Toyota 4Runner 2WD (2007 to 2014), Toyota Sequoia (2008 to 2014), Toyota Tundra (2007 to 2014)
- 3/4" Drive



Power Steering

Power Steering Pulley Remover/Installer - Ford, GM, Chrysler

SKU 1103578 **32⁹⁹**
37031

- Includes 2 Screws for Use on Most Ford, Chrysler, GM and VW Power Steering Pulleys
- Pulls Pulleys on GM Belt Driven Vacuum Pumps and Pressed-On Water Pump Pulleys of GM V6 Engines



Steering Wheel Puller

SKU 1103540 **42⁹⁹**
37182

- Designed for All Major Makes and Models
- Sizes Included: 1/4" x 28, 8 mm x 1.25, 5/16" x 18, 5/16" x 24, and 3/8" x 16



Steering Wheel Lock Plate Remover

SKU 70115 **14⁹⁹**
25134

- For Easy Removal and Installation of Lock Plate Snap Rings
- Works on Chrysler and GM Vehicles with or without Tilt Steering Columns
- Reversible Adapter Includes 9/16" - 18 and M14 - 1.5 Threads



Clutch Tool

Self-Adjusting Clutch Tool Kit

SKU 291356 **669⁹⁹**
27209

- For Assembling and Fitting Self-Adjusting Clutches
- Used on: Audi, BMW, Fiat, Mercedes-Benz, Renault, Vauxhall/Opel and Volvo
- 38 Components



Vacuum Pump Tester, Power Steering and Brake Bleeder Set

SKU 1103570 **69⁹⁹**
37070

- Includes: Vacuum Pump Reservoir Jar with Transfer Lid, Storage Lid, Brake Bleeding Adapter Package, Steering Pump Adapters and Tubing



Power Steering Bleeder Set

SKU 434716 **26⁹⁹**
27311

- Reduce Comebacks
- Eliminate Trapped Air in Power Steering and Brake Systems Following Repairs or Fluid Changes
- Includes: 2 Tapered Rubber Adapters to Fit Most Power Steering Pumps and Reservoirs
- Works with a Hand Vacuum Pump



Drive Line Tool

1/2" Drive (12 mm) Ford Drive Line Impact Socket

SKU 420319 **24⁹⁹**
24212

- Applications Include Many Ford Drive Line Bolts
- 12 mm, 12 Pt.



Floor Jacks

2-1/2 Ton Aluminum/Steel Hybrid Floor Jack

SKU 1417557 24869 **249⁹⁹**

- Aluminum and Steel Frame Construction Provides the Benefit of Strength Along with Light Weight
- Padded Jack Handle and Saddle Pad to Prevent Damage to Vehicle
- Dual Pump Design for Quicker Lifting
- Nylon Casters to Protect Sealed Floor Surfaces and Dealer Showrooms
- Min. Height: 3-1/2"
- Max. Height: 19-1/4"
- Length: 25-1/2"
- Weight: 58.2 Lb.



3 1/2" ↓
LOW PROFILE



3 Ton Low Profile Jack with Stands (Pair)

SKU OSB 68969

- Low Profile Jack Min. Height 3-1/8" for Access Under Low Clearance Vehicles
- Dual Pump Design for Faster Lifting Performance
- Jack Stands
- Min. Height: 15-1/2"
- Max. Height: 23-7/16"
- Designed for Cars, Trucks and SUVs



3 1/8" ↓
LOW PROFILE



238⁹⁹

REG. \$279.98

SAVE OVER \$40

When You Buy the Set

For OSB, Call 901-300-4878

4 Ton Hydraulic Service Jack

SKU 1525558 29003 **249⁹⁹**

- Dual Piston Hydraulic System for Quicker More Efficient Lifting
- Nylon Casters Protect Sealed Floor Surfaces and Dealer Showrooms
- Meets ASME PASE-2019 Standards
- 4.3" Saddle Provides Generous Lifting Area and Secure Grip
- Min. Height: 4-3/8"
- Max. Height: 20-1/4"
- Weight: 98.3 Lb.



20 1/4" ↑
MAX HEIGHT



3-1/2 Ton Low Profile Floor Jack

SKU 757109 24837 **279⁹⁹**

- Dual Pump Design for Quicker Lifting
- Min. Height: 3-3/4"
- Max. Height: 20-1/2"
- Length: 27-1/8"
- Weight: 85.8 Lb.



3 3/4" ↓
LOW PROFILE



3 Ton Long/Low Signature Service Jack

SKU 1407611 24868 **299⁹⁹**

- Extra Long and Low Profile is Great for Low Clearance Vehicles, Pickups and SUVs
- Padded Jack Handle and Saddle Pad to Prevent Vehicle Damage
- Dual Pump Design for Quicker Lifting
- Nylon Casters to Protect Sealed Floor Surfaces and Dealer Showrooms
- Min. Height: 3-3/8"
- Max. Height: 24-1/4"
- Length: 31-3/8"
- Weight: 100.3 Lb.



3 3/8" ↓
LOW PROFILE



Foot Pedal at the Rear of Jack Allows Easy Positioning of the Saddle to the Load without Pumping the Handle

3 Ton Low Profile Jack

SKU 1597793 29005 **179⁹⁹**

- Low Profile Professional Quality Floor Jack for Low Clearance Vehicles
- 3-1/8" Minimum Height is Ideal for Sports Cars, Lowered Vehicles, and Lifting Vehicles with Flat Tires
- 4.3" Saddle with Jack Support Pad and Foam Handle Cover to Prevent Damaging Vehicle
- Overload and Bypass Safety Valves Prevent Use Beyond Rated Capacity and Over-Extension
- Max. Height: 19-3/4"
- Length: 26-1/4"
- Weight: 73.7 Lb.



Ideal for Sports Cars, Lowered Vehicles, and Lifting Vehicles with Flat Tires

3 1/8" ↓
LOW PROFILE



2 Ton Off-Road Jack

SKU 1525571 29004 **289⁹⁹**

- Full Length Skid Plate Provides Stability in Soft or Unstable Materials Such as Sand or Gravel
- Heavy Duty Oversized Wheels are Ideal for Navigating on Rough or Uneven Surfaces
- High Lift Adapter Extension for Additional Lift Height Up to 24-3/16" Provides Access to Lifting Points for Off Road Vehicles
- Dual Piston Hydraulic System for Quicker, More Efficient Lifting
- Min. Height without Extension: 6-1/8", with Extension Stage: 11-1/4"
- Max. Height without Extension: 17-15/16", with Extension Stage: 24-3/16"
- Weight: 59.5 Lb.



Heavy Duty Oversized Wheels



Carry Handle for Portability



4-Position Locking Adjustable Height Extender



Secure Lock Detent for Safety and Comfort During Transportation and Operation

24 3/16" ↑
MAX HEIGHT



Full-Length Skid Plate

All OEMTOOLS® Jacks on this page include overload and bypass safety valves and meet ASME PASE 2014 Safety Standards.

JACKS & HYDRAULICS

Wheel Dollies

Mechanical Vehicle Position Dollies

- Easily Lift and Move Vehicles Up to 6,000 Lb.
- 1,500 Lb. Capacity Each

Set of 2 Dollies

SKU 1089031
24793

399⁹⁹



Set of 4 Dollies with Storage Cradle

SKU 1414391
69000

699⁹⁹

REG. \$899.97

**SAVE \$199
OVER**

When You Buy the Set

OEM TOOLS®



Hydraulic Vehicle Position Dollies

- Easily Lift and Move Vehicles Up to 6,000 Lb.
- 1,500 Lb. Capacity Each

Set of 2 Dollies

SKU 298098
24855TWO

469⁹⁹

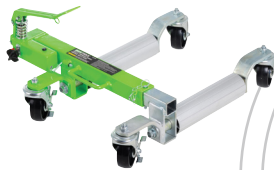

Set of 4 Dollies with Storage Cradle

SKU 696485
68986

749⁹⁹

REG. \$1,039.97

**SAVE \$289
OVER**

When You Buy the Set



1500 Lb. Wheel Dollies Set of Two

SKU 814384
24858

119⁹⁹

- Great for Moving Cars, Trucks, Trailers and Lawn Tractors
- 4 Swivel Nylon Casters Give Mobility in All Directions, Roll Smoothly and are Safe for Epoxy Floors
- HD Steel Plate Construction for a Long Life
- 2 Casters on Each Dolly Have Locking Mechanisms

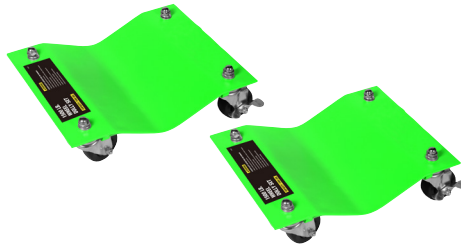

Vehicle Position Dolly Cradle

SKU 544800
24856

99⁹⁹

- Neatly Secure and Store Up to 4 Vehicle Car Dolly Jacks



Jacks Not Included

Air Hydraulic Jacks

OEM TOOLS®

20 Ton Air Hydraulic Bottle Jack

SKU 544795
24850

249⁹⁹

- Can Be Operated with Air or Manually
- Height: 10.25" to 20.1"
- Extension Screw Adjustment: 3.15"
- Meets or Exceeds ASME PASE-2019 Standards



22 Ton Air Hydraulic Truck Jack

SKU 544796
24851

599⁹⁹

- Compact, Low Profile Design Easily and Safely Fits Between Wheels of Tandem Axle Vehicles
- Ram Travel: 4-15/16"
- Extension Screw Adjustment: 4"
- Min. Height: 8-3/4"
- Max. Height: 17-11/16"

OEM TOOLS®



Hydraulic Jacks Built for Performance and Ease of Use

35 Ton Air Hydraulic Axle Jack

SKU 954200
AFF536

1,869⁹⁹

- Unique Motor Design Advances Ram to Load Faster
- Air Assisted Lowering and Dual Return Springs Provide Controlled and Easy Descent
- Safety Overload System Prevents Jack from Being Used Beyond its Rated Capacity
- Corrosion Resistant Aluminum and Nylon Composite Air Motor

AFF



Jack Stands

3 Ton Jack Stands (Pair)

SKU 757122
24852

99⁹⁹

- Min. Height: 11"
- Max. Height: 16-1/2"
- Meets or Exceeds ASME PASE-2019 Standards



6 Ton Jack Stands (Pair)

SKU 1580891
24788

99⁹⁹

- Large Welded Foot Pads Provide Extra Stability and Resist Sinking into Asphalt and Similar Surfaces
- Recessed Saddle for a Secure Placement
- Self-Locking Ratchet Allows Safe and Easy Adjustment
- Features Locking Pin for Additional Security When Under Load
- Max. Height: 23-7/16"
- Min. Height: 15-1/2"
- Meets or Exceeds ASME PASE Standards



OEM TOOLS®

22 Ton Heavy Duty Axle Stands (Pair)

SKU 757098
24854

249⁹⁹

- Min. Height: 12-1/4"
- Max. Height: 19-3/4"
- Adjustable Pin Design
- Features Handle for Transport and Positioning
- Large V-Shaped Saddles Center Lift Points for Secure Placement
- Meets or Exceeds ASME PASE-2019 Standards

OEM TOOLS®



12 Ton Jack Stands with Locking Pin (Pair)

SKU OSB
AFF312C

299⁹⁹

- Wide Pyramid Base Design Provides Added Support And Security
- Large Saddle Allows Better Contact with the Load and Improves Safety
- High-Grade Forged Steel and Welded Design for Maximum Durability

AFF



For OSB, Call 901-300-4878

JACKS & HYDRAULICS

TO ORDER, contact your Commercial Sales Manager or go to AutoZonePro.com

JACKS & HYDRAULICS

Transmission Jacks

1,000 Lb. Telescopic Transmission Jack

SKU 544786 24840 **369⁹⁹**

- Load Capacity: 1,000 Lb.
- Lowered Height: 51"
- Raised Height: 70"
- 2-Way Adjustable Saddle
- Heavy Duty Ram with Controlled Release Feature



70" REACH

OEM TOOLS®

1 Ton 2 Stage Telescoping Transmission Jack

SKU 1142678 26842 **999⁹⁹**

- Second Stage Capacity: 2,000 Lb.
- Lowered Height: 37.5"
- Raised Height: 76"
- 4-Way Adjustable Saddle
- Internal Shaft Retention to Prevent Leaks and Dirt Intrusion

Foot Pedal Pump and Release for Hands-Free Operation



76" REACH

OEM TOOLS®

1,100 Lb. 2 Stage Telescoping Transmission Jack

SKU 1089028 24790 **899⁹⁹**

- Second Stage Capacity: 1,100 Lb.
- Lowered Height: 37"
- Raised Height: 76.4"
- 4-Way Adjustable Saddle
- Fast Lifting Pump

Foot Pedal Pump and Release for Hands-Free Operation



76" REACH

OEM TOOLS®

1,100 Lb. High Lift Transmission Jack with Foot Pump

SKU 750006 24844 **449⁹⁹**

- Load Capacity: 1,100 Lb.
- Lowered Height: 47"
- Raised Height: 79"
- 2 Way Adjustable Saddle
- Spring-loaded Release Valve Stops Lowering When You Let Go



79" REACH

OEM TOOLS®

1 Ton Telescoping Transjak™ Transmission Jack

SKU 902478 RANRTJ1 **1,059⁹⁹**

- Capacity First Stage: 2,000 Lb.
- Capacity Second Stage: 1,000 Lb.
- Lowered Height: 37"
- Raised Height: 71"



71" REACH

Ranger

1-1/2 Ton Telescoping Transmission Jack

SKU 902484 RANRTJ3000 **1,129⁹⁹**

- Capacity First Stage: 3,000 Lb.
- Capacity Second Stage: 2,000 Lb.
- Lowered Height: 35-1/2"
- Raised Height: 71-1/2"



71-1/2" REACH

Ranger

1,100 Lb. Air Assist Transmission Jack

SKU 954225 AFF3052A **1,699⁹⁹**

- 2 Stage Telescopic Ram Designed for Medium Truck Transmissions, Transfer Cases and Differentials
- Chrome Plated Pump Core and Piston Rod Reduces Friction and Provides Long Service Life
- Powder Coat Finish Provides Resistance to Corrosion, Chemicals and Scratches
- Adjustable Saddle with Corner Bracket and Safety Chain
- Double Pump Hydraulic System for Quick Lift Operation
- Adheres to ASME 2014



AFF

78" REACH

AFF3052A

800 Lb. Low-Profile Transmission Jack

SKU 544789 24845 **399⁹⁹**

- Fully Adjustable Saddle Adapts to Most Transmission Pans
- Swivel Saddle Adjusts Both Directions
- Meets ANSI 2014 Standards
- Lowered Height: 8.5"
- Raised Height: 24.5"



24.5" REACH

OEM TOOLS®

Lift Tables

660 Lb. Double-Scissor Lifting Table Cart

SKU 1525568 24789 **499⁹⁹**

- Reduces Operator Strain When Moving Heavy or Bulky Items
- Double-Scissor Mechanism Raises the Table from 13.8" to 50.6"
- Large 32" x 20" Platform Fits a Wide Range of Items
- Foot Pedal Pump Allows Hands-Free Operation
- Hand Operated Release Lever for Easy, Controlled Descent
- 5" Heavy Duty Casters with Bearings for Easy Rolling Over Rough Floors
- Safety Bar Lock Mechanism Allows the Table to Be Secured at 40.2"
- All-Steel Construction for Strength and Durability



OEM TOOLS®

Heavy Duty Hydraulic Table Cart

SKU 1267954 AFF3904 **1,499⁹⁹**

- Total Capacity: 1,100 Lb.
- Positions and Raises Work Piece from 11" to 36"
- Extra Large 32" x 19.5" Work Area
- Foot Operated Pedal Keeps Your Hands Free
- Constructed with 2 Wheel Brakes for Added Safety
- Handle Mounted Pressure Release



AFF

Prices subject to change without notice. Prices do not include applicable taxes, vehicles, tires, rims, installation or optional equipment as shown. Please do not return purchases to the store. For information regarding warranty, repair, or any questions or concerns, call 901-300-4878.

AZG0326

JACKS & HYDRAULICS

Engine Stands

Heavy Duty 1,000 Lb. Engine Stand

SKU 757115 **229⁹⁹**
24839

- Adjustable Mounting Arms to Fit Most Engine Configurations
- Locking Head Plate with 360° Engine Rotation
- Tubular Steel Construction
- Base: 32-1/2" L x 30-3/4" W
- Height: 37-3/8"
- Weight: 41.9 Lb.



1,250 Lb. Engine Stand

SKU 462493 **299⁹⁹**
24829

- Easy to Move and Rotate
- Heavy Gauge Square Steel Tube Frame
- Extra Wide 4 Wheel Base Provides Added Stability
- 360° Rotation
- Lock Pin Locks Engine into Position



1 Ton Folding Engine Stand

SKU 544804 **399⁹⁹**
24834

- Folds Upright to Conserve Valuable Floor Space
- Sturdy, Wide-Base Design to Prevent Tipping Under Load



1,100 Lb. Rotating Engine Stand

SKU 1125862 **599⁹⁹**
24798

- Adjustable Mounting Arms to Fit Most Engine Configurations
- Locking Head Plate with 360° Engine Rotation
- Heavy Duty Worm Gear for Effortless Rotation
- Tubular Steel Construction
- Folding Legs for Easy Storage
- Base: 41-1/4" L x 27-1/8" W
- Weight: 102.5 Lb.



Shop Cranes

2 Ton Folding Shop Crane

SKU 544801 **449⁹⁹**
24830

- Foldable Design Makes for Convenient, Easy Storage
- 6 Solid Steel Caster Wheels Add Mobility
- Fully Adjustable 4 Position Boom



2 Ton Folding Shop Crane

SKU 902288 **684⁹⁹**
RANRSC2TF

- Heavy Duty Hydraulic Folding Engine Hoist with 2 Ton Capacity Ram is Perfect for Shops That Have Limited Space but Still Need the Pure Lifting Convenience of a Crane
- Front Casters Include a Safety Brake to Prevent Movement



6,000 Lb. Heavy Duty Engine Crane

SKU 1267948 **1,579⁹⁹**
AFF3584

- Reinforced Leg Assemblies for Added Strength and Durability
- 4 Different Boom Settings: 3, 2, 1.5 and 1 Ton
- Rear of Crane: 61.5" Tall x 33" Wide
- Distance Between Front of Legs: Retracted 23", Extended 28.5"
- Built-In Safety Overload to Protect the Unit from Being Used Beyond its Rated Capacity



Lifting Accessories

Tesla Jack Pads Models 3/S/X/Y

SKU 1580941 **20⁹⁹**
28999

- One-Piece Molded Rubber Construction
- O-Ring Allows the Adapter to be Pre-Installed onto the Vehicle
- For Use With Floor Jack or 2-Post Lift
- Prevents Damage to the Battery Pack and Rocker Panels



Floor Jack Crossbeam

SKU 544803 **159⁹⁹**
24833

- Compatible with Most Floor Jacks with a 1-1/8" Diameter Saddle Stud
- Saddles Adjust from 23" to 32" on Center
- Min. Width Capacity: 3,000 Lb.
- Max. Width Capacity: 4,000 Lb.



Fuel Tank Adapter

SKU 1407554 **219⁹⁹**
24832

- Makes Fuel Tank Removal Safe and Easy
- Works with Most Transmission Jacks
- Includes: 2 Nylon Straps to Secure Tank
- Foam Rubber Pads
- Protect Tank



Bed Lifter

SKU OSB **340⁹⁹**
STK35885

- Designed to Lift Truck Beds Safely and Easily
- Lifting Brackets Adjusts to Evenly Distribute Weight

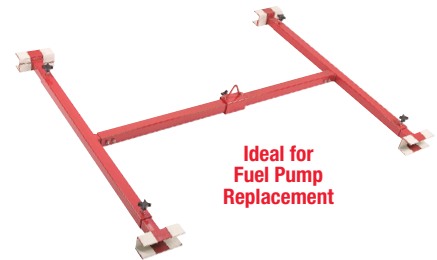

Ideal for Fuel Pump Replacement

For OSB, Call 901-300-4878

Universal Engine Lift Plate

SKU 662861 **24⁹⁹**
24867

- Fits Most 6 and 8 Cylinder Engines with 2 or 4 Barrel Intake Manifolds



Prices subject to change without notice. Prices do not include applicable taxes, vehicles, tires, rims, installation or optional equipment as shown. Please do not return purchases to the store. For information regarding warranty, repair, or any questions or concerns, call 901-300-4878.

JACKS & HYDRAULICS

TO ORDER, contact your Commercial Sales Manager or go to AutoZonePro.com

JACKS & HYDRAULICS

Engine Support

3 Point Engine Support Bar

SKU 133617 **129⁹⁹**
24951

- Makes Removal of Transaxle Easy by Supporting Engine of Front Wheel Drive Vehicles
- Width Expands from 34-1/2" to 61"
- (2) 14" Adjustable Hook Screws
- (2) 38" Braided Steel Cables
- 700 Lb. Capacity



1,100 Lb. Engine Support

SKU 512946 **174⁹⁹**
24950

- 2 Screw Adjusters for Precise Positioning Makes Job Easier, Faster and Safer
- Rubber Feet to Prevent Damage to Vehicle and Ensure Stability
- 1,100 Lb. Capacity



3/4 Ton Engine Leveler

SKU 544802 **89⁹⁹**
24831

- 4 Point Mounting System Provides Maximum Control
- 3 Chain Positions to Accommodate Different Engine Configurations
- Durable Steel Construction
- Smooth Operating Worm Drive Shaft for Easy Level Adjustment
- Rated Capacity: 1,500 Lb.

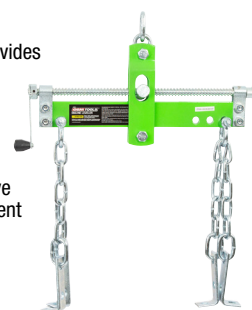

High Reach Stands

- Provides Added Support During Installation/Removal of Automotive Components
- Compact Design for Use in Limited Workspaces
- Durable Heavy Gauge Steel Construction

1,500 Lb. High Reach Jack Stand

SKU 757043
24848

186⁹⁹

- Min. Height: 55"
- Max. Height: 78"
- Meets or Exceeds ASME PASE-2019 Standards



1,500 Lb. High Reach Jack Stand with Foot Pedal

SKU 757078 **219⁹⁹**
24847

- Foot Pedal Pump Saves Time Adjusting Load
- Min. Height: 55"
- Max. Height: 78"
- Meets or Exceeds ASME PASE-2019 Standards

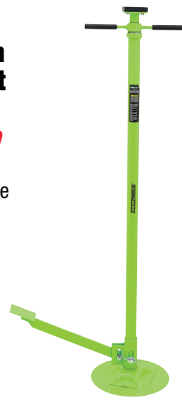

2 Ton Underhoist Tripod Jack Stand

SKU 757084 **199⁹⁹**
24849

- Adjustment Pin Securely Supports Load in 5 Positions
- Min. Height: 49"
- Max. Height: 80"
- Meets or Exceeds ASME PASE-2019 Standards



Powertrain Lifts

EV Lift Table

SKU OSB
CHLBT3300 **13,339⁹⁹**

- 3,300 Lb. Lift Capacity
- Scissor-Style Lifting
- Hydraulic Cylinder and 115V Plug
- Pendant Controlled Operation
- Max. Reachable Height: 76.5"
- Complies with ASME PASE-2019
- 8" Clearance Under Base Plate for Battery Removal
- Extending, Adjusting and Tilting Top Plate for Larger Batteries



Challenger Lifts

2,500 Lb. Powertrain Lift

SKU OSB
AFF3182 **6,349⁹⁹**

- Air Assist Foot Pump with 9' Extension Provides Hands-Free Operation
- Safety Latches at 30%, 50% and 80% of Max. Height
- 8" Diameter Swivel Casters for Easy Maneuverability
- Rear Wheels Can Be Locked to Prevent Rolling
- Table Top Height from 33" to 77"



4,500 Lb. BendPak EV Battery and Powertrain Lift Table

SKU OSB
BENEVS4500

11,899⁹⁹

- Full-Rise Battery Powered Mobile Scissor Lift Table
- Remote Control Operation
- DC Electric Power System with Onboard Charging
- Full-Length Utility Trays



2,200 Lb. Lifting Table, Air/Hydraulic with Adapters

SKU OSB
CEA-MS10KIT **4,499⁹⁹**

- Designed for Removing/Replacing Battery Packs of Electric Vehicles as well as the Engine, Transmission, Drive Axle, Fuel Tank, Suspension and Sub-Frames of Traditional Vehicles
- Large Base Frame Ensures Better Stability and Reliability
- Max. Lift: 70-1/16"
- Min. Height: 22-7/16"
- Platform Length: 51-3/8" to 58-1/4"
- Platform Width: 33-1/8"



Cutting Edge
Automotive Solutions

2,640 Lb. Lifting Table, Electric/Hydraulic with Adapters

SKU OSB
CEA-MS12MKIT **6,999⁹⁹**

To Confirm Price, Availability and Ordering Instructions on OSB, Call 901-300-4878

Prices subject to change without notice. Prices do not include applicable taxes, vehicles, tires, rims, installation or optional equipment as shown. Please do not return purchases to the store. For information regarding warranty, repair, or any questions or concerns, call 901-300-4878.

AZG0326

73

AIR COMPRESSORS

Standard and Premium Compressors



An Atlas Copco Company

The Ironman Series delivers durable, high-performance compressed air solutions.

Built with a full cast iron pump, it's ideal for heavy-duty, auto body and repair shops.



ABAC5-2180V



ABAC7-2180V2



ABAC10-23120V

		5 HP 80 Gallon 230V Air Compressor, 1 Ph		7.5 HP 80 Gallon 230V Air Compressor, 1 Ph		10 HP 120 Gallon 230V Air Compressor, 3 Ph	
		Standard SKU OSB ABAC5-2180V	Premium SKU OSB ABAC5-2180VFFS NEW	Standard SKU OSB ABAC7-2180V2	Premium SKU OSB ABAC7-2180V2FF	Standard SKU OSB ABAC10-23120V	Premium SKU OSB ABAC10-23120VFF
Features	CFM at 100 psi	18 CFM (2-3 Technicians)	18 CFM (2-3 Technicians)	27 CFM (3-5 Technicians)	27 CFM (3-5 Technicians)	35 CFM (4-6 Technicians)	35 CFM (4-6 Technicians)
	Max. Pressure	175 psi	175 psi	175 psi	175 psi	175 psi	175 psi
	Heavy Duty, Low-RPM Cast Iron Pump	✓	✓	✓	✓	✓	✓
	Magnetic Starter Mounted and Wired	✓	✓	✓	✓	✓	✓
	High Flow Belt Guard	✓	✓	✓	✓	✓	✓
	Warranty	2 Years	2 Years	2 Years	2 Years	2 Years	2 Years
Premium Features	Low Oil Level Shut Off		✓		✓		✓
	Auto Tank Drain		✓		✓		✓
	Belt Guard Aftercooler		✓		✓		✓
Price		2,949⁹⁹	3,799⁹⁹	3,599⁹⁹	4,749⁹⁹	4,949⁹⁹	5,449⁹⁹

Before Placing Your Air Compressor Order:

Ensure you select the right size for your needs. We can help you with size selection. Please remember to verify the voltage and phase before purchasing. Upgrading your air compressor may require upgrading your wiring. See page 2 for delivery information.

Questions? Call 901-300-4878



Customer Responsible For Offloading, Liftgate Service Available.

For OSB, Call 901-300-4878

- Free Delivery in 48 Continental United States
- Specifications Subject to Change without Notice or Liability
- Equipment Lead Times and Shipping May Vary
- Customers Responsible for Offloading Equipment Upon Arrival
- Leasing Terms Available, Ask Your AutoZone® Commercial Sales Manager.

AIR COMPRESSORS

FOR HELP with Selection, Confirm Availability and Ordering Instructions, Call 901-300-4878

AIR COMPRESSORS

Duplex Air Compressors

7.5 HP Duplex 2x7.5 230V Air Compressor, 1 Ph

SKU OSB
ABAC7-21120HD **7,699⁹⁹**

- Duplex Air Compressor
- Cast Iron Aftercooler
- Mounted and Wired Magnetic Starters
- Alternating Control to Decrease Downtime
- Dual Control Increases Output
- Fully Programmable Control Panel Settings



10 HP Duplex 2x10 230V, Air Compressor, 3 Ph

SKU OSB
ABAC10-23120HD **9,149⁹⁹**

- Duplex Air Compressor
- Cast Iron Aftercooler
- Mounted and Wired Magnetic Starters
- Alternating Control to Decrease Downtime
- Dual Control Increases Output
- Fully Programmable Control Panel Settings



Single Phase Compressors

3.5 HP 60 Gallon 230V Air Compressor, 1 Ph

SKU OSB
ABA3-2160V1 **1,199⁹⁹**

- Vertical 60 Gallon Tank
- Horsepower: 3.5 HP
- Power Supply (V/Ph): 230V/1
- CFM @ Max. psi: 12.35
- Max. psi: 135



5 HP 60 Gallon 230V Air Compressor, 1 Ph

SKU OSB
ABA5-2160V4 **1,599⁹⁹**

- Vertical 60 Gallon Tank
- Horsepower: 5 HP
- Power Supply (V/Ph): 230V/1
- CFM @ Max. psi: 14.6
- Max. psi: 175



5 HP 80 Gallon 230V Air Compressor, 1 Ph

SKU OSB
ABA5-2180V4NS **1,949⁹⁹**

- Vertical 80 Gallon Tank
- Horsepower: 5 HP
- Power Supply (V/Ph): 230V/1
- CFM @ Max. psi: 14.6
- Max. psi: 175



Gas Compressor

13 HP 30 Gallon Honda Powered Air Compressor

SKU OSB
ABA13-30GH **3,699⁹⁹**

- Horizontal 30 Gallon Tank
- Horsepower: 13HP
- CFM at Max. psi: 22
- Max. psi: 175
- Cast Iron Cylinders
- Recoil and Electric Start

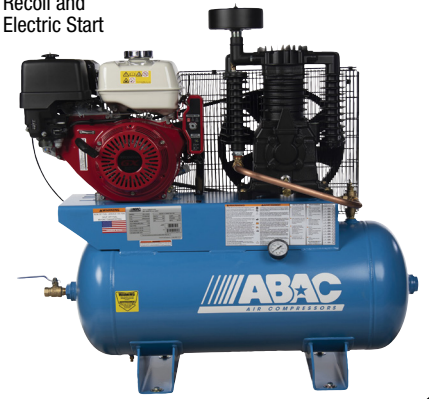

Refrigerated Dryers

- Removes Condensate and Vapor so Dry Compressed Air is Produced in a Continuous, Cost-Efficient Way
- 115 VAC

Cool 15 CFM

SKU OSB
ABAC00L15 **874⁹⁹**

Cool 25 CFM

SKU OSB
ABAC00L25 **1,099⁹⁹**

Cool 35 CFM

SKU OSB
ABAC00L35 **1,249⁹⁹**



ABAC00L15



Rotary Screw Compressors

- High Performance with Low Energy Consumption
- Low Noise and Vibration Levels
- Fully Integrated Aluminum Block

7.5 HP 131 Gallon 150 psi

SKU OSB
ABAAS-75501TM **7,049⁹⁹**

- 230V/1PH
- 27.1 CFM

10 HP 131 Gallon 150 psi with Dryer

SKU OSB
ABAAS-10503TMD **8,549⁹⁹**

- 208V-230V-460V/3PH
- 34.1 CFM

15 HP 131 Gallon 150 psi with Dryer

SKU OSB
ABAAS-15503TMD **11,999⁹⁹**

- 208V-230V-460V/3PH
- 46.4 CFM



ABAAS-10503TMD



Customer Responsible For Offloading, Liftgate Service Available.

For OSB, Call 901-300-4878

- Free Delivery in 48 Continental United States
- Specifications Subject to Change without Notice or Liability
- Equipment Lead Times and Shipping May Vary
- Customers Responsible for Offloading Equipment Upon Arrival
- Leasing Terms Available, Ask Your AutoZone® Commercial Sales Manager.

Prices subject to change without notice. Prices do not include applicable taxes, vehicles, tires, rims, installation or optional equipment as shown. Please do not return purchases to the store. For information regarding warranty, repair, or any questions or concerns, call 901-300-4878.

AZG0326

AIR TOOLS

1/2" Impact Wrenches

Heavy Duty 1/2" Composite Stubby Impact Wrench

SKU 087596 24418 **209⁹⁹**

- Torque: 900 Ft/Lb.
- Includes: (7) 1/2" Short Impact Sockets Sizes 13 mm to 19 mm
- Custom Cut EVA Foam Storage Tray
- CFM: 4.0



WARRANTY: 1 Year

1/2" Impact Wrench

SKU 970487 IRT231HA **239⁹⁹**

- Torque: 590 Ft/Lb.
- Pressure-Fed Lubrication System
- In-Handle Exhaust Directs Air Away from User
- Industry Standard for 3 Decades
- Sound Pressure: 94 to 105 dBA



WARRANTY: 1 Year

1/2" Super Duty Air Impact Wrench with Extended Anvil

SKU 604744 IRT231HA2 **279⁹⁹**

- Max. Torque: 590 Ft/Lb.
- In-Handle Exhaust Directs Air Away from User
- Pressure-Fed Lubrication System



WARRANTY: 1 Year

1/2" Air Impact Wrench Classic

SKU 495316 IRT231C **199⁹⁹**

- Original Twin Hammer Impact
- Torque: 600 Ft/Lb.
- Pressure-Fed Lubrication
- Adjustable Power Regulator
- 1/2" Square Drive



WARRANTY: 1 Year

1/2" Quiet Impact Wrench

SKU 738489 IRT2135QXPA **379⁹⁹**

- Torque: 780 Ft/Lb.
- Light, Quiet and Powerful Impact
- Twin Hammer Mechanism
- Weighs Only 4 Lb.



WARRANTY: 1 Year

1/2" Titanium Air Impact Wrench

SKU 695134 IRT2235TIMAX **469⁹⁹**

- Torque: 1,350 Ft/Lb.
- Reverse Torque: 930 Ft/Lb.
- Twin Hammer Impact Mechanism
- Lightweight



WARRANTY: 2 Years

1/2" Air Impact Wrench with Extended Anvil

SKU OSB IRT2236QTIMAX-2 **464⁹⁹**

- Provides 1,500 Ft-Lb. of Breakaway Torque
- 1/2" Drive 2" Extended Anvil, Compatible with All DXS2 Anvils
- Patented Drive Xchange System™ with 3/8," 1/2" and 3/4" Drive Options and 5 Different Anvil Lengths Ranging from 2" to 10"



WARRANTY: 2 Years
For OSB, Call 901-300-4878

1/2" Nitrocat Composite Twin Clutch Impact Wrench

SKU OSB ACA1250K **419⁹⁹**

- Provides 950 Ft/Lb. Max. Torque and 1,300 Ft/Lb. of Loosening Torque
- Hard Hitting Smooth Twin Clutch Mechanism
- The Twin Clutch is Better Suited for Heavy Duty
- Weight: 4.5 Lb.



WARRANTY: 2 Years
For OSB, Call 901-300-4878

1/2" Compact Impact Wrench

SKU 1580967 ACA1057-TH **219⁹⁹**

- Provides 500 Ft/Lb. Max. Torque and 700 Ft/Lb. of Loosening Torque
- Low Weight Aluminum Alloy Housing
- Weight: 2.80 Lb.
- Length: 3.85"
- Air Inlet: NPT 1/4"



WARRANTY: 2 Years

1/2" Composite Impact Wrench

SKU 80185 ACA1150 **249⁹⁹**

- Provides 900 Ft/Lb. Max. Torque and 1,295 Ft/Lb. of Loosening Torque
- Durable Composite Housing
- Weight: 4.5 Lb.
- Length: 7.5"
- Free Speed: 9,000 RPM



WARRANTY: 2 Years

1/2" Impact Wrench

SKU 1580946 ACA1431 **179⁹⁹**

- Provides 800 Ft/Lb. Max. Torque and 1,000 Ft/Lb. of Loosening Torque
- Cross Bolt Forward/Reverse and Power Management Control
- Weight: 5.7 Lb.
- Length: 7.2"
- Free Speed: 9,000 RPM



WARRANTY: 2 Years

1/2" Composite Impact Wrench

SKU 1580952 ACA1000TH **309⁹⁹**

- Provides 800 Ft/Lb. Max. Torque and 1,000 Ft/Lb. of Loosening Torque
- Patented Quiet Tuned Exhaust (86 dBA)
- Air Cons.: (CFM) 8
- Weight: 4.5 Lb.
- Length: 7.5"



WARRANTY: 2 Years

1/2" Vibrotherm Drive Composite Impact Wrench

SKU 1580965 ACA1178-VXL **384⁹⁹**

- Provides 950 Ft/Lb. Max. Torque and 1,300 Ft/Lb. of Loosening Torque
- Weight: 4.5 Lb.
- Free Speed: 7,500 RPM
- Air Inlet: NPT 1/4"



WARRANTY: 3 Years

AIR TOOLS

TO ORDER, contact your Commercial Sales Manager or go to AutoZonePro.com

AIR TOOLS

3/8" Impact Wrench



3/8" Titanium Impact Wrench

SKU 198065
IRT2115TIMAX

329⁹⁹

- Torque: 300 Ft/Lb.
- Feather Touch Trigger and Patented Push Button Forward/Reverse



WARRANTY: 2 Years

3/4" Impact Wrench



3/4" Composite Impact Wrench

SKU OSB
ACA1778-VXL **719⁹⁹**

- Provides 1,450 Ft/Lb. Max. Torque and 1,700 Ft/Lb. of Loosening Torque
- The Latest Patented Aircat Muffler System Provides the Aircat's Unmatched Low Noise Levels
- Weight: 7.7 Lb.
- Length: 7.7"
- Free Speed: 5,400 RPM



WARRANTY: 3 Years

Don't Forget Your Air Hose Couplers



See Page 79

Air Ratchets



3/8" Air Ratchet

SKU 970485
IRTIR107XPA **184⁹⁹**

- Max. Torque: 54 Ft/Lb.
- Advanced Head Design
- 360° Adjustable Exhaust



WARRANTY: 1 Year

1/4" Super Duty Air Impact Ratchet

SKU 850508
24415 **49⁹⁹**

Impact Mechanism Adds Power and Prevents Kickback

- Max. Torque: 50 Ft/Lb.
- Free Speed: 700 RPM
- CFM: 3.1 @ 90 psi
- Length: 6.5"
- Sealed Head Ratchet Housing Prolongs Tool Life
- Compact and Lightweight
- Most Power-to-Weight Ratio
- Rear Air Exhaust: 360° Adjustable

WARRANTY: 1 Year



Composite Body

3/8" Dr. Air Ratchet Wrench



SKU 662908
KNGNE-343 **144⁹⁹**

- 3/8" Dr. with 75 Ft/Lb. of Max. Reverse Torque
- Forward Working Torque: 10-55 Ft/Lb.
- Free Speed: 160 RPM



WARRANTY: 3 Years

Air Hammers

Standard Duty Air Hammer

SKU 1392327
IRT117 **109⁹⁹**

- 2,000 Blows per Minute
- Heat-Treated Piston and an Alloyed Steel Barrel



WARRANTY: 1 Year

121Q Super Duty Air Hammer



SKU 478945
IRT121Q **164⁹⁹**

- Ideal for Body Panel Crimping and Cutting, Bushing Driving, Shearing and General Front End Work
- Built-In Power Regulator and Trigger Control
- Easy to Control with an "Easy Out" Throttle



WARRANTY: 1 Year

Cut-Off Tool



3" Air Cut-Off Tool

SKU 466590
25760 **52⁹⁹**

- Air Inlet Thread Size: 1/4" NPT
- Free Speed: 22,000 RPM
- Recommended Air Pressure: 90 psi



WARRANTY: 1 Year

Air Drill



3/8" Capacity Keyless Composite Pistol Grip Drill

SKU 1580948
ACA4338 **279⁹⁹**

- Air Consumption: (CFM) 6
- 1,800 RPM
- Reversible and Variable Speed
- Length: 7"



WARRANTY: 2 Years

Inflators



Digital Tire Inflator

SKU 802198
24412 **119⁹⁹**

- Easy-to-Read Backlit LCD Display
- 4 Units of Measure (psi, Bar, KPa, kgf)
- Measuring Range: 0 to 175 psi (0 - 12 Bar)
- Accuracy: +/-1.2 psi Up to 58 psi, +/-2.3 Between 58 psi and 145 psi Inclusive, +/-3.6 psi Greater Than 145 psi
- High Air Flow Saves the Technician Time



2 AAA



Dial Tire Inflator



SKU 301772
24380 **97⁹⁹**

- Clear and Easy-to-Read 80 mm 180 psi Gauge
- 3-In-1 Function: Inflate, Deflate and Measure Tire Pressure
- Increased Accuracy to Improve Tire Performance and Prevent TPMS Comebacks



3.5" Digital Tire Inflator with Hose



SKU 1268419
AST3018 **114⁹⁹**

- 21" Stainless Braided Hose
- Dual AAA Battery Powered Design
- Backlit LCD Digital Read-Out
- Includes Batteries



Dual Head Chuck Tire Inflator Gauge



SKU 094652
25864 **44⁹⁹**

- 6" Chrome Plated Dual-Head Chuck with Full 360° Swivel Action
- 15" Air Hose with 1/4" Female NPT and 3/8" 24 Thread Air Intake
- Inflates within 10 to 120 Lb. Pressure Range
- Magnifying Bubble Lens, Allows Full View of the Pressure Scale
- Gauge in 2 Lb. Increments



Prices subject to change without notice. Prices do not include applicable taxes, vehicles, tires, rims, installation or optional equipment as shown. Please do not return purchases to the store. For information regarding warranty, repair, or any questions or concerns, call 901-300-4878.

AZG0326

77

AIR TOOLS

Surface Prep

Heavy Duty Mini Surface Prep Kit

SKU 087620 **113⁹⁹**
24417

- 2" and 3" Heavy Duty Mini Air Surface Prep Sander
- (1) 2" Backer Pad
- (1) 3" Backer Pad
- (2) 2" and (2) 3" Medium Grit Surface Prep Discs
- (2) 2" and (2) 3" Coarse Surface Prep Discs
- (2) 2" and (2) 3" Sander Discs
- Blow Mold Case



WARRANTY: 1 Year

1/4" Mini Angle Die Grinder and Surface Prep Kit

SKU 94648 **109⁹⁹**
25777

- Air Consumption: 4 CFM
- Free Speed: 20,000 RPM
- Grinding and Cleaning All-in-One Kit
- Comes in a Heavy Duty Plastic Tray



WARRANTY: 1 Year

Air Sanders

2" Surface Prep Air Sander

SKU 094650 **79⁹⁹**
25778

- Includes Quick Change "Twist Lock" Mandrel
- Free Speed: 20,000 RPM
- Average Air Consumption: 3.2 CFM
- Air Inlet Thread Size: 1/4" NPT



WARRANTY: 1 Year

Heavy Duty Reciprocating Air Saw

SKU 802225 **144⁹⁹**
24409

- Recommended Air Pressure: 90 psi
- Air Consumption: 1.7 CFM
- Strokes per Minute: 9,000 SPM
- Air Inlet Thread Size: 1/4" NPT
- Lightweight: 1.50 Lb. (0.70 kg)
- Length: 10.6" (270 mm)
- Exhaust: Front
- Enhanced Blade Guard Design and Trigger Safety Lock
- Includes: Reciprocating Air Saw, 2 Hex Key Wrenches, 2 Saw Blades and 2 Blade Guards



WARRANTY: 1 Year

6" Dual Action Sander

SKU 970475 **164⁹⁹**
IRTIR311A

- Dual Action Pad Motion Reduces Swirl
- Built-In Silencer for Quiet Operation



WARRANTY: 1 Year

Straight Line Sander

SKU 970479 **238⁹⁹**
IRTIR315

- Twin Piston Design for Smooth Operation
- 3,000 Strokes per Minute
- Quick-Action Paper Clamps



WARRANTY: 1 Year

1/4" Die Grinders

Composite Body with Built-In Silencing to Reduce Noise Level

Mini Air Die Grinder

SKU 751631 **59⁹⁹**
24404

- Air Consumption: 2.4 CFM
- Free Speed: 25,000 RPM
- Recommended Air Pressure: 90 psi



WARRANTY: 1 Year

1/4" Air Die Grinder

SKU 802212 **54⁹⁹**
24406

- Air Consumption: 3.4 CFM
- Free Speed: 22,000 RPM
- Recommended Air Pressure: 90 psi
- Exhaust: Rear 360°



WARRANTY: 1 Year

Mini Angle Air Die Grinder

SKU 802214 **79⁹⁹**
24407

- Air Consumption: 2.8 CFM
- Free Speed: 18,000 RPM
- Recommended Air Pressure: 90 psi
- Built-in Silencing to Reduce Noise Level



WARRANTY: 1 Year

Extended Air Die Grinder

SKU 802216 **99⁹⁹**
24408

- Air Consumption: 2.5 CFM
- Free Speed: 23,000 RPM
- Recommended Air Pressure: 90 psi



(Color May Vary)

WARRANTY: 1 Year

Mini Air Die Grinder

SKU 802211 **59⁹⁹**
24405

- Air Consumption: 3.4 CFM
- Free Speed: 25,000 RPM
- Recommended Air Pressure: 90 psi



WARRANTY: 1 Year

AIR TOOL ACCESSORIES

TO ORDER, contact your Commercial Sales Manager or go to AutoZonePro.com

AIR TOOL ACCESSORIES

Impact Sockets and Extensions

1/2" Drive Impact Extension Set

SKU 1340235 **99⁹⁹**
SUN2500

- Set Includes: 1/2" Dr. 3", 5", 10" and 15" Impact Extensions
- Comes in a Blow Mold Case



3/8" Impact Sockets

- 6 Pt. High Quality Impact Sockets
- SAE: 5/16", 3/8", 7/16", 1/2", 9/16", 5/8", 11/16", 3/4", 13/16", 7/8", 15/16" and 1"
- Metric: 8, 9, 10, 11, 12, 13, 14, 15, 16, 17, 18 and 19 mm



Posi-Grip No Slip™ Design Provides Superior Gripping Power for Maximum Torque
Chrome Moly Steel Construction for Strength and Durability

12 Piece Shallow (SAE)

SKU 391191
25589
26⁹⁹

12 Piece Shallow (Metric)

SKU 391190
25587
26⁹⁹



12 Piece Deep (SAE)

SKU 442193
25590
49⁹⁹

12 Piece Deep (Metric)

SKU 464314
25588
44⁹⁹



5 Piece Budd Wheel Socket Set

SKU 1207878 **179⁹⁹**
37384

- 35 mm, 38 mm, 41 mm and 1-1/2" Sockets Feature a Dual Socket Design with a Hex to Remove the Lug Nut and an Internal Square Drive to Remove the Inside Wheel
- 38 mm, 41 mm and 1-1/2" Sockets Each Have a 13/16" Internal Square
- 35 mm Socket Has a 11/16" Internal Square
- Can Be Used with 1" Drive Ratchet, Breaker Bar, Torque Wrench and Impact Wrench



33 mm 1" Drive

SKU 466569 **30⁹⁹**
25528

- 1" Drive 33 mm Budd Wheel Socket for Mack, Midliner, Volvo, White and Other Import Trucks with Dual Rear Wheels

1-1/2" Hex x 13/16" Square Deep 1" Drive

SKU 466570 **25⁹⁹**
25529

- For Budd Wheel 1-1/2" Hex with 13/16" Inside Square

1/2" Impact Sockets

- 6 Pt. High Quality Impact Sockets
- SAE: 3/8", 7/16", 1/2", 9/16", 5/8", 11/16", 3/4", 13/16", 7/8", 15/16" and 1"
- Metric: 10, 11, 12, 13, 14, 15, 16, 17, 18 and 19 mm



11 Piece Shallow (SAE)

SKU 391195
25593
44⁹⁹

10 Piece Shallow (Metric)

SKU 391192
25591
29⁹⁹



11 Piece Deep (SAE)

SKU 391196
25594
74⁹⁹

10 Piece Deep (Metric)

SKU 391194
25592
59⁹⁹



Impact Adapters



5 Piece Adapter and Universal Joint Set (3/8" and 1/2")

SKU 965864 **29⁹⁹**
24226

- Chrome Moly Steel Construction
- Includes: 3/8" Drive Universal Joint, 3/8" Drive (F) x 1/2" (M) Adapter, 1/2" Drive Universal Joint, 1/2" Drive (F) x 3/8" (M) Adapter and 1/2" Drive (F) x 3/4" (M) Adapter



Air Blow Gun



5 Piece Interchangeable Tip Air Blow Gun

SKU 338823 **23⁹⁹**
24439

- Includes 4 Interchangeable Tips: 100 mm (4"), 140 mm (5.5"), 320 mm (12.5") and a Turbo Wide Angle Nozzle
- Quick Change Coupling Makes it Easy to Change Tips
- Wide Angle Nozzle for High Volume
- Variable Trigger for Control Volume and Tip Pressure
- 1/4" NPT Air Inlet



High Flow Couplers

High Flow Coupler and Plug Kits

70% MORE FLOW*

- Ideal for HVLP Spray Guns and High Torque Impact Wrenches
- Delivers the Highest Air Volume with the Lowest Pressure Drop

14 Piece 1/4" Body, 1/4" NPT

SKU 757091 **31⁹⁹**
26134



7 Piece 1/4" Body, 1/4" NPT

SKU 757040 **15⁹⁹**
26132



7 Piece 1/4" Body, 3/8" NPT

SKU 757046 **21⁹⁹**
26133



*When Paired Together, OEMTOOLS High Flow Couplers and Plugs Deliver Up to 70% More Flow than Conventional Couplers

Prices subject to change without notice. Prices do not include applicable taxes, vehicles, tires, rims, installation or optional equipment as shown. Please do not return purchases to the store. For information regarding warranty, repair, or any questions or concerns, call 901-300-4878.

AIR TOOL ACCESSORIES

Surface Prep

Superior Quality Surface Prep Tools

OEMTOOLS®

Try our long lasting surface prep disks that save you time and money.

Surface Prep Discs (25 Pack)

- Twist-Lock Style

2" Coarse

SKU 1330684
22517 **19⁹⁹**
(0.79 each)



3" Coarse

SKU 1335795
22518 **29⁹⁹**
(1.19 each)



2" Medium

SKU 1335806
22516 **19⁹⁹**
(0.79 each)

3" Medium

SKU 1335787
22519 **29⁹⁹**
(1.19 each)



Tool Not Included

2" Twist-to-Lock Surface Prep Discs (50 Pack) with Cookie Jar

Coarse

SKU 1146029
SHA13088 **84⁹⁹**



Medium

SKU 1146030
SHA13089 **84⁹⁹**



Assorted

SKU 1168677
SHA13087 **89⁹⁹**

- Includes: Coarse, Medium and Fine



2" Purple Strip Disc with Twist-Lock (5 Pack)

SKU 298097
SHA16206 **36⁹⁹**

- Long-Life Silicon Carbide for Paint and Coating Removal



2" Twist-Lock Mini Flap Discs Assorted Grits (6 Pack)

SKU 306275
SHA13056 **44⁹⁹**

- Outlasts Mini Grinding Discs by 3 Times
- Includes: 2 Each of 40, 60 and 80 Grit



Twist-Lock Disc Holders

SKU 1368617
SHA13012 **17⁹⁹**

- 2" Holder (Single)



SKU 094911
SHA323T2 **29⁹⁹**

- 2" Holder (2 Pack)



Twist-to-Lock Green Zirconia Mini Grinding Discs



Green Zirconia

SKU	Part #	Size	Grit	Qty	Price
306282	SHA12613	2"	36	25	44.99
305896	SHA12614	2"	50	25	44.99
204022	SHA12615	2"	80	25	44.99
305827	SHA12618	3"	50	25	54.99
204009	SHA12619	3"	80	25	54.99

Cut-Off Accessories

OEMTOOLS®

10 Piece Cut-Off Wheel Set with Mandrel

SKU 1400046
26528 **19⁹⁹**

- Capable of Cutting Fiberglass, Plastic, Iron, Steel and Other Ferrous Metals
- Quantity: (10) 3" x 1/16" Cut-Off Wheels with 3/8" Arbor, 46 Grit
- Max. RPM: 20,400



Mandrel Set for Cut-Off Tools (2 Pack)

SKU 094907
SHA32 **29⁹⁹**



3" Aluminum Cutting Wheels (10 Pack)

SKU 306331
SHA13178PK2 **55⁹⁹**

- Silicon Carbide Grain
- Includes: (10) 3" x 1/16" x 3/8" Cut-Off Wheels
- Works on 3" Die Grinders



3" x 1/16" x 3/8" Reinforced Cut-Off Wheels (25 Pack)

SKU 306273
SHA25E5PK5 **74⁹⁹**

- For Use with Pneumatic Cut-Off Tools
- Max. RPM: 25,000
- Includes: 25 Discs



AIR TOOL ACCESSORIES

TO ORDER, contact your Commercial Sales Manager or go to AutoZonePro.com

AIR TOOL ACCESSORIES

Regulators/Filters/Drains

5 Stage Desiccant Filter/Dryer

SKU 543076 **549⁹⁹**
ARRC7612XL

- Includes: Gauge, Shut-Off Valve and (1) 1/2 Gallon of Desiccant
- Lowers the Dew Point to -30°F



Filter/Regulator (1/2")

SKU 543071 **109⁹⁹**
ARRB754G

- Operating Pressure Range 5 to 125 psi
- 40 Micron Element
- 3 Position Non-Rising Adjustment Knob



Filter Regulator Lubricator (1/2")

SKU 543075 **279⁹⁹**
ARRC33354

- Cleans, Dries and Lubricates Air Supply
- Operating Pressure Range: 5 to 125 psi
- 40 Micron Element
- 142 CFM



Extend the Life of Your Air Tools!

1/2" Electronic Drain

SKU 543065 **99⁹⁹**
ARR5804

- Automatically Drains Compressor Tanks, Receiver Tanks or Filters
- 110 Volt
- 6' Power Cord



Regulator with Gauge (1/4")

SKU 543086 **49⁹⁹**
ARRR262G

- Adjustment Range is 5 to 125 psig
- Rated for 25 SCFM



Air Regulator with Gauge (1/2")

SKU 543091 **79⁹⁹**
ARRR354G

- Adjustment Range is 5 to 125 psig
- Rated for 100 SCFM



Air Regulator with Gauge (3/8")

SKU 543088 **79⁹⁹**
ARRR353G

Hoses and Hose Reels

50' Nitrile Rubber Hose 3/8"

- Lays Flat Under Pressure for Easy Maneuverability and Safety
- Meets PFAS-Free Regulations
- Resists Abrasions and Kinks
- UV Protective Material
- Excellent Resistance to Grease, Oil and Weather

SKU 1491310 **67⁹⁹**
LIN72N3850

- 1/4" NPT Brass Fittings



1/2"

SKU 1491309 **94⁹⁹**
LIN72N1250

- 1/2" NPT Brass Fittings

50' Premium Hybrid Hose

- Lightweight Design for Ease of Use and Enhanced Portability
- Kink Resistant with All-Weather Flexibility (-40° to 150°F)

SKU 1491308 **62⁹⁹**
LIN72H3850

- 1/4" NPT Brass Fittings

SKU 1491307 **94⁹⁹**
LIN72H1250

- 1/2" NPT Brass Fittings

LINCOLN

100' Wall Mount Air Hose Reel

SKU 291343 **42⁹⁹**
25970

- Comes with 18" Leader Hose
- Mounts Solid or with Swivel Action
- Solid Steel Frame
- Some Assembly Required



3/8" x 50' Air Hose Reel

SKU 900815 **164⁹⁹**
25979

- Smooth Automatic Retracting Spring Coil
- 50' Hose
- 3/8" NPT Fittings
- Max. Pressure: 250 psi

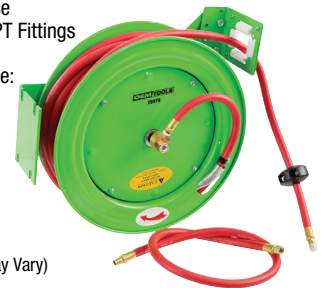

(Color May Vary)

3/8" x 50' Hybrid Polymer Air Hose with Reel

SKU 347224 **124⁹⁹**
24424 REG. \$199.99

SAVE **\$75**

- Heavy Duty Polymer Hose Material Redefines Flexibility - Stays Flexible Under All Weather Conditions (-40° to 150°F)
- Holds No Memory - Kink Resistant Under Pressure
- 300 psi Working Pressure
- Bend Restriction for Reducing Wear and Tear and Extending Life of Hose
- Solid Brass MNPT Ends



Offer Good Through September 30, 2026

Value Series Air Hose Reel

- Retractable Delivery Hose
- Durable Heavy Gauge Steel Construction
- Slotted Mounting Base for Easy Installation

SKU 972284 **309⁹⁹**
LIN83753

SKU 972285 **329⁹⁹**
LIN83754



LINCOLN

3/8" x 50' Retractable Air Hose Reel

SKU OSB **183⁹⁹**
LEGL8250FZ

- Extreme All-Weather Flexibility, Even in Subzero Temperatures (-40° to 140°F)
- Won't Kink Under Pressure



For OSB, Call 901-300-4878

ELG-VITEX

Air Chuck

Dual Foot Air Chuck with Comfort Grip Handle

SKU 802201 **28⁹⁹**
24413

- Comfortable Screwdriver Style Handle
- 30° Reverse Angle Chuck Can Be Used on Outside Tires
- Tilt Lock Feature Locks onto the Valve



Air Chuck with Comfort Grip Handle

SKU 802200 **19⁹⁹**
24414

- Durable, OEMTOOLS Screwdriver Style Handle for Comfort and a Positive Grip
- Sealed-Ball Air Chuck is Extended 1" from Handle to Allow Access to Tight Areas



OEM TOOLS

Prices subject to change without notice. Prices do not include applicable taxes, vehicles, tires, rims, installation or optional equipment as shown. Please do not return purchases to the store. For information regarding warranty, repair, or any questions or concerns, call 901-300-4878.

AZG0326

81

POWER TOOLS

Professional OEMTOOLS®

20V Max* Li-ion
Heavy Duty 1/2" Impact Wrench
 SKU 818594 **219⁹⁹**
 24481

- Speed: 0 to 2,200 RPM and 0 to 2,900 IPM
- Nut Busting Torque: 300 Ft/Lb.
- Tightening Torque: 260 Ft/Lb.
- Weight: 8 Lb.
- Battery Light Indicators
- Charge Time: 2 Hrs.
- Includes: 4.0Ah Li-ion Rechargeable Battery with Charging Station and Sturdy Blow Mold Storage Case



20V Max* Li-ion
1/2" Brushless Impact Wrench
 SKU 592251 **249⁹⁹**
 24486

- Variable Speed: 0 to 2,600 RPM and 0 to 3,000 IPM
- Nut Busting Torque: 300 Ft/Lb.
- Tightening Torque: 260 Ft/Lb.
- Charge Time: 2 Hrs.
- Weight: 9.28 Lb.
- Includes: Rechargeable 4.0Ah Li-ion Battery, Charging Station and Sturdy Blow Mold Storage Case



OEMTOOLS®

20V MAX* LI-ION

BRUSHLESS MOTOR

20V Max* Li-ion
1/2" Brushless Hammer Drill
 SKU 593469 **229⁹⁹**
 24485

- Variable Speed: 0-600 RPM and 0-2000 RPM
- Max. Torque: 310 In/Lb.
- Electric Brake
- Clutch: 21 + 1 Torque Setting
- Charge Time: 1 Hour
- Includes: Rechargeable 2.0Ah Li-ion Battery, Charging Station and Sturdy Blow Mold Storage Case



20V Max* Li-ion
Cordless Angle Grinder
 SKU 598786 **179⁹⁹**
 24492

- Speed: 0 to 10,000 RPM
- Max. Disc Diameter: 4-1/2"
- Spindle Thread: 5/8"
- Spindle Lock: Yes
- Charge Time: 2 Hrs.
- Includes: Grinding Disc, Assist Handle, Rechargeable 4.0Ah Li-ion Rechargeable Battery and Charging Station



20V Max* Li-ion
Reciprocating Saw
 SKU 592353 **169⁹⁹**
 24491

- Variable Speed: 0 to 3,000 RPM
- Overall Length: 14-1/4"
- Charge Time: 1 Hour
- Includes: High-Quality, Multi-Purpose Bi-Metal Reciprocating Saw Blade, Rechargeable 2.0Ah Li-ion Battery and Charging Station



20V Max* Li-ion
6-1/2" Circular Saw
 SKU 592349 **259⁹⁹**
 24488

- No-Load Speed: 3,800 RPM
- Arbor Size: 5/8"
- Depth of Cut (at 45°): 1-9/16"
- Depth of Cut (at 90°): 2-1/8"
- Battery: 4.0Ah Li-ion
- Charge Time: 2 Hours
- Weight: 10.35 Lb.



All Professional OEMTOOLS 20V Power Tools Work with:

Battery Charger
 SKU OSB 27333B **52⁹⁹**



For OSB, Call 901-300-4878

Replacement Batteries

2.0Ah
 SKU OSB 27333A **79⁹⁹**



4.0Ah
 SKU OSB 27314AM **99⁹⁹**

*With respect to 20V Max, Maximum initial battery voltage (measured without a workload) is 20 volts. Nominal voltage is 18V.

Corded OEMTOOLS®

20V MAX* Li-ion Jig Saw
 SKU 592269 **159⁹⁹**
 24489

- Variable Speed: 0-2500 SPM
- Bevel Capacity: 45°
- Orbital Positions: 3
- Stroke Length: 3/4"
- Battery: 2.5Ah Li-ion
- Charge Time: 1 Hour
- Weight: 6.39 Lb.
- Includes: 20V MAX* Li-ion Jig Saw, 1 High-Quality Blade for Wood, Rechargeable 2.5Ah Li-ion Slide Battery and Charging Station



7" Variable Speed Polisher
 SKU 592258 **139⁹⁹**
 24496

- No-Load Speed: 1000 to 3000 RPM
- Power: 11 Amps
- Spindle Thread: 5/8"
- Spindle Lock: Yes
- Power Cord Length: 6 Ft.
- Includes: Sanding Paper, Sanding Pad, Terry Bonnet, Wool Bonnet and Foam Piece



OEMTOOLS®

6" Bench Grinder With LED Light
 SKU 412601 **129⁹⁹**
 80057

- 2.1 Amp, 1/3 HP Motor Delivers Consistent Power Without Boggling Down
- Ultra-Bright LED Lights and Dual Spark Shields Protect and Illuminate
- Adjustable Work Rests and Heavy-Duty Steel Base Ensure Accuracy and Reduced Vibration
- Dual 6" Aluminum Oxide Wheels Handle Grinding, Deburring, Cleaning
- Max Speed: 3450 RPM



OEMTOOLS®

Bench Grinding Wheel 6" X 3/4" 46 Grit

- SKU 112398 **49⁹⁹**
 SHA2017
- Economical, Long Lasting Abrasive Wheels



SHARK USA

14" Chop Saw
 SKU 1228718 **279⁹⁹**
 24723

- Ideal for Cutting Wood, Metal, Steel and Pipe
- 15 Amp Motor for Powerful Cutting Action
- Spindle Lock Makes Wheel Changes Quick and Easy
- Accepts Standard 14" Cutoff Discs
- Includes: Cutting Blade and 6 Ft. Power Cord



OEMTOOLS®

OEMTOOLS®

20V Max* Li-ion
3/8" Cordless Drill
SKU 052383 **67⁹⁹**
24660

- Chuck Size: 1/2" Keyless Jacob's Chuck
- No-Load Variable 2 Speed Gear Box: 0 to 350 RPM and 0 to 1,150 RPM
- Max. Torque: 220 In/Lb.
- Max. Drilling Capacity: 5/16" (Metal) and 3/4" (Wood)
- Keyless, Auto Spindle Lock Chuck Size: 3/8"
- Clutch: 16 + 1 Torque Clutch Setting
- Electric Brake
- Forward and Reverse Switch
- Battery Charge and Capacity Indicator Lights
- Charge Time: 4 to 6 Hrs.
- Includes: 1.5Ah Li-ion Rechargeable Battery and Battery Charger



STORE STOCKED

20V Max* Li-ion
3/8" Cordless Impact Wrench
SKU 052379 **82⁹⁹**
24661

- Anvil: Heat-Treated 3/8" Drive Ball Detent
- Variable Speed: 0 to 2,400 RPM and 0 to 3,000 IPM
- Max. Torque: 200 Ft/Lb. (Forward) and 240 Ft/Lb. (Reverse)
- Battery: 1.5Ah Li-ion
- Electric Brake
- Battery Charge and Capacity Indicator Lights
- Charge Time: 3 to 5 Hrs.
- Includes: 1.5Ah Li-ion Rechargeable Battery and Diagnostic Fast Battery Charger



STORE STOCKED

20V Max* Li-ion
1/2" Cordless Impact Wrench
SKU 052380 **99⁹⁹**
24670

- Anvil: 1/2" Square Drive
- Speed: 0 to 2,200 RPM; 0 to 2,700 IPM
- Nut Busting Torque: 300 Ft/Lb.
- Max. Tightening Torque: 240 Ft/Lb.
- Battery: 2.0Ah Li-ion
- Weight: 6.5 Lb.
- Charge Time: 5 to 7 Hrs.
- Includes: 2.0Ah Li-ion Rechargeable Battery, Li-ion Battery Charger



STORE STOCKED

Individual Batteries and Charger Available

20V Max* Li-ion
Battery 1.5 Amps
SKU 029415
24660A **59⁹⁹**
• Charges in 4 to 6 Hrs.



20V Max* Li-ion
Battery 2.0 Amps
SKU 1392334
24670-36 **57⁹⁹**
• Charges in 4 to 6 Hrs.



20V Max* Li-ion
Battery Charger
SKU 029418
24660B **19⁹⁹**



4-1/2" Compact Angle Grinder
SKU 052382 **43⁹⁹**
24663

- Motor: 6 Amp
- Voltage: 120V, 60 Hz
- Speed: 10,500 RPM
- Interchangeable Handle for Left or Right Hand Use
- Heavy Duty, Cast Aluminum Gear Head for Strength and Durability
- 6 Ft. Power Cord
- Includes: Grinding Wheel, Spanner Wrench and Disc Guard



STORE STOCKED

Heavy Duty 1/2" Impact Wrench
SKU 052388 **69⁹⁹**
24666

- Input Power: 8.5 Amp
- Voltage: 120V, 60 Hz
- 1/2" Square Drive with Hog Ring Retainer
- No-Load Speed: 0 to 2,200 RPM and 0 to 3,000 IPM
- Replaceable Carbon Brushes
- 8 Ft. Power Cord



STORE STOCKED

Rotary Tool with 35 Piece Accessory Kit
SKU 052384 **43⁹⁹**
24664

- Input Power: 1.2 Amp
- Voltage: 120V, 60 Hz
- No-Load Speed: 10,000 to 35,000 RPM
- Collet Capacity: 1/8" to 3/32"
- Spindle Lock for Easy Bit and Accessory Change
- 6 Ft. Power Cord
- Includes: Grinding Stones, Wheels, Brush, Sanding Bands and Disc, plus Grinding, Cloth and Cut-Off Wheels



Includes 35 Piece Accessory Kit



STORE STOCKED

Flexible Shaft Rotary Tool Extension
SKU 003483 **19⁹⁹**
24657

- Easily Attaches to Many Popular Rotary Tools

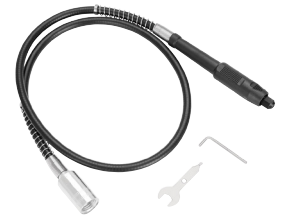

12V Max** Li-ion
Power Ratchet
SKU 1069064 **69⁹⁹**
24685

- Max. Torque: 35 Ft./Lb.
- Max. Manual Torque: 96 Ft./Lb.
- No-Load Speed: 230 RPM
- Ergonomic Grip with Low-Profile Head for Work in Tight Spaces
- Features Integrated Worklight for Hard-to-See Spots
- Includes: 2Ah Li-ion Removable Battery and Charger



STORE STOCKED

Dual Temp Heat Gun
SKU 052387 **29⁹⁹**
24665

- Input Power: 10 Amp
- Voltage: 120V, 60 Hz
- Temperature Settings: 482°F/842°F
- Trigger: 3 Position Rocker
- Hanging Loop for Storage
- 6 Ft. Power Cord



STORE STOCKED

*With respect to 20V Max, Maximum initial battery voltage (measured without a workload) is 20 volts. Nominal voltage is 18V.

**With respect to 12V Max, Maximum initial battery voltage (measured without a workload) is 12 volts. Nominal voltage is 10.8V.

POWER TOOLS

Power Tool Accessories

33 Piece Impact Rated Driving Bit Set

SKU 750443 **18⁹⁹**
25960

- Designed to Withstand High Torque Applications
- Reduces Wear, Stripping and Cam-Out
- Includes: Magnetic Impact Rated Bit Adapter

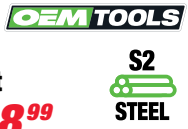

6 Piece Bi-Metal Hole Saw Set

SKU 547011 **35⁹⁹**
24378

- Includes: Sizes: 7/8", 1", 1-1/8", 1-1/4" and 1-1/2" (22 mm, 25 mm, 29 mm, 32 mm and 38 mm)
- Slotted Saw Allows for Easier Plug Removal
- Durable Enamel Finish Protects Against Corrosion
- Bi-Metal Construction for Increased Wear Resistance



Multi-Purpose Drill Powered Pump

SKU 526513 **48⁹⁹**
24503

- Works with a Corded or Cordless Drill to Transfer the Following Liquids: Fresh Water, Sea Water, Organic Solvents, Motor Oil, Heating Oil, Insecticides and Liquid Fertilizers



Bench Grinder, Vise and Drill Press Stand

SKU 943120 **164⁹⁹**
24643

- Heavy Duty Steel Construction Features Large Base to Prevent Walking or Wobbling During Operation and is Pre-Drilled for Mounting
- Top/Plate Dimensions: 13.8"(L) x 9.8"(W) x 0.2"(H)
- Overall Dimensions: 13.8"(L) x 9.8"(W) x 37.4"(H)

Multiple Mounting Configurations Fit Many Bench Grinders, Pipe Benders, Vises and Drill Presses



4-1/2" x 1/16" x 7/8" Cut Off Wheel Pack of 6

SKU 1485031 **19⁹⁹**
26510PK

- 4-1/2" Wheel Diameter
- 1/16" Wheel Thickness
- 7/8" Arbor Diameter
- Will Evenly Cut Through Fiberglass, Plastic and Steel
- Arbor Diameter Fits Most Drills



3 Piece Spiral Step Drill Set

SKU 99189 **34⁹⁹**
24372

- Titanium Two-Flute Spiral for Longer Life, Faster Drilling and Less Vibration
- Split Point Generates Less Heat
- Bit One: 13 Sizes from 1/8" to 1/2"
- Bit Two: 6 Sizes from 3/16" to 1/2"
- Bit Three: 9 Sizes from 1/4" to 3/4"
- 28 Hole Sizes in 3 Bits
- Enlarge Existing Holes
- 1/4" Hex Shank To Prevent Slipping in Chuck
- Applicable Materials: Stainless Steel, Copper, Brass, Aluminum, Plastic and Laminates (Material Thickness of 0.125")



Nine-Step Drill Bit

SKU OSB **19⁹⁹**
26537

- Sizes Include: 1/4", 5/16", 3/8", 7/16", 1/2", 9/16", 5/8", 11/16" and 3/4"



4.5" Depressed Center Grinding Wheels

SKU 1485045 **14⁹⁹**
SHA12734

- Type 27 Aluminum Oxide Grinding Wheels
- Arbor: 7/8"
- Diameter: 4.5 by 1/4"
- Hubless, 24 Grit
- Pack Contains 3 Wheels



Mechanics Set

SKU 533204 | 24974

1,999⁹⁹ REG. \$2,355.51

SAVE \$355

Includes 156 of the Most Common Tools in Tool Cart

- SAE and Metric, 1/4", 3/8" and 1/2" Drive Tools, Combination Wrench Sets, Pliers and Screwdrivers. Plus Battery Service Tools, Oil Change Tools and More

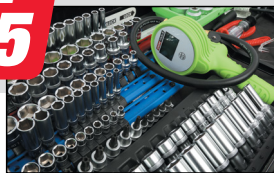

Go to AZTOOL1.com for 24974 Contents List

Cart Style and Color May Vary

Offer Good While Supplies Last Through September 30, 2026

Technicians Set

SKU 533203 | 24975

2,649⁹⁹ REG. \$3,203.22

SAVE \$553

Includes 312 of the Most Common Tools in Tool Cart

- SAE and Metric, 1/4", 3/8" and 1/2" Drive Tools, Combination Wrench Sets, Pliers and Screwdrivers. Plus Battery Service Tools, Oil Change, Wheel Service and More



Go to AZTOOL1.com for 24975 Contents List

Cart Style and Color May Vary

Offer Good While Supplies Last Through September 30, 2026

ATOMIC 20V MAX* Right Angle Grinder Kit with XR POWERSTACK™

399⁹⁹

SKU 1697898
DCG422GE1



20V MAX* XR® Brushless 3/8 In. & 1/2 In. Sealed Head Ratchet with Powerstack™

379⁹⁹

SKU 1659068
DCF510GE1



20V MAX* XR® 1/2 In. High Torque Impact Wrench Kit

349⁹⁹

SKU 1406800
DCF900P1



ATOMIC™ 20V MAX* 3/8 In. Impact Wrench

239⁹⁹

SKU 1431519
DCF923B



ATOMIC™ 20V MAX* 1/2 In. Impact Wrench

239⁹⁹

SKU 1431516
DCF921B



ATOMIC™ 20V MAX* Die Grinder

249⁹⁹

SKU 1659070
DCG420B



ATOMIC™ 20V MAX* 4 In. Angle Grinder Kit with XR POWERSTACK™

599⁹⁹

SKU 1659072
DCG400S2



ATOMIC™ 20V MAX* 4-1/2 In. Angle Grinder

229⁹⁹

SKU 1659069
DCG402B



7 In. - 9 In. Variable-Speed Polisher with Soft Start

279⁹⁹

SKU 559124
DWP849X



20V MAX* 2-Speed Grease Gun

319⁹⁹

SKU 1659071
DCGG581B



20V MAX* Cordless Air Inflator

169⁹⁹

SKU 1328190
DCC0201B



20V MAX* XR® 3 In. Brushless Cut-Off Tool

199⁹⁹

SKU 1431517
DCS438B



ATOMIC™ 20V MAX* Brushless 2-Tool Combo Kit

279⁹⁹

SKU 1431518
DCK226D2



20V MAX* XR® Brushless Reciprocating Saw Kit with XR POWERPACK™

379⁹⁹

SKU 1659067
DCS384WW1



When you buy DEWALT® tools from AutoZone®, you don't just get great tools, you get rewarded.

When you purchase these select tools, use sbdazpromo.com or QR code to submit your purchase and unlock your FREE bonus battery or accessory item.



* Maximum initial battery voltage (measured without a workload) is 20 volts. Nominal voltage is 18.

ALIGNMENT

Ask About Special Pricing on Additional Multi-Lifts and Package Deals, Call 901-300-4878

SAVE \$1,099*

geoliner® 609 with 12K 4-Post Lift

SKU OSB
ALIGNCOMB020 **37,899⁹⁹**

- Provides Accurate, Real-time Measurements - Reduces Setup and Measurement Times While Generating Serious Productivity Benefits
- Ultra Low-Profile Design Allows Easy-On Approach Angle for Low Profile Vehicles
- Hydraulic Cylinder Mounted Underneath Runway
- Closed Front Design



* Savings based on the price of items if purchased separately.

SAVE \$1,399*

geoliner® 678 Complete Alignment System with 12,000 Lb. Scissor Lift

SKU 1350794
ALIGNCOMB026 **57,199⁹⁹**

- Includes: geoliner® 678 Aligner w/AC400 Clamps and VIN Reader, 12,000 Lb. Scissor Lift with (2) Rolling Jacks, Air Line Kit, Turn Plates and Rollback Kit
- Open Front Design Provides Easy Access to Alignment Service and Calibration Areas
- 24" Wide Runways Provide Easy Drive-On for Large Vehicles
- 70" Lifting Height



* Savings based on the price of items if purchased separately.

HOFMANN®



ALIGNER INCLUDES: Manufacturer's Set-Up

INCLUDES: (2) Rolling Jacks, Air Line Kit, Premium Turn Plates and Rollback Kit

WARRANTY: 1 Year Parts and Labor

X-613 Mobile Wheel Aligner

SKU OSB
LAU702020112TF **14,839⁹⁹**

- 2-in-1 Alignment and Diagnostics Including X431 Throttle V
- Professional Scan Tool Codes, Resets, Full System Diagnostics
- OEM Remote Programming Ready J2534 with 30 Day Trial
- No Alignment Rack Needed, Works without Dedicated Lift
- Fully Mobile - No Installation, No Cabinets or Fixed Equipment

Use with Any Scissor or 4-Post Lift

Perform Alignments without Investing in a Dedicated Rack or Expanding Shop Space

- Wireless Magnetic Cameras - Fast Setup, No Wiring
- Self-Calibrating System - Quick, Accurate Results
- Works on Any Lift or Floor, Maximum Flexibility
- OE Level Specs Powered by MOTOR Database
- Complete Kit Includes: Clamps, Targets, Turntables and Locks

LAUNCH

NEW

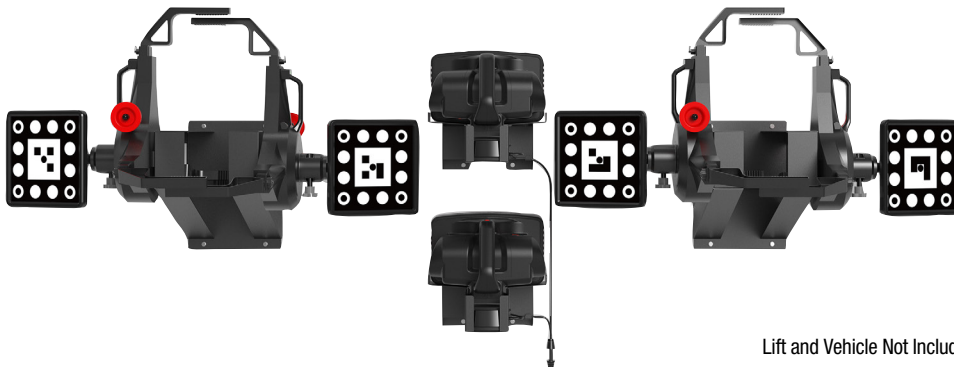

Customer Responsible For Offloading, Liftgate Service Available.

For OSB, Call 901-300-4878

- Free Delivery in 48 Continental United States
- Specifications Subject to Change without Notice or Liability
- Equipment Lead Times and Shipping May Vary
- Customers Responsible for Offloading Equipment Upon Arrival
- Leasing Terms Available, Ask Your AutoZone® Commercial Sales Manager.

Aligners

CEMB Wheel Alignment Systems

- User Friendly Software with Adjustment Graphics
- More Than 55,000 Vehicles In Database
- Cloud Based Wi-Fi Networking
- 12" to 24.5" Clamping Range
- For Cars and Light Trucks

Trolley Wheel Alignment System

SKU **OSB**
CMBDWA1100TROLL **12,699⁹⁹**

- Toughpad with 10" Touch Screen, Waterproof, Dustproof Rubberized Case

Complete Wheel Alignment System

SKU **OSB**
CMBDWA1100CWAS **18,799⁹⁹**

- Portable Wheel Stands with Integral Turn Plates on All Four Stands Align All Vehicles
- Stands Weight Limit: 10,000 Lb. or 2,500 Lb. per Stand
- Includes: Stands, Roller and Plates

ALIGNER INCLUDES:
Manufacturer's Set-Up and Training

WARRANTY:
2 Years Parts, 1 Year Labor



CMBDWA1100TROLL

Wheel Alignment System

SKU **OSB**
CMBDWA1100 **16,499⁹⁹**

- Includes: Cabinet, Printer, Depressor, Holder and Software

DWA3500 3D High Definition Wheel Alignment System

SKU **OSB**
CMBDWA3500 **20,399⁹⁹**

- 3D HD Camera Technology
- Portable Cabinet/Tower Moves Bay-to-Bay
- Adjustable Camera Height Follows Alignment Rack
- Complete 4-Wheel Alignment System
- Includes: 24" Monitor, Color Printer, Compact Wheel Targets and User-Friendly Software
- FREE 1-Year Spec Update and Shop Alignment Banner

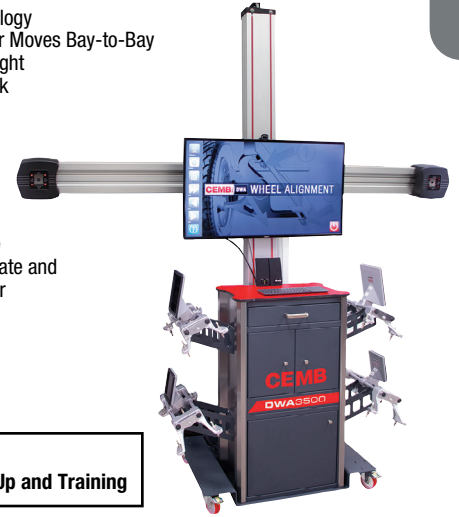

ALIGNER INCLUDES:
Manufacturer's Set-Up and Training

WARRANTY:
2 Years Parts, 1 Year Labor

CWA 6500 Wheel Aligner

SKU **OSB**
AMM8006500 **28,649⁹⁹**

- Comes with Both Self-Centering Clamp and Exclusive Tire Gripping Adapters to Ensure Both Accurate Reading and Fast Operation
- Multiple Compensation Modes to Make Getting Readings on Heavy Vehicles Easy without Having to Roll Vehicle Excessively Far
- Two Wheel Alignment Mode for Setting Total Tow on Large Trucks, No Rear Targets Required
- Standard VIN Scanner for Time Savings and Ease of Vehicle Selection
- Mobile Cabinet Supports Using Aligner in Multiple Bays

ALIGNER INCLUDES:
Manufacturer's Set-Up and Training

WARRANTY:
1 Year Parts, 6 Months Labor, 30 Days Wheel Clamps



Mobile Tablet Aligner

SKU **OSB**
ROTR1065 **12,589⁹⁹**

- Tablet Operated No PC Required
- Wifi Communication No Cables
- 4 Sensors 2CCD Cameras Each
- Sensor Cart Charging Built-In
- 4 Point Clamps

ALIGNER INCLUDES:
Manufacturer's Set-Up

WARRANTY:
3 Years Parts and 1 Year Labor



GREAT FINANCING PROGRAMS*

UniSource Capital

Never give up...Never Surrender!®

UNISOURCE 800-404-6792

<https://unisourcecapital.com/OnlineApplication.aspx>

NEWLANE FINANCE
BUSINESS LENDING DONE RIGHT™

NEWLANE 267-768-3228

<https://newlanefinance.com/finance-application>

PEAC SOLUTIONS

PEAC 856-505-4450

www.peacsolutions.com

* Financing is provided by third parties who are not affiliates of AutoZone. All of the advertised loan programs, rates, terms and conditions are subject to change at any time without notice. An extra charge may be imposed at the end of the lease depending on the residual value of the leased goods. Free overnight shipping available to continental U.S. for qualifying VDP orders of 70 lb. or less. Free overnight shipping excludes: liftgate fees, residential delivery, non-network carriers, and certain freight intensive items that are shipped FOB.



Customer Responsible For Offloading, Liftgate Service Available.

For OSB, Call 901-300-4878

- Free Delivery in 48 Continental United States
- Specifications Subject to Change without Notice or Liability
- Equipment Lead Times and Shipping May Vary
- Customers Responsible for Offloading Equipment Upon Arrival
- Leasing Terms Available, Ask Your AutoZone® Commercial Sales Manager.

Prices subject to change without notice. Prices do not include applicable taxes, vehicles, tires, rims, installation or optional equipment as shown. Please do not return purchases to the store. For information regarding warranty, repair, or any questions or concerns, call 901-300-4878.

ALIGNMENT

Aligners

geoliner® 770 AC400 Clamps and VIN Reader

SKU OSB
HOFEEWA752BV3 **28,999⁹⁹**

- Lightweight, 3-Camera System Folds to a Compact Size with a Low Center of Gravity, Taking Up Less Floor Space in the Shop and Easily Maneuverable When Needed
- Touchless AC400 Wheel Clamping System (Only the Tire is Contacted), Installed in Seconds with a Single, Fast-Action Adjustment Knob
- Automatic Height Tracking to Provide Optimum Placement of its Advanced XD Targets and Cameras for More Speed and More Accuracy on Every Alignment
- Diagnostic Alignment with "Compensate Warn Alert" Intervention Gets it Right the First Time
- Video Speed Cameras Constantly Monitor Alignments, Providing Information at Every Step
- Unique Camera Beam Design Fits Through a Standard Doorway and Protects Cameras
- Next Generation UI Optimized for the High Volume User
- Highly Accurate and Reliable XD Camera Technology



geoliner® 609 Alignment System

SKU 1350786
HOFEEWA741TH3
16,999⁹⁹

- Groundbreaking User Interface Provides Instant Access to Critical Tasks
- No Calibrations Required
- Designed for a Connected World
- Small Footprint
- Includes: AC200 Clamps

WARRANTY:
1 Year Motor and Parts,
6 Months Labor,
3 Years Circuit Boards,
Pods and Electronics

ALIGNER INCLUDES:
Manufacturer's Set-Up



geoliner® 660 Imaging Wheel Aligner

SKU OSB
HOFEEWA712TH3 **19,999⁹⁹**

- Advanced XD Cameras and Sophisticated Monitoring Algorithms
- Exclusive Dimensioning and Productivity Features
- Patented EZ-TOE – Turn the Front Wheels and Access Difficult Adjustment Points While Still Displaying Centered Toe Readings
- Features Easy-Rolling Casters, Storage for All Attachments and a Fully Enclosed Printer Compartment
- Includes AC200 Clamps, Brake Pedal Depressor, Color Ink-Jet Printer and Steering Wheel Holder

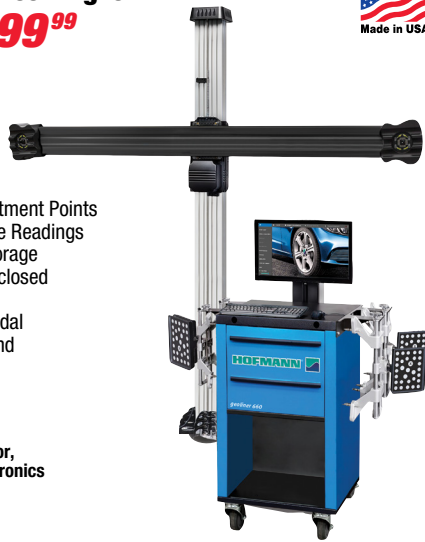

WARRANTY:
1 Year Motor and Parts, 6 Months Labor,
3 Years Circuit Boards, Pods and Electronics

ALIGNER INCLUDES:
Manufacturer's Set-Up

geoliner® 678 Wheel Alignment System with AC400 and VIN

SKU 1350796
HOFA715TBV3 **25,199⁹⁹**

- Easy to Use Interface - 3 Levels of Intervention ("Compensate - Warn - Alert") with Corrective Actions Just One Click Away
- Help Videos - View Detailed Videos of How to Make Needed Adjustments to Complete Even the Most Complex Tasks
- Cross-Diagonal Measurements Identify Frame or Structural Damage (Saving Time)
- Rolling Radius Identifies Mismatched Tire Sizes to Prevent Vehicle Pulling and Drive Train Damage
- Touchless AC400 Wheel Clamping System (Only the Tire is Contacted), Installed in Seconds with a Single Fast-Action Adjustment Knob

WARRANTY:
1 Year Motor and Parts, 6 Months Labor,
3 Years Circuit Boards, Pods and Electronics

ALIGNER INCLUDES:
Manufacturer's Set-Up



Alignment Accessories

Steel Turn Plates

SKU OSB
QSP25-140
Call for Price

- Capacity: 4,500 Lb. per Plate
- Dimensions: 14" x 14" x 1.5"



Stainless Steel Turn Plates

SKU OSB
QSP25-129
Call for Price



Rear Slip Plate Add-On Kit

SKU OSB
QSPDB-6000
Call for Price

- (2) 59-1/2" x 20" Full Floating Rear Slip Plates
- Simple Installation On Most General Service Lifts
- Length Options: 173", 186" to 196" and 200" to 205"
- Turn Plates Not Included



Steering Wheel Holder and Pedal Depressor Kit

SKU 802195
24231 **99⁹⁹**

- Holds Steering Wheel in Position for Alignment Adjustments
- Depresses Brake Pedal for Various Brake Checks Including Brake Lamp Operation
- Simply Hand Squeeze the Actuator to Accomplish Fine Adjustments

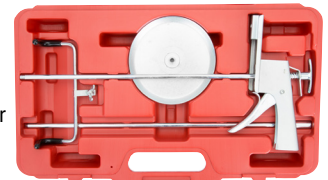

Customer Responsible For Offloading.

For OSB, Call 901-300-4878

- Free Delivery in 48 Continental United States
- Specifications Subject to Change without Notice or Liability
- Equipment Lead Times and Shipping May Vary
- Customers Responsible for Offloading Equipment Upon Arrival
- Leasing Terms Available, Ask Your AutoZone® Commercial Sales Manager.

Alignment Lifts

HOFMANN

12,000 Lb. Scissor Alignment Lift

SKU 1350795
HOFR709APKG

33,399⁹⁹

- Open Front Design Provides Easy Access to Alignment Service and Calibration Areas
- 24" Wide Runways Provide Easy Drive-On for Large Vehicles
- Dual Engaging Twin Interlocking Mechanical Safety Racks with Pneumatic Release
- 95 Second Lifting Time and 45 Second Lowering Time
- 70" Lifting Height

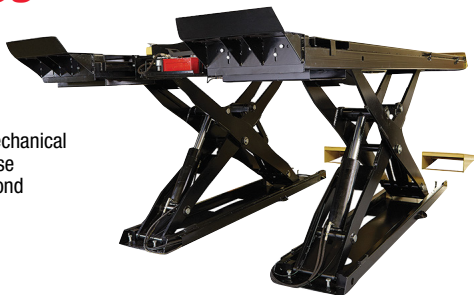

INCLUDES: Rolling Bridge Jacks, Air Line Kit and Turn Plates

WARRANTY:
1 Year Parts and Labor

FORWARD LIFT
"ROTARY"

14,000 Lb. 4 Post Alignment Lift

SKU 568433
FORCRA14

21,039⁹⁹

- Max. Rise: 80-3/4"
- Max. Wheelbase: 182-1/2"
- 4 Wheel Alignment from 88" to 157"
- Long Lasting, High Performance Cable and Sheave System



INCLUDES: Rear Slip Plates, (2) 7,000 Lb. Rolling Jacks, Radius Gauges and Internal Air Line

WARRANTY:
1 Year Parts and Labor

15,000 Lb. 4 Post Open Front Alignment Rack Package - Ext. Length

SKU OSB
CHLAR4115XAO

33,149⁹⁹

- Max. Wheelbase: 210"
- Improved 4-Wheel Alignment Wheelbase with Longer Rear Slip Plates
- Removable Lock without Dropping the Column
- Enclosed Column with No Outside Lubrication
- Improved Column and Cross Beam Design
- Increased Drive Through Clearance
- 26" Wide Runways
- 78" Rise Height



WARRANTY:
2 Year Parts, 1 Year Labor

INCLUDES: Air Line Kit, Slip Plates, Turn Plates and Two Rolling Jacks

CL Challenger Lifts

4 Post Alignment Lift Combo

SKU OSB
BEN14LSXCOMB1

16,079⁹⁹

- 14,000 Lb. Capacity
- Overall Length: 242"
- Runway Width: 20"

SAVE \$592



WARRANTY:
1 Year Parts and Labor

INCLUDES: Air Line Kit, Slip Plates, Turn Plates and Two Rolling Jacks

BendPak

14,000 Lb. Scissor Alignment Lift Package

SKU OSB
AMM8KSC14KITP

45,149⁹⁹

- Max. Service Wheelbase: 198"
- Max. 4 Wheel Alignment Wheelbase: 160"
- Max. 2 Wheel Alignment Wheelbase: 178"
- Ceiling Height Required: 12'
- Overall Length: 260"
- Overall Width: 91-1/2"
- Lifting Height: 74"



COATS

INCLUDES: 2 HD Rolling Jacks, 2 SS Turn Plates, 2 Roll Back Bars and 1 Airline Kit

WARRANTY:
1 Year Parts and 6 Months Labor

15,000 Lb. 4 Post Open Front Ext. Alignment Lift Pkg

SKU OSB
AMM8K4P15XKITP

41,049⁹⁹

- Max. 4 Wheel Alignment Wheelbase: 164-1/2"
- Max. 2 Wheel Alignment Wheelbase: 209"
- Ceiling Height Required: 12' Raised Height: 75"
- Overall Length: 287-1/2"
- Overall Width: Front 143" to Rear 137-1/2"



COATS

INCLUDES: 2 HD Rolling Jacks, 2 SS Turn Plates, 2 Roll Back Bars and 1 Airline Kit

WARRANTY:
1 Year Parts and 6 Months Labor



Customer Responsible For Offloading.

For OSB, Call 901-300-4878

• Free Delivery in 48 Continental United States • Specifications Subject to Change without Notice or Liability • Equipment Lead Times and Shipping May Vary • Customers Responsible for Offloading Equipment Upon Arrival • Leasing Terms Available, Ask Your AutoZone® Commercial Sales Manager.

Prices subject to change without notice. Prices do not include applicable taxes, vehicles, tires, rims, installation or optional equipment as shown. Please do not return purchases to the store. For information regarding warranty, repair, or any questions or concerns, call 901-300-4878.

For Pricing, Call your Commercial Sales Manager

Heavy Equipment

Call for price

PSB-SDD26B-3PH-230V-AK

Side Down Paint Booth

SKU 592190

- Inside Dimensions 26' L X 14' W X 9'3"H
- 5/16" Bolt & Nut Assembly
- 18 Gauge Panels
- UL Listed Dayton 24" Tube-Axial Fan



Single and 3 phase available
Ask about our other PB options!

Call for price

MSC-18K-X-472

ALI Certified Mobile Columns

SKU 000942100

- 72,000lb Capacity
- 24VDC Battery Operation w/ Onboard Charging System
- Synchronized Operation
- Independent Locking Systems



Ask about our other mobile column options!

Call for price

Two Post Lifts

TP11KC-DX

11,000lbs CAPACITY
SKU 426140

- Direct "Pull" Cylinders
- Overall Height: 145"
- Overall Width: 145-1/2"
- 3 Stage Front Arms,
- Low Profile Arms
- Rubber Door Guards
- Spin Up Pads with stackable drop in Height Adapters



8G DRAIN
8 Gallon Drain
SKU 426733

TP9KACX

9,000lbs CAPACITY
SKU 426138

- Asymmetric Arms
- Overall Height: 143"
- Overall Width: 138"
- Spin Up Pads with stackable drop-in height adapters



Floorplate Options Available!

Alignment Combo

CK-14KACX-IWA *Call for price*

iDEAL Alignment Lift & Wheel Aligner Combo Bundle Kit

SKU: 429041

- High Performance Commercial Alignment Lift
- Durable, High Quality Cable Lift System
- Extended Rise Height
- 'Bolt-On' Runway Alignment Kit
- 18 Locking Height Positions
- 20" Wide Runways
- Slack Cable Safety Devices



Combo Bundle Kit Includes:

- (1) FP14KAC-X Alignment Lift
- (1) Airline Kit
- (1) Set of Turntables w/ Rollback Spacers
- (2) RAJ-7K-H Bridge Jacks
- (1) IAW-60-2000T-K iPRO Wheel Aligner

Single Column

MSC-6KLP

iDEAL Mobile Single Column Lift
SKU 000426460

- 6,000 lbs Capacity
- Low Profile Design
- Portable
- Single Point Lock Release
- 21 Locking Positions
- Stackable Height Extensions Included



Wheel Service

TC-950/WB953 *Call for price*

Tire Changer & Wheel Balancer Combo
SKU 000880175

- Max Wheel Diameter: 39"
- Rim Width: 1.5" - 20"
- Rim Diameter: 10" - 24"
- Wheel Weight Capacity: 150 lbs

- Max Wheel Diameter: 47"
- Rim Width: 3" - 15"
- Rim Diameter: 15" - 28"



WW-BASIC
Basic Wheel Weight Kit
SKU 000426813

Call for price

Storage Lifts

FP8K-DX-XLT

8,000lbs CAPACITY
SKU 426415

- Extended Lift Height & Length
- Cable Driven Lifting System
- Single Point Manual Lock Release
- Slack Cable Safety
- Steel Approach Ramps
- Adjustable Locking Postitions



Also available in 9,000lb Capacity!

SP-6K-SS

6,000lbs CAPACITY
SKU 000426416

- 6,000lb Capacity
- Low Post Height for Low Ceilings
- Low Profile Ramps
- Ability to install on Right or Left Side
- Single Point Lock Release



Call for price

• Free Delivery in 48 Continental United States • Equipment Lead Times and Shipping May Vary
• Customer is Responsible for Offloading Equipment Upon Arrival

AUTOMOTIVE LIFTS

FOR HELP with Selection, Confirm Availability and Ordering Instructions, Call 901-300-4878

AUTOMOTIVE LIFTS

Challenger Lifts

10,000 Lb. 2 Post Offset Arm Design Lift

SKU OSB CHLVLE10 **5,739⁹⁹**

Versymmetric[®] 3-Stage Offset Front Arms

- Lifts Asymmetric and Symmetric in the Same Service Bay
- Rubber Door Guards



Versymmetric[®] Technology

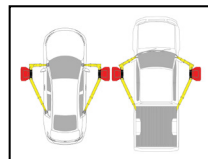

Available in Red and Blue



INCLUDES: Telescoping Footpads

WARRANTY: 1 Year Parts and Labor

10,000 Lb. 2 Post Versymmetric[®] Adjustable Lift

SKU 1544683 CHLCL10AV3 **7,724⁹⁹**

3-Stage Front, 3-Stage Rear Arms with Swept Arm Design

- 3 Adjustable Widths and 2 Adjustable Heights
- Can Be Set Up to Lift Most EVs
- Arm Reach: Front - Min. 20", Max. 42" Rear - Min. 37-5/8", Max. 60"
- Ceiling Height Required: 12' Minimum
- Width: 14' Recommended



Versymmetric[®] Technology

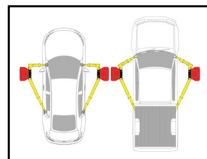

Available in Red, Blue and Black



INCLUDES: Telescoping Footpads

WARRANTY: 2 Years Parts and 1 Year Labor

12,000 Lb. 2 Post Symmetric Lift

SKU 1580894 CHLLE12-3S **9,729⁹⁹**

- Heavy Duty 3-Stage Front and Rear Arms
- Single-Point Mechanical Lock Release
- Adjustable Column Height: 166" or 175"
- Padded Overhead Shut-Off System
- Powder Coat Finish
- Standard Dual Integrated Rubber Door Guards
- Includes: (4) 3" Stack Extensions, (2) 6" Stack Extensions and (2) Organizer Racks with Hardware



Available in Red and Blue

WARRANTY: 1 Year Parts and Labor

12,000 Lb. 2 Post Symmetric Lift

SKU OSB CHLCL12A **11,724⁹⁹**

- 3-Stage Front and Rear Arms Provide Extension and Retraction to Lift Everything from Small Sedans to Pickup Trucks
- Adjustable Height: 158" to 164"
- Adjustable Width: 142"/148"/154"
- Includes 10315 Stack Adapter Kit, (4) 3" Stack Adapters, (2) 6" Stack Adapters, (2) Organizer Racks with Hardware



Available in Red, Blue and Black

WARRANTY: 2 Year Parts, 1 Year Labor

14,000 Lb. 4 Post Closed Front Lift

SKU 851781 CHL4P14EFX **10,399⁹⁹**

- 20" Wide Runways
- Max. Wheelbase: 182.5"
- Minimum Bay Size: 12' x 24'
- Rise Height: 78"
- Color: Black Only



Air Line Kit
SKU 1580944 CHL40230E **744⁹⁹**



WARRANTY: 1 Year Parts and Labor
Rolling Jacks Sold Separately

One 7,500 Lb. Rolling Jack

SKU 264847 CHLRJ75 **4,524⁹⁹**



Optional Equipment

WORKS WITH



BEFORE PLACING YOUR AUTOMOTIVE LIFT ORDER:

Please verify minimum ceiling height, concrete requirements and bay size. See page 2 for delivery information or **Call 901-300-4878.**

Quality Lifts

quality lifts

10,000 Lb. 2 Post Lift

SKU 1580947 CHLEQ10 **4,999⁹⁹**

- 3-Stage Front, 2-Stage Rear Arms
- Lifts Symmetrically or Asymmetrically
- Ceiling Height Required: 12'
- Rubber Door Guards
- Padded Overhead Shut-Off Bar
- Single-Point Lock Release System
- Color: Black Only



INCLUDES: (4) 3" Stack Adapters and Drop-In Footpads

WARRANTY: 6 Months Parts and Labor

UPGRADE YOUR QUALITY LIFT

Double Telescoping Footpads (4 Pack)

SKU 1580892 CHLB2270PK4 **599⁹⁹**

- 10,000 Lb. Footpads
- Fits Quality 10,000 Lb. 2 Post Lifts
- Single Pad Features Frame Engaging Ears



(2) 6" Stack Adapters

SKU 263307 CHL10313 **251⁹⁹**

- Upgrade for CHLEQ10 Lift



12,000 Lb. 2 Post Heavy Duty Lift Screw-Style Footpad

SKU 1580890 CHLB12162S-12 **104⁹⁹**

- Fits Challenger and Quality 12,000 Lb. Heavy Duty 2 Post Lifts
- Single Pad Features Frame Engaging Ears



Customer Responsible For Offloading.

For OSB, Call 901-300-4878

- Free Delivery in 48 Continental United States
- Specifications Subject to Change without Notice or Liability
- Equipment Lead Times and Shipping May Vary
- Customers Responsible for Offloading Equipment Upon Arrival
- Leasing Terms Available, Ask Your AutoZone[®] Commercial Sales Manager.

Prices subject to change without notice. Prices do not include applicable taxes, vehicles, tires, rims, installation or optional equipment as shown. Please do not return purchases to the store. For information regarding warranty, repair, or any questions or concerns, call 901-300-4878.

AZG0326

AUTOMOTIVE LIFTS

Coats Lifts

10,000 Lb. 2 Post Lift with 3 Stage 2N1 Arms

SKU 912314
AMM4TV21NSR1 **8,249⁹⁹**

- 90" Offset 3-Stage Front and Rear Arms for Asymmetric or Symmetric Vehicle Positioning
- Includes: Door Bumper Guards and Lifting Adapters
- Premium U.S. Made Power Unit
- Overall Height: 138" or 148"



WARRANTY:
1 Year Parts, 6 Months Labor

12,000 Lb. 2 Post Lift with 3 Stage Symmetric Straight Arms

SKU OSB
AMM4T212SSR1 **10,999⁹⁹**

- Includes: Door Bumper Guards and Lifting Adapters
- Overall Width: 137-1/8"
- Overall Height: 154-7/8" or 158-7/8"
- Color: Red



12,000 Lb. 2 Post Lift with 3 Stage 2n1 Arms

SKU 765526
AMM4T212NSR1 **10,999⁹⁹**

WARRANTY: 1 Year Parts, 6 Months Labor

Forward Lifts

10,000 Lb. F10 2 Post Lift

SKU OSB
FORF10N500MBK
5,799⁹⁹

- 3-Stage Front Arms and Two-Stage Rear Arms
- Includes: Drop In Adapters and 4 Extensions
- Overall Height: 141"
- Color: Black



INCLUDES:
Truck Adapters

WARRANTY:
1 Year Parts and Labor

110 10,000 Lb. 2 Post Lift

SKU 499657
FOR110 **6,234⁹⁹**

- Smooth Lifting and Long Life with Forward's Direct Pull Cylinders
- Spot-Rite™ 3-Stage Front Arms, 2-Stage Rear Arms
- 76-1/4" Rise
- Available in Black Only



INCLUDES:
Truck Adapters

WARRANTY:
1 Year Parts and Labor

112 Symmetrical Two Post Lift 12K Capacity

SKU OSB
FOR112N300BK
10,729⁹⁹

- 3-Stage Front and Rear Arms
- Includes: Drop-In Adapters with 4 Extensions
- Overall Height 166"
- Color: Black



INCLUDES:
Truck Adapters

WARRANTY:
1 Year Parts and Labor

14,000 Lb. CR14L 4 Post Lift

SKU 215514
FORCR14L **8,359⁹⁹**

- Heavy Duty Hydraulic Cylinder
- Single Point Latch Release System
- 78-3/4" Rise
- 18 Lock Positions
- Accommodates 182-1/2" Wheelbase Vehicles
- High Performance Cable and Sheave System



Internal Air Line Kit

SKU OSB
ROTFC5760-14
699⁹⁹

Rolling Jacks Sold Separately
WARRANTY:
1 Year Parts and Labor

One 7,000 Lb. Rolling Jack

SKU 568445
FORRRJ70G **4,499⁹⁹**



Two 7,000 Lb. Rolling Jacks

SKU 434708
FORRRJ70GBOGO **6,749⁹⁹**

Optional Equipment

Offer Valid Only with Purchase of Forward 4 Post Lift

Rotary Lifts

10,000 Lb. 2 Post Asymmetric Lift with AV Arms - Blue

SKU 1580893
ROTSPA10AVBL **8,479⁹⁹**

- Easy Spotting and Positioning
- Highest Capacity Low-Profile Lift Available
- Comes Standard with Adjustable Round, Truck and Stackable Adapter Extensions
- Overall Width: 11' 5-1/2"
- Overall Height: 11' 11-1/2"
- Arm Reach: Front: Min. 18-1/2" - Max. 41", Rear: Min. 27-5/8" - Max. 58-1/4"
- Max Rise: 81-1/2"
- Drive-Thru Clearance: 95-1/4"
- Min. Bay Size: 12' x 24'

WARRANTY: 1 Year Parts and Labor



Shown with Additional Accessories

14,000 Lb. 4 Post Lift

SKU 210366
ROTSM14L **11,989⁹⁹**

- Filter/Regulator/Lubricator Included to Extend the Life of Lift and Tools
- Max. Wheel Base: 182"
- 78" Rise
- Long Lasting Cables and Sheaves

Rolling Jacks Sold Separately

Internal Air Line Kit

SKU OSB
ROTFC5760-14
699⁹⁹



WARRANTY:
1 Year Parts and Labor

WORKS WITH

One 7,000 Lb. Rolling Jack

SKU OSB
ROTRJ7100Y **5,649⁹⁹**

Optional Equipment



Customer Responsible For Offloading.

For OSB, Call 901-300-4878

- Free Delivery in 48 Continental United States
- Specifications Subject to Change without Notice or Liability
- Equipment Lead Times and Shipping May Vary
- Customers Responsible for Offloading Equipment Upon Arrival
- Leasing Terms Available, Ask Your AutoZone® Commercial Sales Manager.

AUTOMOTIVE LIFTS

FOR HELP with Selection, Confirm Availability and Ordering Instructions, Call 901-300-4878

AUTOMOTIVE LIFTS

BendPak® Lifts

10,000 Lb. 2 Post Lifts

- Bi-Metric™ Reversible Triple Telescoping Swing Arms
- Low-Pro™ Swing Arms
- Automatic Arm Restraints
- Expandable Top Beam Accommodates Wide or Narrow Drive-Thru Configurations

SKU 1360698 | BEN10AP

6,099⁹⁹

- Height: 145"
- Width: 135" to 145"
- Rise: 69"



BEN10AP

SKU OSB
BEN10APX

6,899⁹⁹

- Height: 157"
- Width: 135" to 145"
- Rise: 75.5"

SKU OSB
BEN10AP-168

6,599⁹⁹

- Height: 168"
- Width: 135" to 145"
- Rise: 69"

SKU OSB
BEN10APX-181

7,499⁹⁹

- Height: 181"
- Width: 135" to 145"
- Rise: 75.5"

- 24" Bolt-On Extension for Increased Vehicle Height Clearance

- 24" Bolt-On Extension for Increased Vehicle Height Clearance

WARRANTY: 1 Year Parts and Labor

BendPak®

12,000 Lb. 2 Post Bi-Metric™ Lift

SKU OSB
BEN12APX **9,919⁹⁹**

- Adaptable Design: Symmetric or Asymmetric
- Automatic Swing Arm Restraint System
- Includes: 4 Frame Cradle Pads, 4 Medium and 4 Tall Stacking Adapters



12,000 Lb. 2 Post Short-Rise Floorplate Lift

SKU OSB
BEN12AP-SRT

8,789⁹⁹

- Post Height: 93.5"
- Max. Lifting Height: 46"

Great Choice for Low Ceiling Height Where You Do Not Need to Work Underneath the Vehicle



INCLUDES: 4 Frame Cradle Pads, 4 Medium and 4 Tall Stacking Adapters



WARRANTY: 1 Year Parts and Labor

16,000 Lb. 2 Post Lift

SKU OSB
BEN16AP **22,699⁹⁹**

- Telescoping Arms Accommodate a Wide Variety of Vehicle Chassis
- Dual Direct-Drive Hydraulic Cylinders for Smoother Operation and Less Maintenance
- Includes: 4 Frame Cradle Pads, 4 Medium and 4 Tall Stacking Adapters with Column-Mounted Racks



INCLUDES: 4 Frame Cradle Pads, 4 Medium and 4 Tall Stacking Adapters



WARRANTY: 1 Year Parts and Labor

10,000 Lb. Low-Rise Lift

SKU 1275473
BENLR-10000 **5,499⁹⁹**

- Min. Height: 4.5"
- Max. Lift Height: 23"
- Lift Height + Blocks: 32"



4.5" to 32" ↑↓

WARRANTY: 1 Year Parts and Labor

7,000 Lb. Full-Rise Scissor Lift

SKU OSB
BENSP-7XE **10,799⁹⁹**

- Full-Rise Scissor Design Provides Clear Access
- Open-Center Platform Ideal For Exhaust, Transmission, And Brake Work
- Ultra-Low Profile For Easy Drive-On and Drive-Off
- 68" Rise Height, 84" Overall Length, 78.5" Overall Width, 63" Platform Length, 21" Platform Width, 220V, 1-Phase Power



WARRANTY: 1 Year Parts and Labor

6,000 Lb. Low-Rise Pad Lift

SKU 210383
BENLR-60 **3,499⁹⁹**

- Min. Height: 3.5"
- Max. Lifting Height: 23"
- Max. Lift Height + 1.5" Blocks: 24.5"



3.5" to 24.5" ↑↓

WARRANTY: 1 Year Parts and Labor

Portable
SKU 210384
BENLR-60P

3,599⁹⁹

- Min. Height: 4"
- Max. Lifting Height: 23"



Customer Responsible For Offloading.

For OSB, Call 901-300-4878

- Free Delivery in 48 Continental United States
- Specifications Subject to Change without Notice or Liability
- Equipment Lead Times and Shipping May Vary
- Customers Responsible for Offloading Equipment Upon Arrival
- Leasing Terms Available, Ask Your AutoZone® Commercial Sales Manager.

Prices subject to change without notice. Prices do not include applicable taxes, vehicles, tires, rims, installation or optional equipment as shown. Please do not return purchases to the store. For information regarding warranty, repair, or any questions or concerns, call 901-300-4878.

AZG0326

AUTOMOTIVE LIFTS

BendPak® Lifts

14,000 Lb. 4 Post Lift

SKU 898152
BENHDS14

8,129⁹⁹

- Overall Width: 130"
- Overall Length: 241"
- Max. Rise: 70"
- Motor: 220 VAC/1 Ph



Air Line Kit

SKU 531175
BEN5174009

132⁹⁹

Shown with Optional Equipment
Rolling Jacks Sold Separately
WARRANTY: 1 Year Parts and Labor

WORKS WITH

One 7,000 Lb. Capacity Rolling Bridge Jack

SKU OSB
BENRJ7W **2,459⁹⁹**



Optional Equipment

9,000 Lb. 4 Post Lift

SKU 898142
BENHD-9

6,099⁹⁹

- Overall Width: 110.25"
- Overall Length: 174"
- Column Height: 88" (2,235 mm)
- Max. Lifting Height: 74-1/2" (1,892 mm)



Air Line Kit

SKU 531175
BEN5174009

132⁹⁹

Shown with Optional Equipment
Rolling Jacks Sold Separately
WARRANTY: 1 Year Parts and Labor

WORKS WITH

One 4,500 Lb. Capacity Rolling Bridge Jack

SKU 1275497
BENRJ45W **2,359⁹⁹**



Optional Equipment

Atlas Equipment

Commercial Grade Overhead 2 Post Lift 15,000 Lb. Capacity

SKU OSB *Call for Price*
ATLXH-PV15PX-FPD

- Extra Tall and Extra Wide
- Adjustable Height: 165" (13' 9") or 177" (14' 9")
- Special Low Height: 150" (12' 6") (Requires Purchase of Extra Cables)
- Symmetric Arms



WARRANTY: 2 Years Parts Only

Heavy Duty Truck Wheel Balancer

SKU OSB *Call for Price*
ATLATWBT-210-FPD

- Computer Controlled Heavy Duty Spin Balancer
- Plastic Quick Release Nut and Heavy Duty Steel Wing Nut Included
- Pneumatic Wheel Lift (External Air Supply Required - Not Included)
- Automatic Start/Stop When Hood is Lowered/Raised
- Static and Dynamic Balancing Modes
- Includes: Cone Sets for Car and Light Truck Tires
- Includes: Cone and Spacer Set for Truck, Bus, or Implement Tires



WARRANTY: 1 Year Parts Only

14,000 Lb. 4 Post Lift

SKU OSB *Call for Price*
ATLAP-PVL14-FPD

- Lifting Height: 76-1/2"
- Clearance Under Runways: 69-1/2"
- Width of Columns (with Motor): 140-1/2"
- Length with Approach Ramp: 251-1/2"
- Runway Width: 20"
- Rolling Jacks Sold Separately



WARRANTY: 2 Years Parts Only

12,000 Lb. Heavy Duty 2 Post Lift

SKU OSB *Call for Price*
ATLXH-PV12PXFDP

- Adjustable Height: 165" (13' 9") or 177" (14' 9")
- Special Low Height: 150" (12' 6") (Requires Purchase of Extra Cables)
- Symmetric Arms
- Automatic Arm Restraints

WARRANTY: 2 Years Parts Only

12,000 Lb. 2 Post Lift

SKU OSB *Call for Price*
ATLAP-PVL12-FPD

- Low Pad Height Allows Lift to Accommodate Both Long Wheelbase Trucks and Passenger Cars
- Extra Tall and Extra Wide
- 3-Stage Symmetric Arms
- 8 Piece Truck Adapter Set

WARRANTY: 2 Years Parts Only



Customer Responsible For Offloading.

For OSB, Call 901-300-4878

- Free Delivery in 48 Continental United States
- Specifications Subject to Change without Notice or Liability
- Equipment Lead Times and Shipping May Vary
- Customers Responsible for Offloading Equipment Upon Arrival
- Leasing Terms Available, Ask Your AutoZone® Commercial Sales Manager.

AUTOMOTIVE LIFTS

FOR HELP with Selection, Confirm Availability and Ordering Instructions, Call 901-300-4878

AUTOMOTIVE LIFTS

Mid-Rise Lifts

BendPak

6,000 Lb. Portable Mid-Rise Lift

SKU 210386
BENMD-6XP **3,599⁹⁹**

- Portable, Easy to Move from Bay to Bay
- Adjustable Arms



INCLUDES:
Truck Adapters

WARRANTY:
1 Year Parts and Labor

CL Challenger Lifts

6,000 Lb. Mid-Rise Portable Lift

SKU 1580897
CHLMR6 **4,049⁹⁹**

- 6 Safety Lock Positions
- Short and Tall Auxiliary Adapters Come Standard
- Sliding/Rotating Arm Design Reaches Pick-Up Points on a Wider Range of Vehicles
- Zerk Fittings on Pivot Points for Serviceability



WARRANTY:
1 Year Parts and Labor

CL Challenger Lifts

10,000 Lb. Short Rise Lift

SKU 264857
CHLSRM10 **6,134⁹⁹**

- Min. Height: 4.25"
- Max. Height: 22"
- Includes: (4) 2 Position Adapter Blocks
- Three Locking Positions for Ease of Use
- Color: Black Only

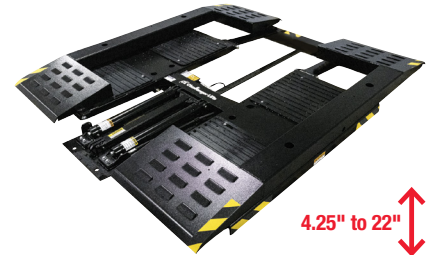

WARRANTY:
1 Year Parts and Labor

MaxJax Lift

MAXJAX

MaxJax M7K

SKU 1360718
MJXM7K **5,199⁹⁹**

- Min. Pad Height: 5.5"
- Height Overall: 89.5"
- Max. Lift Height: (Pad Only) 47.25" (With 3" Adapter) 50.5"
- Clear Undercar Access
- Portability
- Stow to Go in Less Than 15 Minutes



WARRANTY: 1 Year Parts and Labor

QuickJack™ Lifts

QUICKJACK™

You get it all.

- Complete Package Includes: 2 Jack Frame Assemblies, (2) 150" Hydraulic Hoses, (2) 14" Aux. Hoses, 2 Quick-Mount Handles, (4) 1.5" x 3" x 4" Rubber Lifting Blocks, (4) 3" x 3" x 4" Rubber Lifting Blocks, 1 Mini Hydraulic Power Unit with Pendant Control



8000TLX Extended-Length Portable Truck and SUV Lift

SKU OSB
QJK8000TLX **2,159⁹⁹**

- Capacity: 8,000 Lb.
- 66" Lift Point Reach
- Fast and Easy Setup
- Stackable Rubber Blocks
- Automatic Safety Locks
- Increased Lifting Height
- Undercarriage Access
- One Handed Operation



QuickJack™ SUV and Light Truck Adapters

SKU 862288
RAN5150561 **249⁹⁹**

- Fits BL-5000 and BL-7000 Series
- Set of 12 Pieces Includes: 4 Low Profile Round Polyurethane Contact Pads, 4 Sliding Receivers That Accommodate the Round Polyurethane Contact Pads and (4) 3" Stackable Adapters



Motorcycle Lift

OEM TOOLS

Air Hydraulic Motorcycle Lift 1,000 Lb. Capacity

SKU 662742
24859 **1,199⁹⁹**

- Our Lift Compares to Top Brand Motorcycle Lifts in Every Way
- 86.5" x 26.75" Platform Deck with 25.5" Long Removable Loading Ramp
- Built-In Casters and Adjustable Stabilizers
- Durable 12 Gauge, Powder Coated Diamond Plate Deck
- Air/Hydraulic Lift System Allows Use with Shop Air or as a Manual Lift
- Tie Down Rings on Deck for Added Stability



Heavy Duty, Positive Stop, Padded Wheel Vise

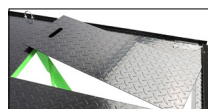

Rear Dropout Panel (for Rear Tire Maintenance Access)



Customer Responsible For Offloading.

For OSB, Call 901-300-4878

- Free Delivery in 48 Continental United States
- Specifications Subject to Change without Notice or Liability
- Equipment Lead Times and Shipping May Vary
- Customers Responsible for Offloading Equipment Upon Arrival
- Leasing Terms Available, Ask Your AutoZone® Commercial Sales Manager.

Prices subject to change without notice. Prices do not include applicable taxes, vehicles, tires, rims, installation or optional equipment as shown. Please do not return purchases to the store. For information regarding warranty, repair, or any questions or concerns, call 901-300-4878.

AZG0326

95

AUTOMOTIVE LIFTS

Lift Pads



Forward/Eagle/Gemini/Worth/American Hexagon Shaped - 2 Bolt Style Lift Pads (Set of 4)

SKU 1137807 **89⁹⁹**
SHA51663

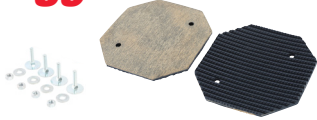

Fits Models

I-DP9, DP09A2, DP09A, DP07A, DP97A, DP7A, Eagle and Other Texas Style 2 Post Lifts

Replaces

OEM# 994105, 991234, 991222 and LP603

Hexagon Shaped - 2 Bolt Style Lift Pads (Set of 4)

SKU 1137812 **119⁹⁹**
SHA51661



20000, 21000, 26000, 27000, 28000, 30000, 31000, 33000, 36000, 37000, 39000

OEM# JOK01D, LP602

Challenger Rubber Round Slip-On Lift Pad (Single)

SKU 477103 **23⁹⁹**
CHLB2208



Challenger CL10, E10, Q10, VS10 and Ammco AC21NS

N/A

Quality Round Slip-On Lift Pads (Set of 4)

SKU 1137816 **54⁹⁹**
SHA51673



VS10, CI10, E10, TLT210, TLT210-AS, TLT211, TLT211-AS, ACD210S and More

OEM# 104130315, B2208

Rotary Square Bolt Style Lift Pads (Set of 4)

SKU 1137817 **114⁹⁹**
SHA51667



SPO9, SPOA9, SPO10, SPOA10, SPO12, SI29, SL19, SL210

OEM# FJ6213, BH-7536-92P, BH7542-73 and LP609

BendPak Square Slip-On Lift Pads (Set of 4)

SKU 1137805 **129⁹⁹**
SHA51666

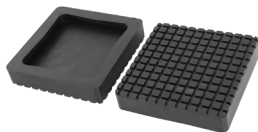

MX10AC, MXACX, X10CX, MX10C, XPR-9S, XPR-9S-LP, XPR-9DS, XPR-10S, XPR-10S-LP, XPR-10S-168, XPR-10AS, XPR-10AS-LP, XPR-10AS-168, XPR-12FDL, XPR-12CL, XPR-15CL, XPR-18CL, XPR-12CL-192, XPR-15CL-192, XPR-18CL-192, RJ6, RJ6000, RJ4500

OEM# 5715-365 and LP608

Challenger



Electric Vehicle Footpad (Set of 4)

SKU 1544676 **809⁹⁹**
CHLEVPK

- Designed Specifically to Work on Electric Vehicles
- Fits All 10K and 12K 2 Post and Inground Lifts
- Double-Screw-Up for Finer Adjustments
- Low Profile, Fits in Small Places
- Durable, Thin Pad

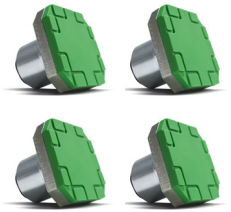

Truck Adapter Set for 10,000 Lb. and 12,000 Lb. 2 Post Lifts

SKU 263557 **613⁹⁹**
CHL10315

- Stack Adapter Extension Kit Includes: (4) 3" Stack Extensions, (2) 6" Stack Extensions and 2 Organizer Racks with Hardware



GM Wide Frame Footpads (Pair)

SKU 477079 **759⁹⁹**
CHLB2280PR

- Fits 2008 and Up Challenger Lifts CL10V3, E10, LE10, VLE10, SA10, CLFP9, E12, CL12 and EV1020 Models
- Works on 2019 GMC Sierra and Chevrolet Silverado Half-Ton Trucks
- Drop-In Design Makes Switching Simple and Quick
- Telescoping Feature Provides Simple Access to Lift Points



BendPak

Rubber 2 Post Lift Pad/Slip Over (Set of 4)

SKU 954179 **83⁹⁹**
BEN5700227

- Heat and Cold Resistant
- Highly Resistant to Gouging
- Oil and Solvent Resistant
- Tear Resistant



Lift Pad Assembly/ 35 mm Pin (Set of 4)

SKU 1053947 **204⁹⁹**
BEN5215753

- Works with Any BendPak 2 Post Lift
- Thick Rubber Construction
- Textured Surface for Extra Grab
- Will Not Scratch the Vehicle
- Easy Drop-In Design
- 5" Diameter for Enhanced Stability



Cradle Pads

- Tactile Rubber Pad Reduces Slippage and Protects the Finish
- Made for Heavy Duty Commercial-Grade Trucks
- Installs Easily to BendPak 2 Post Lift Arms
- Sturdy Steel Construction

Frame Cradle Pads 35 mm Pin (Set of 4)

SKU 954221 **216⁹⁹**
BEN5215754



Wide Frame Cradle Pads 60 mm (Set of 2)

SKU 979067 **196⁹⁹**
BEN5215848



2-POST LIFTS

APEX
by BendPak

NEW!

**AL9LC 9,000 lb.
Floorplate 2-Post Lift**
SKU OSB APEAL9LC

\$3,929⁹⁹
FREE SHIPPING!*

- Max. Rise - 70"
- Overall Height - 109.5"
- Overall Width - 137.25"



**AL10C 10,000 lb.
Clearfloor 2-Post Lift**
SKU OSB APEAL10C

\$4,199⁹⁹
FREE SHIPPING!*

- Max. Rise - 70"
- Overall Height - 148"
- Overall Width - 137.25"



**9APF 9,000 lb.
Floorplate 2-Post Lift**
SKU OSB BEN9APF

\$6,299⁹⁹
FREE SHIPPING!*

- Max. Rise - 70"
- Overall Height - 123"
- Overall Width - 136" or 146"

BendPak



2-POST LIFTS

**10AP 10,000 lb. Clearfloor
2-Post Lift**
SKU 1360698 BEN10AP

\$6,099⁹⁹ FREE SHIPPING!*

- Max. Rise - 69"
- Height - 145" / Width - 135" - 145"

**10APX 10,000 lb. Clearfloor
2-Post Lift / High-Rise**
SKU OSB BEN10APX

\$6,899⁹⁹ FREE SHIPPING!*

- Max. Rise - 76.5"
- Height - 157" / Width - 135" - 145"

**10AP-168 10,000 lb. Clearfloor
2-Post Lift / Extended Height**
SKU OSB BEN10AP-168

\$6,599⁹⁹ FREE SHIPPING!*

- Max. Rise - 69"
- Height - 168" / Width - 135" - 145"

**10APX-181 10,000 lb. Clearfloor
2-Post Lift / High-Rise / Ext. Height**
SKU OSB BEN10APX-181

\$7,499⁹⁹ FREE SHIPPING!*

- Max. Rise - 76.5"
- Height - 181" / Width - 135" - 145"



24" Column Extension
Included on 168 & 181 Models

BendPak



FEATURES
AUTOMATIC SWING ARM
RESTRAINT SYSTEM™



360° ASARS

2-POST LIFTS

**12APX 12,000 lb. Clearfloor
Super-Duty 2-Post Lift**
SKU OSB BEN12APX

~~\$10,495~~ **\$9,919⁹⁹**
FREE SHIPPING!*

- Max. Rise - 76"
- Height - 169" / Width - 156"

**12APX-192 12,000 lb. Clearfloor
Super-Duty 2-Post Lift / Ext. Height**
SKU OSB BEN12APX-192

\$10,869⁹⁹ FREE SHIPPING!*

- Max. Rise - 76.5"
- Height - 193" / Width - 156"



INCLUDES
Frame Cradle Pads Med. & Tall Adapters

2-POST LIFTS

**16AP-192 16,000 lb. Clearfloor
Super-Duty 2-Post Lift / Ext. Height**
SKU OSB BEN16AP-192

\$23,799⁹⁹ FREE SHIPPING!*

- Max. Rise - 76"
- Height - 193" / Width - 168"

**20AP-192 20,000 lb. Clearfloor
Super-Duty 2-Post Lift / Ext. Height**
SKU OSB BEN20AP-192

\$25,599⁹⁹ FREE SHIPPING!*

- Max. Rise - 76.5"
- Height - 193" / Width - 168"



INCLUDES
Frame Cradle Pads Med. & Tall Adapters

ALIGNMENT COMBOS

HDS-14LSX Combo Deal
SKU OSB BEN14LSXCOMB1

~~\$16,073~~ **\$16,079⁹⁹**
FREE SHIPPING!*

- INCLUDES:**
- (1) HDS-14LSX Closed-Front 4-Post Alignment Lift
 - (1) Airline Kit
 - (2) RJ7W Rolling Jacks

HDS14LSX Specs:

- Capacity - 14,000 lbs.
- Max. Rise - 70"
- 130" (W) / 242" (L)

SAVE BIG!

HDS-14LSXE Combo Deal
SKU OSB BEN14LSXECMB2

~~\$17,433~~ **\$16,629⁹⁹**
FREE SHIPPING!*

- INCLUDES:**
- (1) HDS-14LSXE Closed-Front 4-Post Alignment Lift
 - (1) Airline Kit
 - (2) RJ7W Rolling Jacks

HDS14LSXE Specs:

- Capacity - 14,000 lbs.
- Max. Rise - 70.75"
- 130" (W) / 272" (L)

SAVE BIG!

HDSO-14AX Combo Deal
SKU OSB BEN14AXCOMB3

~~\$18,033~~ **\$17,759⁹⁹**
FREE SHIPPING!*

- INCLUDES:**
- (1) HDSO-14AX Open-Front 4-Post Alignment Lift
 - (1) Airline Kit
 - (2) RJ7W Rolling Jacks

HDSO-14AX Specs:

- Capacity - 14,000 lbs.
- Max. Rise - 77.5"
- 143.25" (W) / 244.5" (L)

SAVE BIG!



**HDSO-14AX
Open-Front
Alignment Lift**

*Free shipping to direct shipping points within the 48 contiguous states (excluding surcharges).

Special Pricing Good Through September 30, 2026

Prices subject to change without notice. Prices do not include applicable taxes, vehicles, tires, rims, installation or optional equipment as shown. Please do not return purchases to the store. For information regarding warranty, repair, or any questions or concerns, call 901-300-4878.

TIRE CHANGERS

R76ATR Tilt-Back Power Assist
SKU 544543
RANR76ATR

\$7,399⁹⁹

HOT DEAL

- Int. Clamping - 10" - 30"
- Ext. Clamping - 10" - 16"



FREE SHIPPING!*

R980DP Swing-Arm Dual Assist Tire Changer
SKU OSB RANR980DP

\$7,799⁹⁹

FREE SHIPPING!*

Ranger

- Int. Clamping 10" - 30"
- Ext. Clamping 9" - 26"



HOT DEAL

R80EX Dual-Assist Tilt-Back Tire Changer
SKU OSB RANR80EX

\$11,099⁹⁹

FREE SHIPPING!*

- Int. Clamping 13" - 34"
- Ext. Clamping 10" - 30"



R26FLT Heavy-Duty Tire Changer
SKU 544552 RANR26FLT

HEAVY-DUTY

\$12,799⁹⁹

FREE SHIPPING!*

POWERFUL HIGH SPEED 3HP 220V MOTOR



- Max. Rim Diameter - 14" - 26"
- Max. Tire Diameter - 63"

WHEEL BALANCERS

DST-2420X Wheel Balancer
SKU OSB RANDST2420X

\$3,299⁹⁹

FREE SHIPPING!*



- Max. Wheel Diameter 10" - 30"
- Max. Tire Diameter - 47"
- Max. Tire Weight - 145 lbs.

DST30PX Wheel Balancer
SKU OSB RANDST30PX

\$3,599⁹⁹

FREE SHIPPING!*



- Max. Wheel Diameter 8" - 30"
- Max. Tire Diameter - 47"
- Max. Tire Weight - 150 lbs.

HOT DEAL

LS45DS Wheel Balancer 3D Quick-Touch™ / Sonar-Spot™
SKU OSB RANLS45DS

\$6,099⁹⁹



- Max. Wheel Diameter 12" - 24"
- Max. Tire Diameter - 43"
- Max. Tire Weight - 145 lbs.

HOT DEAL

FREE SHIPPING!*

RB30T Heavy-Duty Wheel Balancer
SKU OSB RANRB30T

\$14,099⁹⁹

FREE SHIPPING!*



- Max. Tire Weight - 330 lbs.
- Max. Wheel Diameter - 24"
- Max. Tire Diameter 47.25"

HOT DEAL

WHEEL SERVICE

AT26A Tire Changer
SKU OSB APEAT26A

- Internal Clamping - 14" - 26"
- External Clamping - 12" - 24"

AB28 Wheel Balancer
SKU OSB APEAB28

\$2,699⁹⁹

FREE SHIPPING!*

- Max. Wheel Diameter - 12" - 28"
- Max. Tire Diameter 44"

APEX
by BendPak

\$3,599⁹⁹

FREE SHIPPING!*



NEW!

SPRAY WASH CABINETS

RS-500D-601 Professional Spray Wash Cabinet
SKU 82919 RANRS500D

\$9,169⁹⁹

- Load Capacity - 500 lbs.
- Tank Capacity - 50 gal.
- Interior Dimensions - 43" x 32"

RS-750D-601 Truck Spray Wash Cabinet
SKU 82920 RANRS750D

\$9,919⁹⁹

- Load Capacity - 1,000 lbs.
- Tank Capacity - 53 gal.
- Interior Dimensions - 54" x 32"



Ranger

~~\$9,695~~

FREE SHIPPING!*

HOT DEAL

~~\$10,495~~

FREE SHIPPING!*

RS-500DS-601 STAINLESS STEEL Spray Wash Cabinet
SKU 1105323 RANRS500DS

\$14,899⁹⁹

FREE SHIPPING!*

RS-750DS-601 STAINLESS STEEL Truck Spray Wash Cabinet
SKU 1089035 RANRS750DS

\$15,899⁹⁹

FREE SHIPPING!*

EVAPORATIVE AIR COOLERS & CEILING FANS

COOL BOSS™
By BendPak

CB-19L Portable Evaporative Air Cooler
SKU OSB CLBC19L

\$829⁹⁹

HOT DEAL

- Fan Diameter - 19"
- Water Capacity - 15 Gal
- Max. Airflow - 5,300 CFM



CB-26SL Portable Evaporative Air Cooler
SKU 1400045 CLBCB-26SL

\$3,119⁹⁹

HOT DEAL

FREE SHIPPING!*

- Fan Diameter - 26"
- Water Capacity - 50 Gal
- Max. Airflow - 7,540 CFM



CB-28L Portable Evaporative Air Cooler
SKU 1275461 CLBCB-28L

\$3,499⁹⁹

HOT DEAL

- Fan Diameter - 28"
- Water Capacity - 80 Gal
- Max. Airflow - 8,120 CFM



THESE FANS ARE GINORMOUS

CB-11HVLS 11.5 ft. Diameter Industrial Ceiling Fan
SKU OSB CLBCB11HVLS

\$4,199⁹⁹

FREE SHIPPING!*

- 4,200 m³ Per Min. Air Volume

CB-20HVLS 20 ft. Diameter Industrial Ceiling Fan
SKU OSB CLBCB20HVLS

\$6,399⁹⁹

FREE SHIPPING!*

- 12,700 m³ Per Min. Air Volume

*Free shipping to direct shipping points within the 48 contiguous states (excluding surcharges).

Special Pricing Good Through September 30, 2026

TIRE SERVICE

FOR HELP with Selection, Confirm Availability and Ordering Instructions, Call 901-300-4878

TIRE SERVICE

Coats Combos

RC-45E and 1300 Series Tire Service Combo

SKU 477206 **12,449⁹⁹**
AMMCOMB04

SAVE*
\$609

- External Rim Clamping Range from 6" to 24" (Max Tire Diameter 50"; Max Rim Width 10.5")
- RC-45E Drive System: 1 HP Electric Motor
- Tire Changer Allows Inflation from 0 to 60 psi with a Built-In Pressure Limiter
- 1300 Series is Powered by Direct Drive
- Static-On-Screen® Display Identifies Any Excess Residual Static Imbalance
- Wheel Balancer Automatically Enters 2-D Data for Wheel Diameter and Offset Measurement

AMM80013002D



AMM8560994901

INCLUDES:
Setup and Training

AMM80013002D - WARRANTY: 3 Years Parts and 6 Months Labor
AMM8560994901 - WARRANTY: 1 Year Parts and 6 Months Labor

* Savings based on the price of items if purchased separately.

RC-55E and 1300 Series Tire Service Combo

SKU 597289 **14,849⁹⁹**
AMMCOMB02

SAVE*
\$759

- RC-55E Features an External Clamping Range from 6" to 24" (Max. Tire Diameter 50"; Max. Rim Width 10-1/2")
- RC-55E Drive System: 1 HP Electric Motor
- Tire Changer Allows Inflation from 0 to 60 psi with a Built-In Pressure Limiter
- 1300 Series Wheel Balancer is Powered by Direct Drive
- Static-On-Screen® Display Identifies Any Excess Residual Static Imbalance
- Wheel Balancer Automatically Enters 2-D Data for Wheel Diameter and Offset Measurement

AMM80013002D



AMM8560995001

INCLUDES: Setup and Training

AMM80013002D - WARRANTY: 3 Years Parts and 6 Months Labor
AMM8560995001 - WARRANTY: 1 Year Parts and 6 Months Labor

* Savings based on the price of items if purchased separately.

DON'T FORGET THESE ACCESSORIES

- Works with Coats Wheel Balancers Listed on This Page



Adjustable Pin Plate Set 1,599⁹⁹
SKU OSB | AMM8200000400

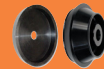

40 mm Light Truck Cone 459⁹⁹
SKU 212844 | AMM8113277C

Customize Your Own Combo, Call for Special Pricing **901-300-4878**

Atlas Combo

Platinum PTC300 and WB50 Tire Service Combo

SKU OSB **9,099⁹⁹**
ATLAPTCWBCB1FPD

NEW

SAVE*
\$459

- PTC200 Tire Changer with Assist Arm Helps Manage Stiff Sidewalls and Low-Profile Tires
- Handles Up to 38" Tire Diameter and 12"-24" Rim Sizes, Covering Most Passenger and Light Truck Fitments
- Internal Rim Clamping Secures Steel and Alloy Wheels without External Jaw Interference
- WB50 Wheel Balancer Features Digital Display and Standard Dynamic/Static Modes
- 110V Operation to Run on Standard Shop Power



ATLAP-PTC300FPD



ATLPWB50110VFPD

WARRANTY: 2 Years Parts

* Savings based on the price of items if purchased separately.

Rotary Combo

R146P and R148 Tire Service Combo

SKU OSB **14,259⁹⁹**
ROTRCOMB05

SAVE*
\$989

- R146RP Tire Changer with Swing-Arm Design, Helper Arm and Hand Bead Breaker; Handles Wheels up to 26" Outside Clamping and Tire Diameters up to 46"
- Built-In Air Tank and Plastic Mount/Demount Head
- R148 Pro 2D Wheel Balancer Features Auto Distance and Diameter Entry, LED Display and Split/Hidden Weight Modes
- Includes: 8 Piece Double Sided Collet Kit
- Rim Diameter: 10" to 30"
- Rim Width: 1.5" to 22"



ROTR148



ROTR146P

INCLUDES: Setup and Training

* Savings based on the price of items if purchased separately.

WARRANTY: 3 Years Parts and 1 Year Labor



Customer Responsible For Offloading, Liftgate Service Available.

For OSB, Call 901-300-4878

- Free Delivery in 48 Continental United States
- Specifications Subject to Change without Notice or Liability
- Equipment Lead Times and Shipping May Vary
- Customers Responsible for Offloading Equipment Upon Arrival
- Leasing Terms Available, Ask Your AutoZone® Commercial Sales Manager.

Prices subject to change without notice. Prices do not include applicable taxes, vehicles, tires, rims, installation or optional equipment as shown. Please do not return purchases to the store. For information regarding warranty, repair, or any questions or concerns, call 901-300-4878.

AZG0326

99

TIRE SERVICE

CEMB Combos

EZ10 and SM825EVOPA Swing Arm Tire Changer Combo

SKU OSB
CMBCOMB03 **10,899⁹⁹**

- Tire Changer Clamping Range of 13" to 24"
- Max. Tire Diameter 44" and Max. Tire Width 15"
- Powerful and Adjustable Bead Breaker Shovel
- Dual Clamping Cylinders and Semi-Automatic Swing Arm
- 3D Wheel Measurement with Sonar
- Automatic Approach and Auto Adaptive Mode to Save Balancing Time
- Electromagnetic Brake
- 3D Inner Data Entry Arm Eliminates Rim Width Caliper Use
- Direct Measures Input Feature Eliminates Selection of Balancing Modes
- Guided Weight Placement, ALU, Hidden Spoke Modes



CMBEZ10

SAVE*
\$899

Includes Press Arm



CMBSM825EVOPA

* Savings based on the price of items if purchased separately.

ER72D Balancer and SM628BPS Tire Changer Combo

SKU OSB
CMBCOMB04 **17,699⁹⁹**

- Includes ER72D Balancer and SM628BPS Tire Changer
- Tire Changer: Clamps Up to 28" Rims, Handles Tires Up to 44" Diameter
- Ideal for 19.5" Tires
- Balancer: Laser Weight Spotter and 3D Data Arm Entry
- Guided Weight Placement and Quick-Clamp Wing Nut



CMBER72D



CMBSM628BPS

CEMB
WHEEL SERVICE EQUIPMENT

SAVE*
\$1,049

* Savings based on the price of items if purchased separately.

On-Site Training Included

WARRANTY: 2 Years Parts and 1 Year Labor

Ranger Combos

R980DP and DST30PX Tire Service Combo

SKU OSB
RANCOMB021 **11,099⁹⁹**

- R980DP Tire Changer Capacity – Handles 9"–30" Internal Clamping and 9"–26" External Clamping with Up to 50" Max. Tire Diameter, Covering Passenger, Light Truck and Oversized Applications
- Dual Assist Tower System (R980DP) – Dual Pneumatic Assist Arms with Bead Roller and Multi-Assist Tool Improve Control on Stiff Sidewalls and Low-Profile Tires, Reducing Operator Strain
- High-Performance Mounting System (R980DP) – Electric Turntable, RimGuard™ Clamping and TurboBlast Bead Seating Deliver Secure Wheel Handling and Faster Bead Seating
- DST30PX Balancer Capacity – Supports Up to 30" Rim Diameter Wheels with a 40 mm Shaft, Accommodating Modern OE and Aftermarket Wheel Sizes
- Precision Balancing Technology (DST30PX) – Digital Measurement System with Multiple Balance Modes Improves Accuracy and Reduces Setup Time for Repeatable Results



RANDST30PX



RANR980DP

* Savings based on the price of items if purchased separately.

R980XR and DST-2420X Tire Service Combo

SKU OSB
RANCOMB01 **7,449⁹⁹**

- Includes: R980XR NEXTGEN™ Swing-Arm 30" Tire Changer and the DST-2420X Dynamic Wheel Balancer
- R980XR External Rim Clamping Capacity: 9" to 28", Internal Clamping 10" to 30"
- 3-Position RimGuard™ Wheel Clamps
- DST-2420X Dynamic Wheel Balancer Dependably Ensures an Accurate Result within Hundredths of an Ounce



RANDST2420X



RANR980XR

* Savings based on the price of items if purchased separately.

R76ATR and LS45DS Tire Service Combo

SKU OSB
RANCOMB014 **13,299⁹⁹**

- Includes: R76ATR Tire Changer and LS45DS Wheel Balancer
- R76ATR Tilt-Tower Tire Changer
- Handles External Rim Clamping from 9" to 28"
- Equipped with a Durable Electric Turntable with Reversible Direction
- LS45DS Sonar 3D Wheel Balancer
- Features Automatic 3D Data Entry for Faster, More Accurate Balancing
- Supports Wheel Sizes from 12" to 24"
- Accommodates Tires Up to 31.5" in Diameter



RANLS45DS



RANR76ATR

* Savings based on the price of items if purchased separately.

User Setup Required

WARRANTY: 1 Year Parts and Labor



Customer Responsible For Offloading, Liftgate Service Available.

For OSB, Call 901-300-4878

- Free Delivery in 48 Continental United States
- Specifications Subject to Change without Notice or Liability
- Equipment Lead Times and Shipping May Vary
- Customers Responsible for Offloading Equipment Upon Arrival
- Leasing Terms Available, Ask Your AutoZone® Commercial Sales Manager.

TIRE SERVICE

FOR HELP with Selection, Confirm Availability and Ordering Instructions, Call 901-300-4878

TIRE SERVICE

Coats Tire Changers

Maxx 50 Tire Changer, 110V

SKU 1350784
AMM800MAXX50E **7,549⁹⁹**

- Dual Nozzle, Hi-Flow Bead Sealing System for Quick, Easy Bead Sealing
- 110V Electric Operation, Plug In Almost Anywhere
- 6" to 24" Steel Clamps Standard
- Nylon Duckhead Standard
- Expanded Capacity to 16" Wheel Width, and Up to 50" Total Diameter



AMM800MAXX50E

Maxx 50 Tire Changer, Air

SKU OSB
AMM800MAXX50A **7,549⁹⁹**

Maxx 70 Tire Changer, 110V

SKU OSB
AMM800MAXX70 **9,889⁹⁹**

- Dual Nozzle, Hi-Flow Bead Sealing System for Quick, Easy Bead Sealing
- 110V Electric Operation, Plug in Almost Anywhere
- Expanded Capacity to 16" Wheel Width and Up to 50" Total Diameter
- 6" to 24" Steel Clamps Standard
- Steel and Nylon Duckheads Standard
- No-Index Tabletop for High Efficiency Use



AMM800MAXX70

Maxx 70 Tire Changer, Air

SKU OSB
AMM800MAXX70A **9,889⁹⁹**

Maxx 70 Tire Changer, 220V, 2 HP

SKU OSB
AMM800MAXX70220 **9,889⁹⁹**

Maxx 80 Tire Changer, 110V

SKU 1354781
AMM800MAXX80 **11,249⁹⁹**

- Dual Nozzle, Hi-Flow Bead Sealing System for Quick, Easy Bead Sealing
- Dual Control, Hand or Foot Operated Bead Loosener System
- 110V Electric Operation, Plug in Almost Anywhere
- 6" to 24" Steel Clamps and Zinc Plated 6" to 24" Grip Max. 2.0 Clamps with Dual Soft Compound Inserts
- Expanded Capacity to 16" Wheel Width and Up to 50" Total Diameter
- Steel and Nylon Duckheads Standard
- No-Index Tabletop for High Efficiency Use
- Includes Storage Cabinet



AMM800MAXX80

Maxx 80 Tire Changer, Air

SKU 1354782
AMM800MAXX80A **11,249⁹⁹**

Tire Changer, 220V, 2 Speed

SKU OSB
AMM800MX802SP **11,799⁹⁹**

Maxx 80 Tire Changer, 220V, 2 HP

SKU 1350785
AMM800MX80220 **11,249⁹⁹**

INCLUDES: Setup and Training

WARRANTY: 3 Years Parts and 6 Months Labor

Coats Wheel Balancers

RC450 Wheel Balancer

SKU OSB
AMM800RC450 **4,999⁹⁹**

- Fits in Small Location with Standard 110V Power
- Indirect Motor 110V
- Entry-Level Low Price Point
- 110V



WARRANTY:
1 Year Parts
6 Months Labor

RC550 Wheel Balancer

SKU OSB
AMM800RC550 **6,229⁹⁹**

- Fits in Small Location with Standard 110V Power
- Indirect Motor 110V
- Laser Pin Point Accuracy
- 110V



WARRANTY:
1 Year Parts
6 Months Labor

1600A 3D Wheel Balancer

SKU 82860
AMM80016003D **11,329⁹⁹**

- Powered by Direct Drive
- Max. Tire Diameter: 44"
- Premium Quicknut
- Behind-the-Spoke Balancing
- 8 Piece Collet Kit
- Automatic 3-D Data Entry
- Touch-Screen
- 220V, 1 Phase



WARRANTY:
3 Years Parts and
6 Months Labor

INCLUDES: Setup and Training



Customer Responsible For Offloading, Liftgate Service Available.

For OSB, Call 901-300-4878

- Free Delivery in 48 Continental United States
- Specifications Subject to Change without Notice or Liability
- Equipment Lead Times and Shipping May Vary
- Customers Responsible for Offloading Equipment Upon Arrival
- Leasing Terms Available, Ask Your AutoZone® Commercial Sales Manager.

Prices subject to change without notice. Prices do not include applicable taxes, vehicles, tires, rims, installation or optional equipment as shown. Please do not return purchases to the store. For information regarding warranty, repair, or any questions or concerns, call 901-300-4878.

AZG0326

101

TIRE SERVICE

FOR HELP with Selection, Confirm Availability and Ordering Instructions, Call 901-300-4878

CEMB

Automatic Wheel Balancer with Monitor

SKU OSB
CMBER65
6,599⁹⁹

- Auto-Data Entry of Distance, Diameter and Width
- Laser Pointer for Weight Placement
- 17" Monitor with Intuitive Software
- Auto-Approach Positions Wheel at Correction Point



On-Site Training Included

WARRANTY: 2 Years Parts and 1 Year Labor



3D Data Entry Wheel Balancer

SKU OSB
CMBEZ15 **5,099⁹⁹**

- Electro-Magnetic Brake Holds Weight Position
- Quick-Clamp Wing Nut Auto Adaptive Enhancement with Static Residual Force Minimization
- 3D Inner Data Entry Arm Eliminates Rim Width Caliper Use
- Guided Weight Placement, ALU, Hidden Spoke Mode



On-Site Training Included

WARRANTY: 5 Years Motor, 2 Years Parts, and 1 Year Labor

Hofmann

monty® 3550EM Tire Changer with smartSpeed™

SKU 751702
HOFEEWH747B **12,999⁹⁹**

- smartSpeed™ Technology Automatically Controls Turntable Speed and Torque to Minimize Tire and Wheel Damage
- Push-Button Controlled Mount/Demount Head Pneumatically Lowers and Locks into Position, Automatically Indexing Away from the Wheel to Prevent Contact and Damage
- Fast and Ergonomic Pneumatic Vertical Arm Automatically Re-Positions the Mounting Head to Minimize Wheel Damage
- High Capacity Tire Changer Allows for Broadest Tire and Wheel Assembly Coverage
- Clamping Range: Inside 12" to 28"; Outside 12" to 26"
- Max. Tire Diameter: 47"
- Max. Tire Width: 17"



INCLUDES:
Setup and Training

WARRANTY: 1 Year Parts and 6 Months Labor



geodyna® 7600P with Laser and Power Clamp

SKU OSB
HOFEEWB765AP **9,999⁹⁹**

- Power Clamp Clamps Wheel Accurately with Constant Force
- Smart Sonar™ Delivers Automatic, Non-Contact Rim Width
- Acquisition Split Weight Mode, Allows Exact Placement of Weights Behind Spokes



INCLUDES:
Setup and Training

WARRANTY: 1 Year Parts and 6 Months Labor

Ranger

DST2420X Wheel Balancer

SKU OSB
RANDST2420X **3,299⁹⁹**

- 43" Capacity Redesigned Hood Accommodates a Wide Variety of Tire Assemblies
- Precision Digital Sensor Technology Multi-Directional Quartz Piezoelectric Sensors Deliver Highly Accurate, Repeatable Balancing Results to ±1 Gram
- ~6-9 Second Cycle Times with Automatic Braking and LED Weight Guidance



R980XR NextGen™ Swing-Arm Tire Changer

SKU 312817
RANR980XR **4,799⁹⁹**

- Motor: 3 HP/220V
- Drive System Type: Electric/Air
- Adjustable RimGuard™ Wheel Clamps
- External Rim Clamping Capacity: 9" to 28"
- Internal Rim Clamping Capacity: 10" to 30"
- Max. Tire Diameter: 50" (1,270 mm)
- Bead Seating System: Turbo Blast/Bead Seating



User Set-Up Required

WARRANTY: 1 Year Parts and Labor

R80EX Tire Changer

SKU OSB
RANR80EX **11,099⁹⁹**

- Ranger's Adjustable RimGuard™ Wheel Clamps Feature Internal and External Multi-Teeth Jaws
- Variable Clamp Positioning Makes Wheel Service Simple, Perfectly Controlling the Wheels When Clamping Them
- Geometric Tabletop Provides Easier Bead Lubrication Features a Multi-Axis and Adjustable Bead Loosener Shovel Blade Oversized Axle Minimizes Blade Flex and Improves Durability
- Motor: 3 HP (220 VAC 50-60 HZ)



40 mm Truck Cone Kit SKU OSB | RAN5150032 **464⁹⁹**

Works with Ranger Wheel Balancers Listed on This Page



Customer Responsible For Offloading, Liftgate Service Available.

For OSB, Call 901-300-4878

- Free Delivery in 48 Continental United States
- Specifications Subject to Change without Notice or Liability
- Equipment Lead Times and Shipping May Vary
- Customers Responsible for Offloading Equipment Upon Arrival
- Leasing Terms Available, Ask Your AutoZone® Commercial Sales Manager.

TPMS Tools

INDUSTRY-LEADING COMPATIBILITY with OE and Aftermarket TPMS Sensors



TS37 TPMS Reset, Trigger and Relearn Tool with 4 Sensors

SKU OSB
OEMTS374K **279⁹⁹**

- Fast, Simple TPMS Relearns for Most Domestic and Import Vehicles



VT47 Wi-Fi TPMS Reset and OBDII Programming Tool with 10 Sensors

SKU OSB
OEMVT4710K **599⁹⁹**

- Scan, Diagnose and Relearn TPMS with Built-In OBDII Support



VT57 All-In-One TPMS and OBDII Tire Management Tool with 20 Sensors

SKU OSB
OEMVT5720K **1,199⁹⁹**

- Advanced TPMS + Tire Tread Diagnostics with Full Sensor Coverage



EACH Sensor Comes with a Rubber Valve and a Metal Stem

VT47 TPMS Tool with 4 TPMS Sensors

SKU OSB
OEMVT474K **549⁹⁹**



VT57 TPMS Tool with 100 TPMS Sensors

SKU OSB
OEMVT57100K **2,199⁹⁹**



For OSB, Call 901-300-4878

FUNCTIONALITY

	TS37	VT47	VT57
VIN Barcode Scanner to Select Make, Model and Year			✓
Wi-Fi and Real-Time Updates Powered by Live Sensor™		✓	✓
Programs Aftermarket Sensors (Including EZ-Sensor® and All Leading Brands)	✓	✓	✓
Provides Direct (OBD, Auto, Manual) and Indirect TPMS Relearn Procedures	✓	✓	✓
98.6% TPMS Reset Coverage, Including Bonus ECU Reset Coverage in <2 Min. (OBD Connectivity)		✓	✓
ECU Unlock for Toyota, Scion and Lexus Models (Closed Loop)		✓	✓
OE and Aftermarket TPMS Sensors and Service Kits Part Number Look-Up	✓	✓	✓
Retrieves, Decodes and Clears TPMS DTCs		✓	✓
Tire Management, DOT, Tread Reading and More		✓	✓
Software Updates	3 Years	3 Years	5 Years

AutoZone® Tool & Equipment QUARTERLY

Call Us at 901-300-4878

Get expert guidance, top brands, and full after-sale support. Our team is manufacturer-trained to help you select the right tools, check availability, and provide competitive pricing. Visit our website for even more products, www.AZtool1.com

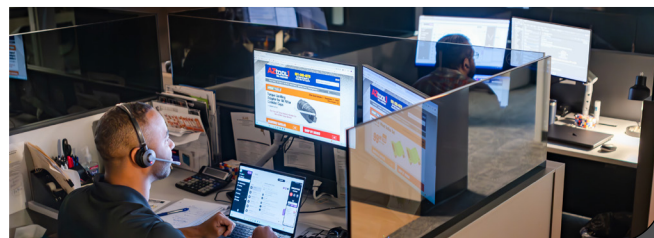

TIRE SERVICE

CALL FOR PRICE

AUTEL MAXITPMS

CALL FOR PRICE

MaxiTPMS® TS508 WiFi Kits SKU #1328117 | Part #700180

- Update software directly from tool-enabled Wi-Fi
- Quick Mode & Advanced Mode Options
- Read/Activate/Relearn All Known Sensors
- Detect & Display TPMS System Faults
- Display Vehicle-Specific Relearn Procedures; Perform OBDII Relearns
- Placard Value Reset on Supported Vehicles
- 4 Programming Methods: MX-Sensors Only
- FREE Software for lifetime of tool
- 4 1-Sensors & Metal Valve Included



SKU #1413611
Part #700190

SKU #1538300
Part #700330



MaxiTPMS® ITS600PRO1 SKU #1140847 | Part #ITS600PRO1

- Complete TPMS Service and Diagnostics Tablet
- 5.5 Inch Color Touchscreen/Android 9.0 OS
- Activates, Reads and Relearns All Known Sensors
- On-Tool DOT Tire Registration
- 4 MX-Sensor Programming Methods



Part #700190 SHOWN

MaxiTPMS® MX-Sensor BLE SKU #1366285 | Part #300100

- Pre-programmed Bluetooth Low Energy TPMS sensors for Tesla 3/Y/S/X models
- Tesla-ready: Just Fit and Go
- Future-proof: programmable with Autel TPMS tools for the latest BLE-equipped vehicles

MaxiTPMS® 1-Sensor | SKU #31745 | Part #1SENSOR

- Combined Frequency: 315MHz & 433MHz
- Interchangeable Valve Stems (rubber included)
- Program to Replace 99% of OE Sensors
- Fast valve stem swap

MAXITPMS® 1-SENSORM SKU #1064478 | Part #1SENSORM

- Same as 1-Sensor with Aluminum stem



MaxiTPMS® 1-Sensor 20-Pack (R) SKU #370328 | Part #300010

- Bulk pack of 20 1-Sensors with Rubber Valves



MaxiTPMS® 1-Sensor 20-Pack (M) SKU #1107286 | Part #300060

- Bulk pack of 20 1-Sensors with Aluminum Valves

MaxiTPMS® 1-Sensor 240 Pack SKU #1089240 | Part #300050

- Bulk pack of 240 1-Sensors with Rubber Valves

MaxiTPMS® 1-Sensor 100 Pack SKU #1128315 | Part #300070

- Bulk pack of 100 1-Sensors with Rubber Valves



MaxiTPMS® TS900 SKU 1337325 | Part #TS900

- Activate, Read, and Relearn ALL known TPMS sensors, including Tesla OE sensors
- Program universal Autel 1-Sensors to replace 99% TPMS sensors
- 4 MX-Sensor Programming Methods
- Compatible with BLE TPMS sensors and Autel BLE Sensor for Tesla vehicles
- Features Android 11 operating system and 64GB storage memory
- All Systems Diagnostics with bi-directional controls, Active Tests & Special Functions

MaxiSYS® MS906 PRO2-TS SKU #1607400 | Part #MS906PRO2TS

- All systems diagnostics • 1-Sensor programming
- TPMS sensor activation/read/relearn
- Embedded TPMS antenna for broad support including for Tesla vehicles
- Secure gateway module access on newer vehicles
- 4 MX-Sensor Programming Methods



MaxiTPMS® ITS600 CV SKU #1573165 | Part #700420

- Complete TPMS Service tool for Commercial Vehicles
- Industry-leading coverage for TPMS-enabled Trucks, Trailers, Buses
- Program Autel MX-Sensor CVS-A01433 MHz Sensor to replace OE and programmed aftermarket sensors
- Separate Tractor & Trailer interfaces display up to 46 wheels & 12 axes
- Includes Deutsch 6 and 9-pin, and UNIU-4 DLC adapters
- 4 MX-Sensor Programming Methods

MX-Sensor CVS-A01 TPMS Sensor for Commercial Vehicles SKU #1573139 | Part #300170

- Includes metal band to attach sensor to rim, compatible with rims sized 14 to 24.5-inches

SKU #1573138 | Part #300190

- Includes fabric band to attach sensor to rim, compatible with rims sized 14-17.5-inches

SKU #1573141 | Part #300210

- Includes fabric band to attach sensor to rim, compatible with rims sized 17.5 to 24.5-inches

NEW HEAVY DUTY TPMS SERVICE



AUTEL
THE SMARTER CHOICE
FIND OUT WHY



AUTEL

Inflators

OEM TOOLS

Digital Tire Inflator

SKU 802198
24412 **119⁹⁹**

- Easy-to-Read Backlit LCD Display
- 4 Units of Measure (psi, Bar, KPa, kgf)
- Measuring Range: 0 to 175 psi (0 - 12 Bar)
- Accuracy: +/-1.2 psi Up to 58 psi, +/-2.3 Between 58 psi and 145 psi Inclusive, +/-3.6 psi Greater Than 145 psi
- High Air Flow Saves the Technician Time



Dial Tire Inflator

OEM TOOLS

SKU 301772
24380 **97⁹⁹**

- Clear and Easy-to-Read 80 mm 180 psi Gauge
- 3-In-1 Function: Inflate, Deflate and Measure Tire Pressure
- Increased Accuracy to Improve Tire Performance and Prevent TPMS Comebacks



Wheel Stud Tools

Wheel Stud Installer

SKU 339123
24234 **14⁹⁹**

- Works with Hubs, Rotors and Axles on Both Front and Rear Wheel Drive Vehicles
- Prevents Damage to Lug Nut or New Stud
- Designed to Fit Studs Up to 14 mm or 9/16"



8 Piece Wheel Stud Alignment Guide Kit

SKU 818715
24233 **34⁹⁹**

- Makes the Job Faster and Easier Allowing the Tech to Safely Position the Wheel Prior to Installing the Wheel Bolts
- Applications: Mercedes-Benz, BMW, Audi, VW, Porsche, Fiat and Dodge
- Sizes Included:
12 mm x 1.5
12 mm x 1.25
14 mm x 1.25
14 mm x 1.75



Truck Wheel Stud Installer

OEM TOOLS

SKU 339117
24235 **14⁹⁹**

- Designed to Work on Truck Wheel Studs Up to 22 mm (7/8") in Diameter
- Use with an Impact Wrench or Ratchet

Wheel Stud Installer Set for Cars and Trucks

SKU 1544687
24239

- Set Includes 24234 and 24235



24⁹⁹
REG. \$29.98

SAVE \$4 OVER
When You Buy the Set

3.5" Digital Tire Inflator with Hose

SKU 1268419
AST3018 **114⁹⁹**

- 21" Stainless Braided Hose
- Dual AAA Battery Powered Design
- Backlit LCD Digital Read-Out
- Includes Batteries



Astro

Bead Seater

5 Gallon Bead Seater

SKU 526505
24449 **139⁹⁹**

- Seats Beads on All Tires, from Small 4" Tires to 24-1/2" Truck Tires
- Operates on Standard Shop Air; Max. 120 psi



OEM TOOLS

TIRE SERVICE

TO ORDER, contact your Commercial Sales Manager or go to AutoZonePro.com

TIRE SERVICE

Mount/Demount Heads	Fits	Models	OE Part Number		Fits	Models	OE Part Number
Red Nylon Mount/Demount Head SKU 1137811 49⁹⁹ SHA35034 	Hunter	TC250, TC300, TC325, TC350, TC2000, TC3250, TC3500, TC3000 and TC3100 Series	221-615-2-13	Nylon Mount/Demount Head without Hardware SKU 1125892 44⁹⁹ SHA35033 	Accuturn	3602, 3602HP, 4260, 4560MR, 4602, 5602 and 5602 HP	2002433, 14024784
	Accuturn	(Requires Adapter) 220A, All Other Models Require 102765 Adapter	SM102529		Hofmann	1520, 1565, 1620, 1625EM, 3300, 3300EM, 1270, 2300, 3000 and 3000GP	4024784, ST0024335
	Ranger	R980X Rev A Models, R980XR/NXT, R30XLT, RX-850/950-B Models, R23/23ST, R26ST/26EX, R745 and R710 Models ONLY. Require RAN5150524 Adapter	5150523		John Bean	EHP System IVE, IV, III, IIE	2433, EAA 0247G20A
Nylon Mount/Demount Tapered Hole Head with Hardware SKU 1137818 40⁹⁹ SHA38306 	Coats	5030, 5040, 5045, 5050, 5060, 5065, 6050, 6060, 6065, 7050, 7055, 7060, 7065, 7660, 7665, 50X, 60X, 70X, 80X, GTS, RC45, RC55, Maxx50, 70 and 80	8183061	Nylon Mount/Demount Head with Round Hole Kit SKU 1137815 99⁹⁹ SHA35030 	Snap On	All Models	2433, EAA 0247G20A
	Baseline	BL200, BL300, BL400 and BL500	8183061		All Tool	All Models	2008402
Low Profile Mount/Demount Head SKU 1125869 64⁹⁹ SHA35038 	Coats	Replacement for Coats 8184432. For use on Models RC100, RC150, RC200, 5030, 5035, 5040, 5045, 5050 Series, 5060 Series, 5065 Series, 6050, 6060, 6065, 7050, 7055, 7060, 7065, 7655, 7660, 7665, BL200, BL300, BL400 and BL500	8184432	Nylon Mount/Demount Head SKU 1125877 39⁹⁹ SHA35031 	Coats	Early 5060, Early 5060A, Early 5060E, Early 5060AX, Early 5060EX, 9010A, APX80A, APX80E, APX90, APX90A, APX90E, RC-1, RC1, RC-5A, RC5A, RC-15A, RC15A, RC-20AA, RC20AA	83008402, 83008403
					CEMB	All Models	3008403, 2008402
Nylon Mount/Demount Head with Hardware SKU 459195 42⁹⁹ TMRTC14024784 	Accuturn	3602, 3602HP, 4260, 4560MR, 4602, 5602 and 5602 HP	2002433	Nylon Mount/Demount Head SKU 1125877 39⁹⁹ SHA35031 	Hofmann	12SE, 22SE, 1510, 1610, S410 Not for use on Hofmann: 1550, 1620 and 1625	8314813
	Hofmann	1520, 1565, 1620, 1625EM, 3300, 3300EM, 1270, 2300, 3000 and 3000GP	4024784		Hunter	Fits Many Hunter TCX series	RP11-8-11400327, RP11-8314813, 83008403
	John Bean	EHP System IVE, IV, III, IIE	24335		Giuliano, Corgi, SICE	Fits Giuliano, Corgi, and SICE Machines	Giuliano – 8314813 Corgi – 4-120129B SICE – 3008403
	Snap On	All Models	24335				

Rim Protectors

10 Pk. Quilted Clamp Sock for Rim Clamp Jaw

SKU OSB **39⁹⁹**
 TMRTC183604

- Replacement for Coats 8183604
- For Use with All Rim Clamp RC and TC Jaws Except 9010 and 9024E and Models with Grip Max Clamps



For OSB, Call 901-300-4878



Hybrid Duckhead Tail - 2 Pack

SKU 1442586 **44⁹⁹**
 AMM8560896102



- Designed to Float Across the Rim, Decreasing the Stretching of the Bead
- Compatible with Hybrid Duckhead® Mount/Demount Tool (85608959)
- Compatible with All X-Series and RC Series That Have Hybrid Duckhead® Mount/Demount Tools



Prices subject to change without notice. Prices do not include applicable taxes, vehicles, tires, rims, installation or optional equipment as shown. Please do not return purchases to the store. For information regarding warranty, repair, or any questions or concerns, call 901-300-4878.

TIRE SERVICE

Non-Marring Lug Nut Sockets

OEM TOOLS®

1/2" Drive 17 mm Mercedes-Benz® Flower Lug Bolt Impact Socket

SKU 081308 **19⁹⁹**
24469

- Designed Specifically for 17 mm, Convex "Flower" Shaped Mercedes Lug Bolts



9 Piece Thin-Wall Wheel Protector Impact Socket Set

SKU 965856 **99⁹⁹**
24224

- Sizes: 3/4", 7/8", 13/16", 15/16", 1", 1-1/16", 17 mm, 19 mm and 21 mm



3 Piece Thin Wall Nut Protector Impact Socket Set

SKU 94646 **29⁹⁹**
25583

- Includes: 17 mm (11/16") Blue, 19 mm (3/4") Yellow, and 21 mm (13/16") Red
- Made of Chrome Moly Steel for Strength
- Designed to Protect High Polished Wheels and Lug Nuts from Damage
- Color Coded for Easy Identification

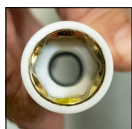

3 Piece Super Strength Wheel Nut Impact Socket Set

SKU 347212 **43⁹⁹**
24227

- Blue - 17 mm/11/16"
- Gold - 19 mm/3/4"
- Red - 21 mm/13/16"



Lug Nut Sockets

OEM TOOLS®

Master Lug Nut Kit

SKU 1190208
68919

- Includes: 2 Socket Sets for Removing, Locking, Damaged and Undamaged Lug Nuts on Most Vehicles
- Ideal for Removal of Warped and Mangled Chrome-Cap Style Lug Nuts
- Easily Removes Locking Lug Nuts on Most Aftermarket Wheels



109⁹⁹

REG. \$123.98

SAVE OVER \$13

When You Buy the Kit

16 Piece Locking Lug Master Key Set

SKU 626107 **89⁹⁹**
24447

- Easily Removes Locking Lug Nuts on Most Aftermarket Wheels
- Thin-Wall Sockets Prevent Damaging Wheels and Lugs
- Hex-Head Design Fits Most Lug Wrenches as well as 13/16" and 7/8" Sockets



4 Piece Deep Thin-Wall SAE and Metric Impact Flip Socket Set

SKU 965857 **44⁹⁹**
24223

- Includes: 3/4" to 13/16", 19 mm to 21 mm and 7/8" to 15/16" Sockets and 3" Extension



5 Piece 1/2" Drive Flip Socket Set

SKU 1125891 **33⁹⁹**
25555

Half Metric Sizes for Removal of Warped and Mangled Chrome-Cap Style Lug Nuts

- Durable CR-MO Flip Socket Set
- Includes: 18.5 mm x 19.5 mm, 19 mm x 21 mm, 21 mm x 21.5 mm, 22 mm x 22.5 mm and 1/2" Drive Extension



Torque Limiting Sets

OEM TOOLS®

8 Piece Torque Limiting Extension and Thin Wall Socket Set

SKU 347217 **99⁹⁹**
24228

- 4 Extension Bars: 65Ft/Lb. (90 Nm), 90 Ft/Lb. (120 Nm), 100 Ft/Lb. (135 Nm) and 110Ft/Lb. (150 Nm)
- 4 Deep Sockets: 17 mm, 19 mm, 21 mm, 22 mm



5 Piece 1/2" Drive Torque Limiting Extension Set

SKU 965858 **89⁹⁹**
24220

- Quick, Simple and Accurate
- Helps Prevent Lug Stud/Nut Damage and Warped Rotors
- Includes 1/2" Drive Extensions: 65 Ft/Lb., 80 Ft/Lb., 100 Ft/Lb., 120 Ft/Lb. and 140 Ft/Lb.
- Made with Flexible Chromoly Steel that Stops Turning When the Required Torque is Reached
- Comes in a Sturdy Blow Mold Case



Torque Wrenches

OEM TOOLS®

3/8" Drive (10-80 Ft/Lb.)

SKU 177722 **64⁹⁹**
25694

1/2" Drive (10-150 Ft/Lb.)

SKU 012651 **79⁹⁹**
25689

1/2" Drive (25-250 Ft/Lb.)

SKU 177715 **79⁹⁹**
25695



25695

1/2" Drive Undercar Torque Wrench

SKU 954182 **329⁹⁹**
CEN97354A

- Unique One-Way Design Cannot Be Used as a Breaker Bar (thus Preventing Damage)
- High Contrast Laser Markings for Easier Reading
- Rubber Over-Mold Lock Ring for Better Grip
- Head and Handle Covers for Increased Durability
- Range: 25 to 250 Ft/Lb. (43.4 to 348.4 Nm)
- Length: 23.3"



Central TOOLS, Inc.
QUALITY AND INNOVATION SINCE 1988

TIRE SERVICE

TO ORDER, contact your Commercial Sales Manager or go to AutoZonePro.com

TIRE SERVICE

Tire Service Tools

OEM TOOLS®

2 Piece Tire Valve Core Tool Set

SKU 1209377 **9⁹⁹**
22589

- Designed for Removal and Installation of Schrader Style Valve Cores
- Includes: 2" and 5" Tools
- Extra-Long 5" Tool for Hard-to-Reach Applications
- Tough Impact and Solvent-Resistant Acetate Handle



Tire Tube Test Tank

SKU 291382 **109⁹⁹**
LIS19822

- Tank Features Reinforcement Ribs for Extra Support
- Will Handle Passenger Tire Sizes to Wide Oval and Light Duty Truck Tires
- Dimensions: 31" (L) x 12" W x 12" H



Lisle

5025 Tire Spreader

SKU 757051 **449⁹⁹**
BRA00-0161

- Self-Locking Spread Arms
- 4 Horizontal and 2 Vertical Adjustments
- Handles Any Passenger Tire, Including Low Profiles
- Quick Pin Adjustment with Lanyard



Branick

Tire Patch Stitcher 2 Pk.

SKU 1053946 **21⁹⁹**
XTS14-314PK

- Professional Quality Tire Repair Tool
- Stitches Down Patch to Remove Air Bubbles



Xtra seal

Tire Repair

Puncture Repair Set

SKU OSB **179⁹⁹**
XTS14-662

- Includes Puncture Repair Procedures Guide and 20" x 32" Shop Poster
- Enough Supplies to Provide More Than 70 Complete Repairs



Xtra seal

For OSB, Call 901-300-4878

Tire Repair Cabinet Assortment

SKU OSB **649⁹⁹**
XTS14-603

- Deluxe Wall-Mount Cabinet
- Loaded to Complete Over 110 Industry Standard Puncture Repairs
- All the Tools Plus XLIGHT Air Powered Vacuum Carbide Cutters and More



Xtra seal

For OSB, Call 901-300-4878

11" Cotton Tire Swab (6 Pack)

SKU 666324 **21⁹⁹**
XTS14-378PK

- Professional Quality Tire Repair Tool
- Use to Spread Mount/Demount Lube on Bead of Tire



Xtra seal

Mounting/Demounting Compound (2 Pack)

SKU OSB **49⁹⁹**
XTS14-708EPK

- Very Slippery
- No Mixing or Water Required
- Dries Tacky
- Rust Inhibitors Prevent Damage to Tire Bead
- Works Great with Low Pro, Run Flat and Alloy Wheel Applications



Xtra seal

For OSB, Call 901-300-4878

Xtra Slick Tire Bead Lube (2 Pack)

SKU 1281603 **23⁹⁹**
XTS14-753PMPK

- Ready-to-Use Mounting and Demounting Compounds to Prevent Damage to Tire Bead
- Pre-Mixed



Xtra seal

8 Oz. Vulcanizing Cement (3 Pack)

SKU 666342 **24⁹⁹**
XTS14-008PK

- Fast Drying
- Can Be Used with Heat Vulcanization



Xtra seal

57 Piece Tire Repair Kit

SKU 213119 **43⁹⁹**
26686

- Includes: T-Handle Plug Insert Tool, T-Handle Reaming Tool, Replacement Insert Needle, Long Nose Pliers, Hex Keys, 30 Repair Plugs, Utility Knife, Lubricant, Valve Cores, Valve Caps, Valve Stems and a Valve Core Tool



OEM TOOLS®

Refill Plugs for Any OEMTOOLS® Tire Repair Kit

OEM TOOLS®

Repair Plug Refill Sets

- For Use with 26680, 26682, 26683 and 26686



30 Pack
SKU 477063
26684 **9⁹⁹**

100 Pack
SKU 477176
26685 **19⁹⁹**

Prices subject to change without notice. Prices do not include applicable taxes, vehicles, tires, rims, installation or optional equipment as shown. Please do not return purchases to the store. For information regarding warranty, repair, or any questions or concerns, call 901-300-4878.

AZG0326

107

TIRE SERVICE

Wheel Weight Kits

- Steel Weights are More Environmentally Friendly Compared to the Lead Weight Alternative
- Premium Powder Coated Finish Resists Chips and Scratches Which Helps Prevent Damage and Corrosion to Wheels

Complete Wheel Weight Kit with Floor Rack

SKU 1392466
68953A

- Includes 78 Boxes of Coated Clip-On Wheel Weights
- ALFE, LHFE, MCFE, PFE, TFE, ENFE, FNFE and IWFE
- 25 Weights per Box
- All Metal Floor Rack

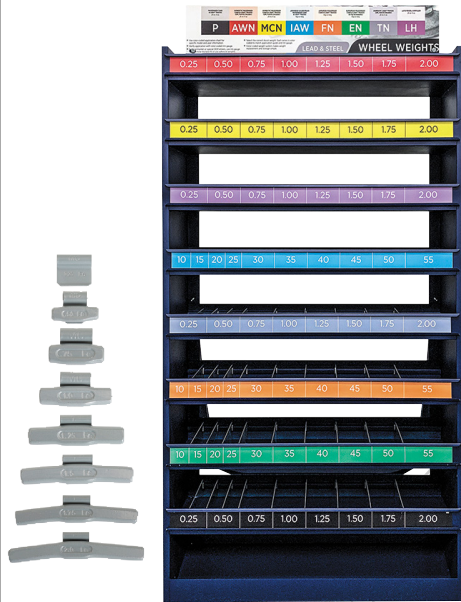

- ALFE Steel**
- LHFE Steel**
- MCFE Steel**
- PFE Steel**
- TFE Steel**
- ENFE Steel**
- FNFE Steel**
- IWFE Steel**

999⁹⁹

REG. \$1,609.21

SAVE OVER \$609
When You Buy the Kit

Wheel Weight Starter Kit with Floor Rack

SKU 1339729
OEMREPLENKITA

- Includes: 18 Boxes of Coated Clip-On Wheel Weights
- ALFE, MCFE and PFE in the Most Popular Sizes
- 25 Weights per Box
- All Metal Floor Rack

- ALFE Steel**
- MCFE Steel**
- PFE Steel**

549⁹⁹

REG. \$631.81

SAVE OVER \$81
When You Buy the Kit

OEM TOOLS®

Adhesive Wheel Weight Starter Kit with Stand

SKU 1392467
68955A

- Includes: 4 Boxes and 2 Rolls of Adhesive Wheel Weights
- 3 Boxes of Strips, .25 Oz, .50 Oz. and 1.00 Oz.
- 1 Box of .25 Oz. Strips, Black
- (2) 10 Lb. Rolls of .25 Oz. and .50 Oz.
- Wheel Weight Dispenser Stand



349⁹⁹

REG. \$511.93

SAVE OVER \$161
When You Buy the Kit

Wheel Weights Only

OEM TOOLS®

Complete Wheel Weight Kit, Weights Only

SKU 1392468
68954A

- Includes 78 Boxes of Coated Clip-On Wheel Weights
- ALFE, LHFE, MCFE, PFE, TFE, ENFE, FNFE and IWFE in the Most Popular Sizes
- 25 Weights per Box



- ALFE Steel**
- LHFE Steel**
- MCFE Steel**
- PFE Steel**
- ENFE Steel**
- FNFE Steel**
- IWFE Steel**
- TFE Steel**

599⁹⁹

REG. \$1,209.22

SAVE OVER \$609
When You Buy the Kit

Wheel Weight Starter Kit, Weights Only

SKU 1392326
68957

- Includes: 18 Boxes of Coated Clip-On Wheel Weights
- ALFE, MCFE and PFE in the Most Popular Sizes
- 25 Weights per Box



- ALFE Steel**
- MCFE Steel**
- PFE Steel**

149⁹⁹

REG. \$231.82

SAVE OVER \$81
When You Buy the Kit

Adhesive Wheel Weight Starter Kit

SKU 1525567
68956

- Includes: 4 Boxes and 2 Rolls of Adhesive Wheel Weights
- 3 Boxes of Strips, .25 Oz, .50 Oz. and 1.00 Oz.
- 1 Box of .25 Oz. Strips, Black
- (2) 10 Lb. Rolls of .25 Oz. and .50 Oz.



199⁹⁹

REG. \$361.94

SAVE OVER \$161
When You Buy the Kit



CALL YOUR COMMERCIAL SALES MANAGER TO ORDER YOUR WHEEL WEIGHTS TODAY

Wheel Weight Tools

Adhesive Wheel Weight Removal/Cutting Tool

SKU 1362016
25096 **27⁹⁹**

- All-In-One Wheel Weight Tool for Removal Installation and Cutting with Precision
- Hammer End with Non-Marring Head Prevents Damage
- Sharp Cutting Edge to Trim Adhesive Wheel Weights
- Jaws Feature a Protected Surface for Non-Marring Removal of Adhesive Wheel Weights
- Anti-Slip Rubber Coated Handle



Clip-On Wheel Weight Hammer Tool

SKU 217378
25690 **26⁹⁹**

- Installs, Removes, Trims and Tightens All Types of Clip-On Wheel Weights
- Features a Special Plastic Material on Hammer Head for Safe, Mar-Free Installation
- Coated Handles for Comfort Grip

OEM TOOLS®



4 Piece Plastic Scraper Set

SKU 900802
25513 **10⁹⁹**

- Will Not Scratch Paint
- Great for Wheel Weight Removal

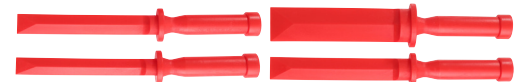

TIRE SERVICE

TO ORDER, contact your Commercial Sales Manager or go to AutoZonePro.com

TIRE SERVICE

Adhesive Weights



SKU	Part#	Size	Type	Description	Price
19304	23200*	.25 Oz.	40 Strips	12 Pieces per Strip, 480 Pieces per Box	52.99
19312	23201*	.25 Oz.	10 Lb. Roll	640 Pieces per Box	63.99
19294	23203*	.50 Oz.	24 Strips	10 Pieces per Strip, 240 Pieces per Box	63.99
19310	23202*	.50 Oz.	10 Lb. Roll	320 Pieces per Box	74.99
1339726	23214	1.00 Oz.	16 Strips	7 Pieces per Strip, 112 Pieces per Box	67.99
1339728	23216	.25 Oz.	30 Strips	Black, 8 Pieces per Strip, 240 Pieces per Box	37.99



STORE STOCKED*

Wheel Weight Racks



Adhesive Wheel Weight Dispenser Stand

SKU 1363723
23209 **149.99**

- Easy Assembly
- Can Be Secured to Workshop Floors
- Holds 2 Rolls
- All Metal Construction



Mounting Hardware and Wheel Weights Not Included

Metal Wheel Weight Floor Rack

SKU 1328027
PLM486-31280 **449.99**

- All Metal Construction
- 8 Shelves
- Includes Dividers



Clip-On Wheel Weights

- Easy to Apply and Remain Firmly in Place Once Installed
- Steel Weights are More Environmentally Friendly Compared to the Lead Weight Alternative

- Polymer Coated for the Best Appearance and Exceptional Corrosion Resistance
- 1 Box of 25 Each



STORE STOCKED*

SKU	Part #	Profile	Price
1359082	23246	10 gm. IWFE	3.99
1359087	23248	15 gm. IWFE	5.99
1359077	23271	20 gm. IWFE	7.99
1359098	23273	25 gm. IWFE	9.99
1359089	23277	30 gm. IWFE	11.99
1359075	23283	35 gm. IWFE	13.99
1359040	23290	40 gm. IWFE	14.99
1359084	23294	45 gm. IWFE	16.99
1359043	23297	50 gm. IWFE	18.99
1417848	23301	55 gm. IWFE	20.99
1414943	23310	60 gm. IWFE	22.99
382841	23217*	0.25 Oz. MCFE	9.99
382842	23219*	0.50 Oz. MCFE	10.99
382843	23220*	0.75 Oz. MCFE	11.99
382844	23221*	1.00 Oz. MCFE	13.99
382845	23227*	1.25 Oz. MCFE	17.99
382846	23230*	1.50 Oz. MCFE	17.99
1359096	23244	1.75 Oz. MCFE	20.99
1359053	23253	2.00 Oz. MCFE	21.99
1359056	23257	2.25 Oz. MCFE	23.99
1359052	23260	2.50 Oz. MCFE	26.99
1359095	23262	2.75 Oz. MCFE	28.99
1359036	23263	3.00 Oz. MCFE	31.99
382853	23218*	0.25 Oz. PFE	6.99
382919	23223*	0.50 Oz. PFE	8.99
382920	23224*	0.75 Oz. PFE	8.99
382921	23225*	1.00 Oz. PFE	10.99
382922	23226*	1.25 Oz. PFE	12.99
382923	23228*	1.50 Oz. PFE	14.99
382924	23229*	1.75 Oz. PFE	15.99
382925	23232*	2.00 Oz. PFE	16.99

SKU	Part #	Profile	Price
1359093	23235	2.25 Oz. PFE	23.99
1359086	23236	2.50 Oz. PFE	26.99
1359058	23237	2.75 Oz. PFE	28.99
1359069	23259	3.00 Oz. PFE	31.99
1359038	23239	10 gm. FNFE	3.99
1359073	23242	15 gm. FNFE	5.99
1359092	23265	20 gm. FNFE	7.99
1359068	23267	25 gm. FNFE	9.99
1359071	23269	30 gm. FNFE	11.99
1359063	23270	35 gm. FNFE	13.99
1359083	23272	40 gm. FNFE	14.99
1359057	23274	45 gm. FNFE	16.99
1359094	23275	50 gm. FNFE	18.99
1359070	23276	55 gm. FNFE	20.99
1417552	23309	60 gm. FNFE	22.99
383021	23222*	0.25 Oz. ALFE	9.99
383022	23231*	0.50 Oz. ALFE	10.99
383023	23233*	0.75 Oz. ALFE	14.99
383029	23234*	1.00 Oz. ALFE	15.99
1359044	23243	1.25 Oz. ALFE	18.99
1359078	23247	1.50 Oz. ALFE	19.99
1359076	23249	1.75 Oz. ALFE	20.99
1359037	23250	2.00 Oz. ALFE	21.99
1359048	23252	2.25 Oz. ALFE	23.99
1359074	23287	2.50 Oz. ALFE	26.99
1359047	23289	2.75 Oz. ALFE	28.99
1417555	23302	3.0 Oz. ALFE	31.99
1359054	23238	0.25 Oz. TFE	9.99
1359064	23241	0.50 Oz. TFE	10.99
1359091	23255	0.75 Oz. TFE	12.99
1359049	23256	1.00 Oz. TFE	14.99

SKU	Part #	Profile	Price
1359039	23258	1.25 Oz. TFE	18.99
1359088	23261	1.50 Oz. TFE	19.99
1359080	23264	1.75 Oz. TFE	20.99
1359059	23266	2.00 Oz. TFE	21.99
1359060	23268	2.25 Oz. TFE	23.99
1359079	23284	2.50 Oz. TFE	26.99
1359066	23286	2.75 Oz. TFE	28.99
1359062	23288	3.00 Oz. TFE	31.99
1359097	23251	10 gm. ENFE	3.99
1359067	23254	15 gm. ENFE	5.99
1359081	23278	20 gm. ENFE	7.99
1359051	23279	25 gm. ENFE	9.99
1359045	23280	30 gm. ENFE	11.99
1359090	23282	35 gm. ENFE	13.99
1359061	23293	40 gm. ENFE	14.99
1359050	23296	45 gm. ENFE	16.99
1414944	23299	50 gm. ENFE	18.99
1414942	23300	55 gm. ENFE	20.99
1414945	23308	60 gm. ENFE	22.99
1359055	23240	0.25 Oz. LHFE	9.99
1359085	23245	0.50 Oz. LHFE	10.99
1359042	23281	0.75 Oz. LHFE	12.99
1359072	23285	1.00 Oz. LHFE	14.99
1359065	23291	1.25 Oz. LHFE	18.99
1359041	23292	1.50 Oz. LHFE	19.99
1359046	23295	1.75 Oz. LHFE	20.99
1414947	23298	2.00 Oz. LHFE	21.99
1414946	23303	2.25 Oz. LHFE	23.99
1417553	23304	2.50 Oz. LHFE	26.99
1417556	23305	2.75 Oz. LHFE	28.99
1417554	23306	3.00 Oz. LHFE	31.99

Wheel Weight Profile



Prices subject to change without notice. Prices do not include applicable taxes, vehicles, tires, rims, installation or optional equipment as shown. Please do not return purchases to the store. For information regarding warranty, repair, or any questions or concerns, call 901-300-4878.

BRAKE SERVICE

FOR HELP with Selection, Confirm Availability and Ordering Instructions, Call 901-300-4878

Brake Lathe Kit

PRO-CUT
BRAKE SOLUTIONS

Combination Bench Lathe Kit

SKU OSB PCTB-17K **17,339⁹⁹**

- Features Adapters and Accessories for All Passenger Vehicles and Light Trucks
- Resurfaces Brake Drums and Discs to Exceed OEM Specs for Surface Finish in 1 Pass
- Switch from Drums to Rotors in Seconds
- Includes: Dust Collection System and Side Work Table

On-Site Installation and Training Included

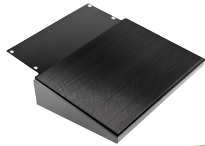

PCT50-4720



PCT50-4280



PCTB-17K

WARRANTY: 2 Years Parts and Labor

BONUS VALUE: \$1,059.99

Quick Chuck Kit

PCT50-4250K

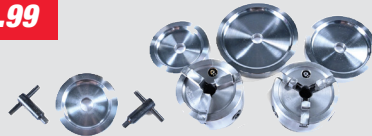

With Purchase of PCTB-17K

Offer Good While Supplies Last Through September 30, 2026

Lathe Package with Trolley

PRO-CUT
BRAKE SOLUTIONS

On Car Brake Lathe for Car and Light Truck

SKU OSB PCTX15-6ADP **18,249⁹⁹**

- Plug In, Variable Speed 48v DC Motor
- Performance Plus Cutting Head
- PFM 2.0 Electronics
- Patented One Touch Lateral Run Out (LRO) Compensation
- Cross Platform Compatible Computer and Wiring Harness
- 6 LED On-Board Work Light
- 4 Wheel, 4 Axis, Adjustable Trolley

On-Site Installation and Training Included

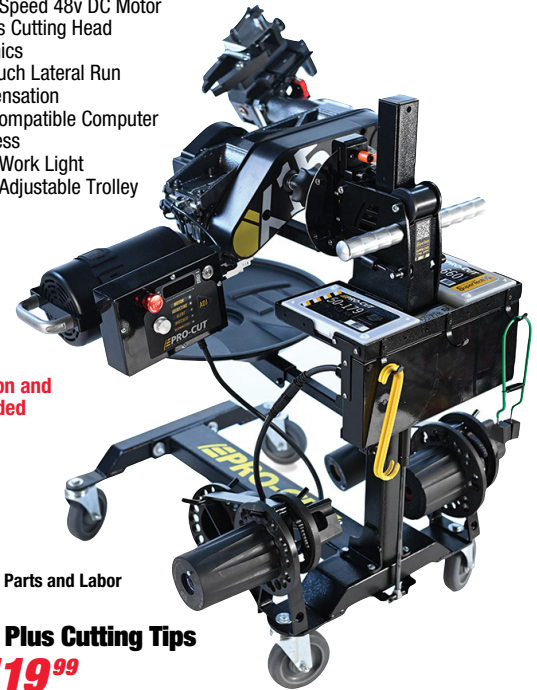

WARRANTY: 2 Years Parts and Labor

Performance Plus Cutting Tips

SKU OSB PCT50-778 **119⁹⁹**

- Includes: 6 Tips with Screws

TEST DRIVE BEFORE YOU PURCHASE!

901-300-4878

Ranger®

RL-8500 Combination Brake Lathe with Bench and Standard Tooling

SKU 901827 RANRL8500 **10,769⁹⁹**

- Complete Kit Includes: Lathe, Standard Adapters and Bench
- Provides a Faster, More Accurate and Easier Resurfacing Capability Than Any Other Brake Lathe in Its Class
- Infinitely Variable Speed Controller Able to Turn Rotors and Drums
- Quick-Change Adapter-Plus System with Built-In Springs Eliminates the Need for Conventional Bell Clamps and Cones
- Independent DC Servo Motors Control the Cross-Feed and Spindle-Feed Drives
- One-Cut Micro Finish
- 150 or 200 RPM Spindle

RL-8500XLT HD Combination Brake Lathe with Bench and Standard Tooling

SKU 1275463 RANRL8500XLT **12,379⁹⁹**

WARRANTY: 1 Year Parts and Labor

Leasing Terms Available, Ask Your AutoZone® Commercial Sales Manager.



RANRL8500

Shown with Optional Equipment. Accessories Not Included.

Ranger

Truck Adapter Package

SKU 899411 RAN5150161 **2,599⁹⁹**

- Super-Duty Truck Tooling Package Consists of an Upgraded 1-7/8" Arbor and a Wide Variety of Adapters
- 32 Piece Set Allows Expanded Coverage to Handle Any Vehicle Up to 1 Ton Trucks
- Fits RL-8500 and RL-8500XLT



Customer Responsible For Offloading, Liftgate Service Available.

For OSB, Call 901-300-4878

BRAKE SERVICE

TO ORDER, contact your Commercial Sales Manager or go to AutoZonePro.com

BRAKE SERVICE

Brake Service Tools

2 Piece Steel Line Stopper Set

SKU 1331483 **19⁹⁹**
35057

- Seals Steel Lines Found on Fuel, Brake, AC, Power Steering, Transmission Cooling Lines and Banjo Lines
- Prevents Leaks and Contamination
- For Use with All Automotive Fluids
- Fits 3/8", 1/2", 5/16" and Banjo Lines



Power Steering Bleeder Set

SKU 434716 **26⁹⁹**
27311

- Eliminate Trapped Air in Power Steering and Brake Systems Following Repairs or Fluid Changes
- Works with a Hand Vacuum Pump That Can Be Coupled to the Adapter
- Includes: 2 Tapered Rubber Adapters to Fit Most Power Steering Pumps and Reservoirs



8 Piece Brake Tool Set

SKU 900827 **69⁹⁹**
27194

- Includes: Spring Compressor, Brake Spring Installer, Spring Removal Tool, Brake Retaining Spring Tool, Brake Spring Pliers, 2 Brake Adjustment Spoons and Mini Adjustment Spoon

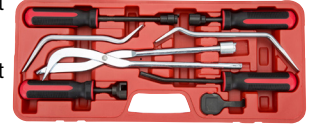

Brake Cylinder Retainer Remover

SKU 265111 **17⁹⁹**
25268

- Expands and Holds Special Retainer So the Brake Cylinder May Be Removed
- Releases the Spring Clip Retainer That Attaches the Rear Brake Cylinder to Backing Plate



8 Piece Brake Caliper Hanger Set

SKU 312538 **34⁹⁹**
24518

- Prevents Kinking or Premature Failure of Brake Hose
- Keeps Calipers Up and Out of the Way When Servicing Suspension Components, Brakes, etc.
- Hi-Vis Green Powder Coat So You Won't Misplace Them or Leave Them Attached to the Vehicle



8 Piece Manual Brake Gauge Set

SKU 191672 **19⁹⁹**
25266

- Color Coded Brake Gauge Identifies Thickness Levels for Brake Lining Inspection
- Includes Sizes: Red: 2, 3 mm, Yellow: 4, 5, 6 mm, Green: 8, 10, 12 mm
- Red Indicates Must Be Serviced; Yellow Indicates Should Be Serviced; Green Indicates Good



Brake Caliper Brush

SKU 250125 **21⁹⁹**
25435

- Slim Design for Cleaning Brake Calipers and Other Brake Hardware



Multi-Purpose Tubing Bender

SKU 390889 **15⁹⁹**
25179

- Lightweight for Easy Handling
- Makes Left, Right and Offset Bends Up to 90°
- Degrees Marked for Accuracy
- Use with 1/4", 5/16" and 3/8" (4, 6 and 8 mm) Diameter of Mild Steel and Soft Tube Material



Disc Brake Pad Spreader

SKU 141493 **16⁹⁹**
25265

- For Use on Domestic and Import Cars and Light Trucks
- Made from High Carbon Steel and Chrome Vanadium Steel to Resist Corrosion



Rotor/Drum Caliper Kit

SKU 186504 **124⁹⁹**
CEN3K301

- Attaches to Any Caliper on the Lower Jaws
- Outward Facing Anvils to Inspect Drums
- Inward Pointing Anvils to Measure Rotors 8" to 13"
- Range 0 to 6" Digital Caliper Included



Electronic Digital Rotor Gage

SKU 1330687 **117⁹⁹**
CEN3M431

- Easy-to-See Digital Readout
- Long Arms for All Rotors
- Interchangeable Flat and Pointed Anvils



Disc Brake Rotor Micrometer

SKU 607071 **99⁹⁹**
25367

- .001" Accuracy, .0005" Reading
- Large LCD Display with SAE or Metric Reading
- Manual Power Off/On
- Range: 5.5"/140 mm
- Easy Glide Action
- Hardened Measurement Surface



Carbide Lathe Inserts



SKU	Part Number	Quantity	Application	Description	OEM Part No.	Price
262385	SHA0626	6 Pack	Ammco	Use on Ammco Models 1000, 1001, 3000, 4000, 4100, 7000, 7700	90614-6	37.99
262386	SHA06210	10 Pack	Ammco	Use on Ammco Models 1000, 1001, 3000, 4000, 4100, 7000, 7700	90614-10	34.99
262388	SHA1046	6 Pack	Ammco	Positive Rake Cutting Bits for Ammco Models 3850, 4000, 7000 and 7500 as well as Twin Cutter and 9381 Facing Set	906918-6	75.99
543384	SHA069-10	10 Pack	Pro-Cut	Pro-Cut Style Bit for Use on Model 610 On-The-Car Lathes for Ford. RJ West PFM 9.2, FM900, PFM 9.2DRO Warthog and 9.2DRO	50-742	124.99
262382	SHA40710	10 Pack	FMC	Use on FMC, John Bean, Barrett, Snap-On 67BSD, 67DLX, 67GSA, 69DLX, 701ECF, 601PF, 400, 500, 600, 700 Disc/Drum Lathes	90488, W139, D139	98.99
300786	SHA408-10	10 Pack	FMC/Ranger/Accu-turn	Ranger RL8500 and RL8500XLT Disc and Drum Cutting Lathes. FMC/Barrett Models 400, 500, 600 and 700 Lathes	45016	114.99
262383	SHA06010	10 Pack	Accu-turn	Use on Models: 7700, 8920, 8922, 8944, 8989, 8990, 8991, 8993, 8995 and 8997 Brake Lathes. 3 Cutting Edges	433796	110.99
1142331	SHA065-10	10 Pack	Hunter	Use on Rotor Models: BL500, 501 and 505 Hunter Lathes	221-639-3	149.99

Silencer Bands



Large Solid Rotor Silencer Band (9")

SKU 262396 **14⁹⁹**
SHA94



Small Solid Rotor Silencer Band (6")

SKU 262393 **14⁹⁹**
SHA96

Silencer Clamp

SKU 388821 **65⁹⁹**
SHA70B



Ammco Style Disc Silencer Band with Steel Weights

SKU 262392 **44⁹⁹**
SHA69



Ammco Style 1-3/4" Drum Silencer Band

SKU 262390 **69⁹⁹**
SHA80B

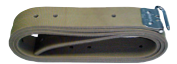

See AutoZonePro.com for More Applications

Prices subject to change without notice. Prices do not include applicable taxes, vehicles, tires, rims, installation or optional equipment as shown. Please do not return purchases to the store. For information regarding warranty, repair, or any questions or concerns, call 901-300-4878.

AZG0326

111

BRAKE SERVICE

Brake Bleeding Tools

OEM TOOLS

Vacuum Pump Tester, Power Steering and Brake Bleeder Kit

SKU 1103570 **69⁹⁹**
37070

- Includes: Vacuum Pump Reservoir Jar with Transfer Lid, Storage Lid, Brake Bleeding Adapter Package, Steering Pump Adapters and Tubing Pump with Vacuum Gauge and Accessories



1 Liter Pneumatic Vacuum Brake Bleeder with Refill Bottle

SKU 1282750 **54⁹⁹**
22505 REG. \$64.99

SAVE \$10

- Convenient Single-Person Operation
- Effective for Use on Disc/ Drum Brakes and Clutches
- Auto-Refill Kit to Simplify the Master Cylinder Refill
- Uses a Standard Workshop Air Supply



Offer Good Through September 30, 2026

Universal Fluid Dispensing Bottle

SKU 568477 **49⁹⁹**
24443

- Refill the Master Cylinder During Vacuum or Manual Hydraulic Brake or Clutch Bleeding and Flushing
- Mounts Securely to Master Cylinder and Clamps
- Capacity: 50 Oz.



2 Liter Pneumatic Vacuum Brake Bleeder with Refill Bottle

SKU 1361989 **99⁹⁹**
22506

- For Use on Brakes and Hydraulic Clutches
- Convenient Single-Person Operation
- Uses Standard Workshop Air Supply
- Includes: Auto-Refill Kit to Simplify the Master Cylinder Refill and Adapters to Fit Most US and Domestic Vehicles
- Standard and ABS Brake Systems



Brake Bleeder, Steering Pump Bleeder and Vacuum Pump Test Kit

SKU 1142597 **64⁹⁹**
27070

- Kit Bleeds Brakes, Clutches and Other Hydraulic Systems
- Includes: Vacuum Pump Reservoir Jar with Transfer Lid, Storage Lid, Brake Bleeding Adapter Package, Steering Pump Adapters and Tubing



Master Cylinder Adapter Cap Update Kit

SKU 1544667 **279⁹⁹**
MITMVA6855

- Includes: 2 Honda Caps, 1 Tesla Cap, 1 Nissan/Infiniti Hybrid Cap, 2 Ford Caps, 1 Ford/Tesla Cap, and 3 Down Tubes for Caps
- For Both EV and Hybrid Vehicles
- Update Kit Combined with MVA6850 Covers Most Hybrid and Electric Vehicle Brake Pressure Bleeding Applications
- Expands Our Cap Offerings for Brake Bleeding
- Can Be Used with All MityVac Manual and Pneumatic Pressure Pumps



DIY Reverse Brake and Clutch Bleeder

SKU 459112 **64⁹⁹**
PHO2104-B

- Easily Bleeds ABS
- Removes Trapped Air
- Attachments to Fit All Vehicles



5 Piece Brake Bleeder Wrench Set

SKU 1442597 **53⁹⁹**
VIMBB500

- Sizes: 7 mm to 11 mm
- True Size Hex Openings for Tight Fit
- Satin Chrome Plated High Alloy Steel
- Angles are Designed to Access Bleeder Screws without Removing the Wheel



Brake Bleeding Kit

SKU 604208 **259⁹⁹**
MITMV6830

- Compressed Air Operation
- 1.9 Quart Capacity
- Swivel Air Inlet with Quick Disconnect



Pressure Brake Bleeding System

SKU 383099 **569⁹⁹**
MITMV6840

- Large 1.2 Gallon Capacity Dispenser
- Includes: 7 Master Cylinder Adapters That Connect to Most U.S., Asian and European Cars and Light Trucks
- Pressure Gauge Indicates Dispensing Pressure
- Utilizes Push-to-Connect, Quick-Change Adapters
- Integrated Manual Relief Valve for Safety



2.5 L Pressure Brake Bleed Kit

SKU 1361996 **609⁹⁹**
MITMV7840

- Utilizes Shop-Air to Produce Pressure for Dispensing and Vacuum for Extracting
- Pressure Control System Safely Maintains Output Pressure between 20 and 25 psi
- Includes: 7 Master Cylinder Adapters That Connect to Most Domestic and Import Cars and Light Trucks
- Conveniently Located On/Off and Flow Control Valve



Silverline Elite Test Kit

SKU 988888 **154⁹⁹**
MITMV8500

- Provides Either Vacuum or Pressure with Equal Precision and Convenience
- Performs Engine Performance Diagnostics, Brake Bleeding, Fluid Transfer, Evacuation, Sampling and More
- Includes: Components Needed to Perform Hundreds of Diagnostic and Mechanical Tests



Disc Brake Tools

18 Piece Disc Brake Caliper Set

SKU 94798 **59⁹⁹**
27113

- Includes: Caliper Adapters from 1-3/16" to 2-1/2" – Some Specifically to Service Nissan, Saab and Honda Models
- Includes: Right and Left Hand Caliper Rotation Tools
- Left Hand Thread is Useful When Working on 2004-2007 Ford Freestyle, 500, 2008 Taurus and Taurus X Models
- Rust Resistant Finish



37 Piece Disc Brake Service Kit

SKU 1125858
25107

- Includes: Disc Brake Caliper Tool Set, Pad Spreader, Brake Caliper Brush, 8 Brake Caliper Hangers, 3 Bleeder Wrenches and One-Man Brake Bleeder Kit



69⁹⁹
REG. \$125.28

SAVE OVER \$55
When You Buy the Kit

Pneumatic Brake Caliper Tool Set

SKU 1053954 **254⁹⁹**
MSC43050

- Durable Non-Impact Single Piston Shaft
- O-Ring Protected Shaft to Maintain Proper Pressure
- Magnetic Base to Secure Press Adapters
- 15 Piece Press Adapter Set



Dual Piston Press

SKU 900811 **49⁹⁹**
25741

- Designed to Press-In Single and Dual Piston Brake Calipers
- Universal Application on Cars, Light and Heavy Trucks
- Rugged Design for Longer Tool Life



Dual Speedy Pad Spreader

SKU 291420 **84⁹⁹**
LIS25750

- Compresses Dual Brake Pistons Simultaneously
- Makes Dual Piston Pad Replacement a Simple Job



Speedy Pad Spreader

SKU 291417 **64⁹⁹**
LIS24300

- Compresses Disc Brake Pistons in Seconds
- Makes Brake Pad Replacement Easier



Quick Quad Pad Spreader

SKU 080553 **109⁹⁹**
LIS29100

- A Quick Way to Spread Brake Pads and Compress Disc Brake Pistons for Pad Replacement on Single, Double and Quad Piston Calipers
- Simultaneously Compress All 4 Pistons on Quad Piston Applications
- Can Be Used While Caliper is on the Vehicle or Hanging Free



Brake Caliper Press (Standard Size)

SKU 954224 **99⁹⁹**
LNG279

- Size Range: 1.7" to 3"
- Works on Various Single, Dual and Quad Piston Calipers
- 360° Ratchet Swing Allows Access at Any Angle



Brake Caliper Press (Small Size)

SKU 1400043 **89⁹⁹**
LNG277

- Size Range: 1" to 2.25"



Brake Caliper Piston Rewind Tool

SKU 1368620 **79⁹⁹**
35058

- Includes: Standard Two-Pin Adapter Compatible with Any Piston Adapter and a Fully Adjustable 3/8" Drive 2 and 3 Pin Adapter Tool That Fits Most Vehicles
- Powerful Internal Spring to Apply Stable Pressure to the Caliper Piston



Brake Hub Resurfacing Tool

SKU 013590 **21⁹⁹**
24686

- Quickly Remove Rust on Lug Studs and Rotors on the Hub Assembly
- Use with Drill for a Quick and Easy Job
- Fits All Passenger Cars, Light Trucks and SUVs
- Includes: 4 Pads



2 and 3 Pin Brake Rewind Tool

SKU 13592 **24⁹⁹**
24693

- 2 Fully Adjustable to Fit Thousands of Vehicles
- No Need for Multiple Tools
- 3/8" Drive Adapters

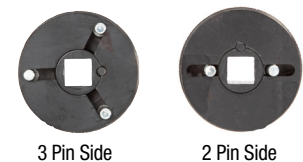

3 Pin Side

2 Pin Side

BRAKE SERVICE

Sprayers

Red Powder Coated Aluminum Sprayer

SKU 186463
MSMB8000PL **50⁹⁹**

- 16 Oz. Capacity
- Not for Use with Chlorinated Solvents
- Pressurize Up to 200 psi

Complete Repair Kit for B8000PL

SKU 186467
MSMBK50 **22⁹⁹**



Red Powder Coated Steel Sprayer

SKU 186459
MSMA1000R **92⁹⁹**

- 32 Oz. Capacity
- Not for Use with Water-Based Products
- Pressurize Up to 200 psi



Repair Kit

SKU 186465
MSMK10 **44⁹⁹**

- Used for MSMA1000R
- Includes All Parts That Can Be Replaced
- All Chemical Resistant Seals



Filler Cap Assembly

SKU 186466
MSMP156 **21⁹⁹**

- For Model "A" Sprayers
- Hand Removable

Hones

Rotor Flex-Hone®

73⁹⁹ each

- Lowers Harmonic Vibrations
- Ideal for New and Resurfaced Rotors and Flywheels

Fine

SKU 341310
BRMRMFH240Z25

Medium

SKU 341298
BRMRMFH120Z25

Coarse

SKU 341314
BRMRMFH60Z25



Flex-Hone BC 1" (25.4 mm)

SKU 341000
BRMBC10018 **26⁹⁹**

- 1" (25.4 mm) 180 Grit



Adjustable Disc Brake or Small Engine Hone

SKU 531707
25030 **12⁹⁹**

- Includes: 3 Medium (220) Grit 3/4" Stones



Brake Fluid Testers

BrakeStrip+ 100 Double Ended Coolant Strips with Customer Cards

SKU 1089037
PHO3006-PLUS **89⁹⁹**

- Double Ended Test Strips for Brake Fluid and Coolant
- Use on DOT 3 or 4 Brake Fluid
- Compatible with All Coolant Colors
- Includes: 100 Double Ended Strips and 100 Rating Scale Cards



BrakeStrip+ 100 Double Ended Coolant Strips

SKU 666577
PHO3001-PLUS **84⁹⁹**



BrakeStrip Brake Fluid Copper Test Kit

SKU 289905
PHO3006 **79⁹⁹**

- Everything Needed to Test Brake Fluid
- Know within 60 Seconds if it's Time for a Change
- Includes: 1 Tube of 100 Test Strips and 100 Color Pop Rating Cards



Brake Fluid Tester - DOT 3, DOT 4, DOT 5.1

SKU 850067
25269 **39⁹⁹**

Built-In LED Light to Ensure Tips are in Proper Contact with Fluid

- Easily, Quickly and Precisely Checks the Water Content of 8 Types of Polyglycol-Based Brake Fluids (DOT 3, DOT 4, DOT 5.1, ACDelco DOT 3, Pennzoil, Prestone, Motorcraft and Toyota DOT 3)



Electronic Brake Fluid Tester

SKU 191687
25267 **29⁹⁹**

- Checks Moisture Content in Any Brake Fluid
- Multi-Colored LED Panel for Easy Recognition
- Automatic Shut-Off
- Calibrated for DOT 4 Fluid
- Includes: (1) AAA Battery



Fluid Exchanger

Premium Brake Fluid Exchange System

SKU 1407509
MVC500-8100

3,599⁹⁹

- Includes: Brake Adapter Kit
- Pressure and Vacuum Assist
- Portable, Operates on 12 Volt DC
- Complete Brake System Exchange in 10 Minutes
- Adjustable Pressure Regulator Controls Operating Pressure
- Performs Brake Flush Using Pressure and Vacuum Simultaneously



Brake Service Tool

Heavy Duty Hub Drum and Rotor Puller Kit

SKU 1125878
25106 **139⁹⁹**

Use with Impact Wrench to Remove Hubs, Drums and Brake Rotors

- Includes 3 Hub Adapters for Use with Most Common Hub Sizes and Types
- Jaw Spread Up to 12-3/4" with 5" Reach
- Durable Forged Frame Rated to 7 Tons of Pulling Force for the Toughest Jobs
- Drum and Rotor Pulling Arms Feature with Raised Stops for Use with Ratchet Straps (Not Included)
- Easily Adjust the Arms and Set Puller in Place for Tough Pulling Jobs in Tight Spaces
- Comes in Sturdy Blow Mold Case



Scan Tools **TEXA Diagnostic Kits**

- World Class US-Based Support, with the Most Complete Vehicle Coverage
- Lifetime Repair or Replacement Equipment Warranty with Current Software Subscription
- Continual Updates on All Makes and Models with Current Software Subscription

- Fast, Powerful Hardware for Maximum Shop Efficiency
- Wiring Diagrams, Repair Procedures, Dashboards, Advanced Resets, Activations and More



Axone Light Truck Diagnostic Kit

SKU OSB
TEXAXLTHDTRK **5,029⁹⁹**

- Advanced Diagnostics and OE-Level Coverage for Heavy-Duty Truck, Trailer, and Light Commercial Vehicles
- Includes: AXONE NEMO LIGHT, Suitable for a Large Range Of Environments and the TXT Multihub



Axone Plus Truck Diagnostic Kit

SKU OSB
TEXAXPLHTRK **7,499⁹⁹**

- Advanced Diagnostics and OE-Level Coverage for Heavy-Duty Truck, Trailer, and Light Commercial Vehicles
- Includes: AXONE NEMO PLUS, Suitable for a Large Range Of Environments and the TXT Multihub



Axone Plus Master Fleet Package for Truck/OHW/Car

SKU OSB
TEXAXPLMFP **11,999⁹⁹**

- Provides Advanced Diagnostics and OE-Level Coverage for Diverse Fleets Including Car, Truck, Agriculture and Construction Equipment
- Includes: AXONE NEMO PLUS, Suitable for a Large Range Of Environments, the TXT Multihub and the Off-Highway Essential Cable Case



For OSB, Call 901-300-4878

Smoke Leak Detector



Dual Evap Smoke Machine*

SKU OSB
MSC43065 **1,579⁹⁹**

- For Evap, Turbo/Intake and Heavy Duty Truck Testing*
- For Evap and High Pressure Diagnostic Testing
- Multiple Options for Smoke Injection Include Built-In Internal Compressor, Shop Air and Inert Gases
- Accessories Include: Smoke Hose, Block Off Caps, Exhaust Cone, Schrader Valve Remove/Installer, Evap Service Port Adapter Hose, Smoke Illuminating Flashlight, Smoke Producing Fluid and Bladder



* Heavy Duty Truck Testing Requires MSC43062 Adapter Kit, Not Included (Sold Separately)

Cooling System



Heavy Duty Cooling Kit

SKU 954231
MSC43306 **514⁹⁹**

- For Use with Freightliner, International, Kenworth, Peterbilt, Mack, Volvo, GMC and Sterling Cooling Systems
- Uses Shop Air to Pressure Check and Vacuum Refill
- 4 Quick-Disconnect Vacuum Attachments Provide Quick Refilling of the Cooling System and Eradicates Airlocks
- Includes: Heavy Duty Vehicle Adapters, Pressure Test Regulator, Vacuum Refill Attachment with Tubing in a Plastic Case



Recovery Machine



Fully-Automatic Heavy Duty R134a Refrigerant Management System

SKU 1407805
CPSMXHD **7,619⁹⁹**

- For Commercial and Heavy Duty Applications
- 6 CFM Dual-Stage Vacuum Pump
- Large 12.67 CC Twin-Piston Oilless Compressor
- Comes Standard with a 50 Lb. Tank; Upgradeable to 90 Lb.
- Wi-Fi and Bluetooth Enabled



Specialty Tools

NAVISTAR® MAXXFORCE® Fuel Line Disconnect Tool Set - 4 Piece

SKU 004112
25031 **41⁹⁹**

- For Series 11 and 13 Engines
- Sized to Depress Fuel Release Tabs for Efficient Fuel Line Removal
- 1 Straight and (1) 90° Tool for 11.8 mm Fuel Lines; 1 Straight and (1) 90° Tool for 16 mm Fuel Lines



Heavy Duty U-Joint Puller

SKU 041474
24538 **134⁹⁹**

- Easily Removes Seized U-Joint Cups on Most Class 7 and 8 Trucks
- Safely Disassemble Drivelines without Hammering or Heating Components
- Does Not Damage the Driveshaft, Yokes, Joints or Bearing Cups
- Bearing Cup Outside Diameter: 1.5" to 2.2"



Automatic Slack Adjuster Release Tool and Wrench

SKU 1207889
25252 **40⁹⁹**

- 5/16" Double Square Ratchet Has an Angled Head to Give Extra Clearance for Hands
- Side-Mounted Forward/Reverse Lever for Easy Operation
- Speeds Up Installation on Meritor® Heavy Duty Truck Brake Slack Adjusters to Simplify Brake Service



Brake Anchor Pin Press **OEM TOOLS®**

SKU 1361998
27090 **175⁹⁹**

- For Removal of Brake Anchor Pins and Bushings on 16-1/2" S-Cam Trailer and Tractor Q Brake Systems
- No Need to Remove the Hub or Dust Shield
- Rigid C-Frame with 10 Ton Capacity
- Manufactured from High Grade Steel for Strength and Durability
- Manual, No Hydraulics Required



HEAVY DUTY

Heavy Duty Wheel and Tire Service

Heavy Duty Truck Tire Changer

SKU **OSB**
ROTR501PLUS 28,219⁹⁹

- Dismount and Mount a Truck Tire in 30 Seconds
- Super Fast Truck Tire Changer
- Adjustable Arm Position
- Max. Tire Diameter: 52"
- Quick Loading

INCLUDES: Set Up and Training

WARRANTY: 3 Years Parts and Labor



R544 Plus Pro Truck 3D Wheel Balancer

SKU **OSB**
ROTR544P 15,739⁹⁹

- Wheel Diameter: 10" to 30"
- Tire Width: 1.5" to 22"
- Maximum Tire Diameter: 51"
- Passenger/LT Truck/HD Capable with Standard Adapters
- Max. Rim Diameter: 30"
- Max. Tire Diameter: 51"

INCLUDES: Set Up and Training

WARRANTY: 3 Years Parts and Labor



CHD-6330 Heavy Duty Tire Changer

SKU **OSB**
AMM8006330 23,049⁹⁹

- Motor: 2 HP
- Max. Tire Diameter: 63"
- Rim Diameter: 13" to 27"
- 4-Jaw Chuck Allows for Fast and Easy Clamping of Virtually All Rim Styles
- Features Portable Control Station
- Solid, Single Piece Frame for Added Capacity and Dependability

INCLUDES: Manufacturer's Set Up

WARRANTY: 1 Year Parts and 6 Months Labor



6450-3D Heavy Duty Balancer

SKU **OSB**
AMM64503DKT1P 20,499⁹⁹

- **Kit Includes Wheel Lift Plus Lug and Hub Centered Budd Style Adapters**
- Dual Calibration Software Stores and Runs Two Independent Sets of Calibrations
- Powerful 1.5 HP Direct Drive Motor Shaves 20 Seconds Off of a Typical 22.5" Spin
- Designed for High Volume Balancing, the Perfect Machine for Delivery Vehicles and Tractor Trailers
- Max. Tire Diameter: 52"
- Max. Tire Weight: 500 Lb.

INCLUDES: Manufacturer's Set Up

WARRANTY: 1 Year Parts and 6 Months Labor



Super-Duty Truck Tire Changer

SKU **544552**
RANR26FLT 12,799⁹⁹

- Super-Duty Electric Motor and Hydraulic Drive for Superior Torque and Wheel Holding Power
- Heavy, Tapered Roller Bearings and a Dual Direction Hydraulic Motor Provide Smooth Torque
- Self-Centering Hydraulic Clamping Chuck
- Quick Positioning and Locking Mount/Demount
- Hydraulically Operated Spreader Jaws
- Voltage: 208V to 230V; 60Hz
- Max. Rim Diameter: 14" to 26"
- Max. Tire Diameter: 63"



RB30T Heavy-Duty Truck Wheel Balancer with Adapter Kit

SKU **OSB**
RANRB30T 14,099⁹⁹

- Five Distinct Balancing Modes: Dynamic, Static, ALU1, ALU2, and ALUS for Total Compatibility with Steel and Aluminum Wheels
- Integrated Pneumatic Wheel Lift Handles Up to 330 Lb. for Easy Mounting and Reduced Strain on Technicians
- High-Precision 64-Bit Digital Architecture and Single-Chip Control System for Ultra-Fast Data Processing
- Rugged 40 mm Precision-Machined, Hardened-Steel Shaft Ensures Long-Term Durability and Repeatable Clamping
- Supports Wheels Up to 49.25" in Diameter, 20" Wide, and Up to 330 Lb. in Weight
- Dual-Unit Display Allows User Preference Between Gram/Ounce and Inch/Millimeter Readouts
- Max. Wheel Diameter: 30"
- Max. Tire Diameter: 50"



Customer Responsible For Offloading, Liftgate Service Available.

For OSB, Call 901-300-4878

- Free Delivery in 48 Continental United States
- Specifications Subject to Change without Notice or Liability
- Equipment Lead Times and Shipping May Vary
- Customers Responsible for Offloading Equipment Upon Arrival
- Leasing Terms Available. Ask Your AutoZone® Commercial Sales Manager.

HEAVY DUTY

FOR HELP with Selection, Confirm Availability and Ordering Instructions, Call 901-300-4878

HEAVY DUTY

Heavy Duty Lifts

14,000 Lb. Mobile Lift, Single Column

SKU 1580895
CHLCLHM-140 **12,719⁹⁹**

- 110 Volt Charging System
- Completely Wireless System
- Adjustable Wheel Carriage Adapts from 5" to 24.5"
- Integrated Touch-Screen Control Console at Each Column Allows Operation from Any Unit
- 14,000 Lb. Capacity per Column
- Includes: Batteries, Fluids and Factory Training

WARRANTY: 2 Years Parts and 1 Year Labor

CL Challenger Lifts



New AGM Batteries Carry a 2 Year Free Replacement Warranty

27,000 Lb. Heavy Duty Truck Lift

SKU OSB
BENHDS27 **23,499⁹⁹**

- Runways Include Rail-Kit for Optional Accessories
- Runways Adjust for Different Tread Widths
- Electric/Hydraulic Power System
- Fully Enclosed Lifting Cables, Safety Locks and Sheaves
- Pneumatic Push-Button Safety Release
- Length: 24-3/4'

WARRANTY: 1 Year Parts and Labor

BendPak



Customer Responsible For Offloading.

For OSB, Call 901-300-4878

Lifting Equipment

6,000 Lb. Heavy Duty Engine Crane

SKU 1267948
AFF3584

1,579⁹⁹

- 4 Different Boom Settings: 3, 2, 1.5 and 1 Ton
- Rear of Crane: 61.5" Tall and 33" Wide
- Distance Between Front of Legs: Retracted 23", Extended 28.5"



35 Ton Air Hydraulic Axle Jack

SKU 954200
AFF536 **1,869⁹⁹**

- Unique Motor Design Advances Ram to Load Faster
- Air Assisted Lowering and Dual Return Springs Provide Controlled and Easy Descent
- Safety Overload System Prevents Jack from Being Used Beyond its Rated Capacity
- Corrosion Resistant Aluminum and Nylon Composite Air Motor



4,400 Lb. Transmission Jack

SKU 954183
AFF3180A **1,849⁹⁹**

- Heavy Duty with a Rated Capacity of Over 2 Tons
- Rugged Industrial Grade 4" Casters
- Fully Adjustable Saddle
- Extra-Long 32" Handle
- Safety Chain Included
- 8.5" Low Height
- Convenient Side Tray to Store Small Tools and Parts



10 Ton Air/Hydraulic Service Jack

SKU OSB
AFF3135 **1,969⁹⁹**

- Large, Rugged 4-1/2" Front Wheels and 2-3/4" Rear Casters
- Can Be Operated Manually When Shop Air is Not Available
- Foot-Operated Pump for Quick Lifting Efficiency
- Automatic Overload Safety Valves
- Chassis Length: 61"
- Low Height: 7"
- Width: 18"



Locknut Sockets

OEM TOOLS

7 Piece Wheel Bearing Locknut Set

SKU 1207886
37385 **119⁹⁹**

- Includes: 55 mm 6PT, 2-3/8" 6R, 2-3/8" 6PT, 2-1/2" 6R, 2-1/2" 6PT, 2-9/16" 6R and 2-3/4" 6R
- Comes with Standard Hex (6PT) and Rounded (6R) Hex Sockets to Fit Many Applications
- For Use with 1/2" Square Drive Ratchet, Breaker Bar or Torque Wrench



5 Piece Budd Wheel Socket Set

SKU 1207878
37384 **179⁹⁹**

- 35 mm, 38 mm, 41 mm and 1-1/2" Sockets Feature a Dual Socket Design with a Hex to Remove the Lug Nut and an Internal Square Drive to Remove the Inside Wheel
- 38 mm, 41 mm and 1-1/2" Sockets Each Have a 13/16" Internal Square
- 35 mm Socket Has a 11/16" Internal Square
- For Use with 1" Drive Ratchet, Breaker Bar, Torque Wrench and Impact Wrench



Truck Axle Wheel Bearing Sockets

- 3/4" Square Drive
- Constructed with High-Grade Steel for Strength



4", 6 Pt.
SKU 466541 **41⁹⁹**
25482

2-9/16", 8 Pt.
SKU 466534 **27⁹⁹**
25473

4-1/8", 6 Pt.
SKU 265085 **49⁹⁹**
25483

4-3/8", 8 Pt.
SKU 466543 **49⁹⁹**
25485

Heavy Duty Stands

22 Ton Heavy Duty Axle Stands (Pair)

SKU 757098
24854 **249⁹⁹**

- Min. Height: 12-1/4"
- Max. Height: 19-3/4"
- Adjustable Pin Design
- Features Handle for Transport and Positioning
- Large Shaped Saddles Center Lift Points for Secure Placement



OEM TOOLS

Heavy Duty Truck Oil Filter Wrenches

OEM TOOLS

Small
SKU 344322 **34⁹⁹**
25231
• Range: 4-1/8" to 4-5/8"
(104 to 118 mm)

Medium
SKU 344323 **34⁹⁹**
25232
• Range: 4-5/8" to 5-1/4" (118 to 134 mm)

Large
SKU 344324 **39⁹⁹**
25233
• Range: 5-1/4" to 5-3/4"
(134 to 142 mm)



25231

- Free Delivery in 48 Continental United States
- Specifications Subject to Change without Notice or Liability
- Equipment Lead Times and Shipping May Vary
- Customers Responsible for Offloading Equipment Upon Arrival
- Leasing Terms Available. Ask Your AutoZone® Commercial Sales Manager.

Prices subject to change without notice. Prices do not include applicable taxes, vehicles, tires, rims, installation or optional equipment as shown. Please do not return purchases to the store. For information regarding warranty, repair, or any questions or concerns, call 901-300-4878.

AZG0326

117

TOOL STORAGE



- 24" Deep Drawers
- 100/200 Lb. Drawer Capacity
- Non-Slip PVC Drawer Liners
- UV Protected Finish
- Constructed with 16 G Steel Frame
- Lift Latch Drawer Pulls

ALSO AVAILABLE IN



Homak

72" 16 Drawer Rolling Cabinet with Stainless Steel Top – Green

SKU 1267935
HOM72RSPRCSG

2,799⁹⁹

- 72" (W) x 24" (D) x 40" (H)

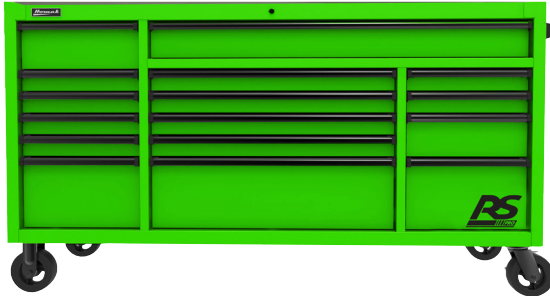

54" 10 Drawer Rolling Cabinet with Stainless Steel Top – Blue

SKU 1343816
HOM54RSCABSBL

2,129⁹⁹

- 54.5" (W) x 24" (D) x 40.375" (H)



72" 3 Drawer Hutch – Black

SKU OSB
HOM72RSPHUTBK

1,649⁹⁹

- 71.5" (W) x 23.5" (D) x 24.375" (H)



54" Top Hutch – Blue

SKU 1343820
HOM54RSPHUTBL

1,249⁹⁹

- 54" (W) x 23.5" (D) x 24.375" (H)



72" 16 Drawer Roller Cabinet – Black

SKU OSB
HOM72RSPRCBBK

2,549⁹⁹

- 72" (W) x 24" (D) x 39.25" (H)



54" 10 Drawer Rolling Cabinet – Blue

SKU 1442581
HOM54RSPCABBL

1,949⁹⁹

- 54.5" (W) x 24" (D) x 40.375" (H)



72" 12 Drawer Top Chest – Blue

SKU OSB
HOM72RSPCHSTOBL

1,779⁹⁹

- 72" (W) x 23.5" (D) x 21.375" (H)



54" 8 Drawer Top Chest – Black

SKU OSB
HOM54RSCHSTBK

1,359⁹⁹

- 54" (W) x 23.5" (D) x 21.375" (H)



72" 16 Drawer Roller Cabinet – Blue

SKU OSB
HOM72RSPRCBBL

2,549⁹⁹

- 72" (W) x 24" (D) x 39.25" (H)



54" 10 Drawer Rolling Cabinet – Black

SKU OSB
HOM54RSPCABBK

1,929⁹⁹

- 54.5" (W) x 24" (D) x 40.375" (H)



Customer Responsible For Offloading, Liftgate Service Available.

For OSB, Call 901-300-4878

- Free Delivery in 48 Continental United States
- Specifications Subject to Change without Notice or Liability
- Equipment Lead Times and Shipping May Vary
- Customers Responsible for Offloading Equipment Upon Arrival
- Leasing Terms Available, Ask Your AutoZone® Commercial Sales Manager.

TOOL STORAGE

FOR HELP with Selection, Confirm Availability and Ordering Instructions, Call 901-300-4878

TOOL STORAGE



- 24" Deep Drawers
- 100/200 Lb. Drawer Capacity
- Non-Slip PVC Drawer Liners
- UV Protected Finish
- Constructed with 16 G Steel Frame
- Lift Latch Drawer Pulls

ALSO AVAILABLE IN



44" 8 Drawer Power Service Cart – Gray

SKU 1282738
HOMRSPRO44G **1,769⁹⁹**

- Top Till Includes Full-Extension Gas Struts and a Lockable Security Compartment with an Additional Power Strip to Store and Charge Phones, Laptops and Other Devices
- Equipped with High Security Locking System to Keep Valuables Safe and Secure
- 40.5"(W) x 23.9"(D) x 40.2"(H)

Features 4 Electric Outlets and 2 USB Ports to Efficiently Charge, Store and Organize Power Tools in One Place



54" 7 Drawer Rolling Workstation - Blue

SKU OSB
HOM54RWSBL **1,669⁹⁹**

- Durable Stainless Steel Work Surface
- Four (4) 5x2" Casters with a Weight Capacity of 520 Lb. Each: 2 Swivel Locking and 2 Fixed
- 57.5"(W) x 29"(D) x 41"(H)

Features 4 Electric Outlets and 2 USB Ports to Efficiently Charge, Store and Organize Power Tools in One Place



35" 4 Drawer Slide Top Cart – Blue

SKU 1343821
HOM35STCBL **784⁹⁹**

- 35"(W) x 20.625"(D) x 42"(H)



35" 7 Drawer Flip-Top Service Cart - White

SKU OSB
HOM35FTSCWH

1,189⁹⁹

- 31"(W) x 22.5"(D) x 38.875"(H)



30" 1 Drawer Service Cart Black

SKU OSB
HOM30SCBK **359⁹⁹**

- 30"(W) x 15.875"(D) x 35.75"(H)



32" Professional 1 Drawer Service Cart - Blue

SKU 1343817
HOM32PSCBL

359⁹⁹

- 31.5"(W) x 17.5"(D) x 35.625"(H)



35" Professional 4 Drawer Flip Top Service Cart - Red

SKU 1343822
HOM35PSCR

789⁹⁹

- 35"(W) x 20.5"(D) x 39.375"(H)



34" Professional 3 Drawer Service Cart - Blue

SKU OSB
HOM34PSCBL

684⁹⁹

- 34.5"(W) x 16.75"(D) x 39.375"(H)



Customer Responsible For Offloading, Liftgate Service Available.

For OSB, Call 901-300-4878

- Free Delivery in 48 Continental United States
- Specifications Subject to Change without Notice or Liability
- Equipment Lead Times and Shipping May Vary
- Customers Responsible for Offloading Equipment Upon Arrival
- Leasing Terms Available, Ask Your AutoZone® Commercial Sales Manager.

Prices subject to change without notice. Prices do not include applicable taxes, vehicles, tires, rims, installation or optional equipment as shown. Please do not return purchases to the store. For information regarding warranty, repair, or any questions or concerns, call 901-300-4878.

AZG0326

119

TOOL STORAGE

36" Slide Top 3 Drawer Tool Cart - Green

SKU 666298
24731 **1,109⁹⁹**

- Constructed with a 19 Gauge Steel Shell and 21 Gauge Steel Drawers
- Full Length Anodized Aluminum Drawer Pull
- Shallow Drawer Dimensions: 30"(W) x 18"(D) x 2.9"(H)
- Deep Drawer Dimensions: 30"(W) x 18"(D) x 6.1"(H)
- Overall Dimensions: 36"(W) x 21"(D) x 46"(H)



Access Your Most Used Tools with an OEMTOOLS Slide Top Tool Cart

28" 7 Drawer - Molded Worktop

SKU 477172
24566 **699⁹⁹**

- Dimensions: 28.3"(W) x 18.9"(D) x 40.5"(H)
- Storage Space: 9,505 Cubic Inches
- Fully Sealed Plastic Work Surface is Solvent Resistant
- Integrated Pegboard Provides Additional Storage and Organization



36" 8 Drawer **OEM TOOLS**

SKU 477134
24565 **1,099⁹⁹**

- Dimensions: 35.8"(W) x 18.9"(D) x 39.3"(H)
- Storage Space: 12,594 Cubic Inches
- Stainless Steel Work Top is Corrosion Resistant and Easy to Clean



57" 22 Drawer Professional Combo

SKU 662893
24738

4,949⁹⁹

- Total Loading Capacity: 2,697 Lb.
- Casters Rated to 880 Lb. Each
- Overall Dimensions: 57"(W) x 24"(D) x 66.5"(H)
- Storage Space: 41,466 Cubic Inches
- Drawer Space: 13,404 Sq. Inches

SAVE \$849
When you buy the combo



57" 10 Drawer Professional Chest

SKU 666333
24737 **2,599⁹⁹**

- Overall Dimensions: 57"(W) x 24"(D) x 26"(H)
- Storage Space: 14,221 Cubic Inches

57" 12 Drawer Professional Cabinet

SKU 666300
24736 **3,199⁹⁹**

- Overall Dimensions: 57"(W) x 24"(D) x 40.5"(H)
- Storage Space: 22,528 Cubic Inches

Part #	Description	Price
24737	57" 10 Drawer Professional Chest	\$2,599.99
24736	57" 12 Drawer Professional Cabinet	\$3,199.99
	Regular Price	\$5,799.98
24738	COMBO PRICE	\$4,949.99
	SAVINGS	\$849.99



Utility Carts

30" 2 Shelf Utility Cart

SKU OSB
HOMPP06032021 **214⁹⁹**

- Load Capacity Up to 300 Lb.
- Tray-to-Tray Distance of 22.4"
- Four 4" x 1" Casters: Two Swivel, Two Fixed



2 Shelf Utility Cart

- Load Capacity Up to 300 Lb.
- Four 4" x 1" Casters: Two Swivel, Two Fixed

30"
SKU OSB
HOMPP06039021
239⁹⁹

- Tray-to-Tray Distance: 23.6"

36"
SKU OSB
HOMPP06046021
299⁹⁹

- Tray-to-Tray Distance: 24"



30" 3 Tier Utility Cart

SKU 1414408
HOMPP06032031
269⁹⁹

- Load Capacity Up to 300 Lb.
- Tray-to-Tray Distance of 16.1"
- Four 4" x 1" Casters: Two Swivel, Two Fixed



Customer Responsible For Offloading, Liftgate Service Available.

For OSB, Call 901-300-4878

- Free Delivery in 48 Continental United States
- Specifications Subject to Change without Notice or Liability
- Equipment Lead Times and Shipping May Vary
- Customers Responsible for Offloading Equipment Upon Arrival
- Leasing Terms Available, Ask Your AutoZone® Commercial Sales Manager.

TOOL STORAGE

FOR HELP with Selection, Confirm Availability and Ordering Instructions, Call 901-300-4878

TOOL STORAGE

72" Stainless Steel 11 Drawer Cabinet and Upper Cabinet

SKU 1168659 **1,599⁹⁹**
OEM24615

Features:

- Dimensions: 72"(W) x 18"(D) x 71.5"(H)
- Upper Cabinet is 12"(H) x 18"(D)
- Drawer Liners Included

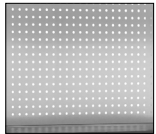

18" Tall Pegboard

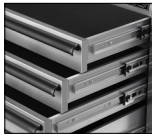

Full Extension 100 Lb. Capacity Slides



PVC Coated MDF Top



Heavy Duty Casters 5" x 2"



OEM TOOLS

Tear Down Tray

VIKING

Adjustable Mobile Work Table 200 Lb. Capacity

SKU 1485038 **199⁹⁹**
VIK52200

- Adjustable Tray
- Heavy Duty 2" Rubber Composite Swivel Casters
- Multiple Storage Slots, Trays and Insert Grooves Keeps Tools and Parts Organized and Within Reach
- 1" Drawer with Roller Bearing Slides Offer Additional Storage Capacity



Tools Not Included



Steel Workbenches

Homak

- Black Powder Coat Finish
- Engineered for Quick Assembly
- Built-In Leg Levelers

59" Steel Workbench with 2 Drawers

SKU 1392318 **614⁹⁹**
HOMGW00550170

- High Security Tubular Lock System
- Ball-Bearing Drawer Slides
- Weight Capacity: 1100 Lb.



79" Steel Workbench with 3 Drawers and Wood Top

SKU 1392314 **584⁹⁹**
HOMGS00579030

- 1.5" Wood Work Surface with Top Mat
- Weight Capacity: 440 Lb.



79" Steel Workbench with 3 Drawers

SKU 1392331 **789⁹⁹**
HOMGW00550160

- High Security Tubular Lock System
- Ball-Bearing Drawer Slides
- Weight Capacity: 1100 Lb.



Diagnostic Cart

Homak

Mobile Diagnostic and Testing Terminal

- 100 Lb. Drawer Capacity
- Diagnostic Tool Cord Management and Power Tool Storage Area
- Swivel Wheels and Large Handles for Easy Maneuverability
- EVA Drawer Liners
- 3.2 mil UV-Protected Powder Coat Finish
- Lift-Latch Drawer Pulls and Ball-Bearing Drawer Slides

Blue

SKU OSB
HOMBB06019020

639⁹⁹

Orange

SKU OSB
HOMOB06019020

639⁹⁹

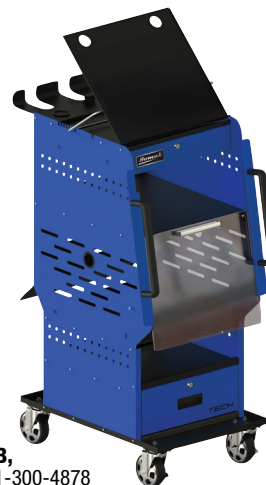

For OSB,
Call 901-300-4878

Field Boxes

SHEFFIELD

XL Field Box

- 4 Locking Options for Security
- Compression Fit Lid with Rubber Gasket for Water and Dust Resistance
- Manufactured with Impact, Abrasion and Crack Resistant Copolymer Plastics
- Food Safe and Resistant to Most Acids and Solvents
- External Dimensions: 14" (L) x 9" (W) x 9-1/4" (H)
- Internal Dimensions: 12-5/8" (L) x 6-5/8" (W) x 8" (H)

Olive Green

SKU 989218
12710

27⁹⁹



Black

SKU 1392313 **27⁹⁹** 12710

XL Field Box with Lift Out Storage Tray

- Lift-Out Tray with 8 Compartments

Olive Green

SKU 989216
12712

34⁹⁹

Black

SKU 1392328 **34⁹⁹**
12701



White

SKU 1392312
12721

34⁹⁹



Customer Responsible For Offloading, Liftgate Service Available.

- Free Delivery in 48 Continental United States
- Specifications Subject to Change without Notice or Liability
- Equipment Lead Times and Shipping May Vary
- Customers Responsible for Offloading Equipment Upon Arrival
- Leasing Terms Available, Ask Your AutoZone® Commercial Sales Manager.

Prices subject to change without notice. Prices do not include applicable taxes, vehicles, tires, rims, installation or optional equipment as shown. Please do not return purchases to the store. For information regarding warranty, repair, or any questions or concerns, call 901-300-4878.

AZG0326

121

TOOL ORGANIZATION

2 Post Socket Trays

6 Piece Socket Tray Sets

- Metric Socket Range: 4 mm to 15 mm (1/4" Drive), 6 mm to 20 mm (3/8" Drive), 10 mm to 27 mm (1/2" Drive)
- SAE Socket Range: 1/8" to 5/8" (1/4" Drive), 1/4" to 1" (3/8" Drive), 3/8" to 1-1/4" (1/2" Drive)
- Includes: 6 Trays - 1/4", 3/8" and 1/2" Drive in Both Metric and SAE



Tools Not Included

Metric **Black and Green**
SKU 949573
22233
SAE **36⁹⁹**

Metric **Black and Orange**
SKU 1142583
22418
SAE **36⁹⁹**

Metric **Gray and Red**
SKU 477209
22413
SAE **36⁹⁹**

3 Piece Socket Trays

OEM TOOLS

- Includes: 3 Trays - 1/4", 3/8" and 1/2" Drive

SAE **Green**
SKU 749921
22207
30⁹⁹

Metric **Black**
SKU 749937
22211
30⁹⁹



Tools Not Included

Magnetic Socket Tray Sets

3 Piece Magnetic Socket Tray Set Metric or SAE

- Includes: 3 Trays - 1/4", 3/8" and 1/2" Drive in Metric or SAE

Blue (Metric) **Metric**
SKU 1149155
22486 **59⁹⁹**

Black (Metric) **Metric**
SKU 1149156
22487 **59⁹⁹**

Red (SAE) **SAE**
SKU 1149183
22484 **59⁹⁹**

Green (SAE) **SAE**
SKU 1149165
22485 **59⁹⁹**



OEM TOOLS



6 Piece Magnetic Socket Tray Set - Metric and SAE

- Includes: 6 Trays - 1/4", 3/8" and 1/2" Drive in Both Metric and SAE

Black and Green **Metric** **SAE**
SKU 1331490
22488 **89⁹⁹**

Blue and Green **Metric** **SAE**
SKU 1392463
22461 **89⁹⁹**

Black and Red **Metric** **SAE**
SKU 1485048
22460 **89⁹⁹**

Blue and Red **Metric** **SAE**
SKU 1331485
22489 **89⁹⁹**



- SAE**
- 1/4" Tray Holds 2 Sets of Sockets 1/8" to 5/8"
 - 3/8" Tray Holds 2 Sets of Sockets 3/8" to 7/8"
 - 1/2" Tray Holds 1 Set of Sockets 3/8" to 1-1/4"

- METRIC**
- 1/4" Tray Holds 2 Sets of Sockets 4 mm to 14 mm
 - 3/8" Tray Holds 2 Sets of Sockets 6 mm to 20 mm
 - 1/2" Tray Holds 1 Set of Sockets 10 mm to 27 mm

Tools Not Included

Pro Socket Organizer

OEM TOOLS

Magnetic Socket Tray

SKU 082922
22389 **44⁹⁹**

- Store Up to 36 Total Sockets - 1/4", 3/8" and 1/2" Drive
- Removable Back Panel Allows Magnets to Adhere to Any Magnetic Surface

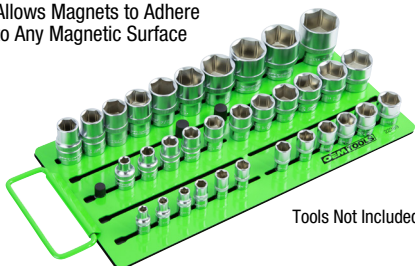

Tools Not Included

Magnetic Socket Organizers

OEM TOOLS

Portable Magnetic Socket Organizers

- Holds Up to 28 Sockets
- Powerful Magnets Hold Sockets Securely and Attach Organizer to Any Magnetic Surface
- Low-Profile Design Fits Most Toolbox Drawers



3/8" Drive
SKU 1442590
23117 **31⁹⁹**

1/2" Drive
SKU 1414403
23118 **34⁹⁹**



Tools Not Included

Tool Holder

OEM TOOLS

Magnetic Tool Holder

SKU 749848
22212 **34⁹⁹**

- 18" Rail with 16 Sliding Clips
- Multipurpose Clips Hold a Variety of Tools
- Great for Screwdrivers, Ratchets, Wrenches, Pliers and Other Small Tools
- Powerful Magnet for Secure Hold
- Foam Shield to Protect Paint Finishes



TOOL ORGANIZATION

TO ORDER, contact your Commercial Sales Manager or go to AutoZonePro.com

TOOL ORGANIZATION

Magnetic Trays

4 Piece Magnetic Foldable Tray

SKU 1207890 **33⁹⁹**
26052

- Collapsible Tray Expands from 3/4" to 2" Deep
- Holds Up to 2 Lb.
- Multiple Color Set Keeps You Organized
- Dimensions: 4-1/2" x 4-1/2"



Tools Not Included

Magnetic Trays

- Trays Stick to Most Metal Surfaces
- Ideal for Holding Small Parts and Tools
- Heavy Duty Stainless Steel

5" x 9"

SKU 965834 **14⁹⁹**
25117C

- 2 Powerful Magnets with Protective Rubber Coating to Resist Scratching



10" x 11"

SKU 965835 **30⁹⁹**
25119

- 4 Powerful Magnets with Protective Rubber Coating to Resist Scratching



Tools Not Included

Organizers

16 Piece Pliers Holder

SKU 765589 **20⁹⁹**
22215

- 16 Extra-Wide Spaces for Pliers with Rubber Grips
- Vinyl Coating for Lasting Dependability
- Dimensions: 14.0" (L) x 5.2" (W) x 2.5" (H)

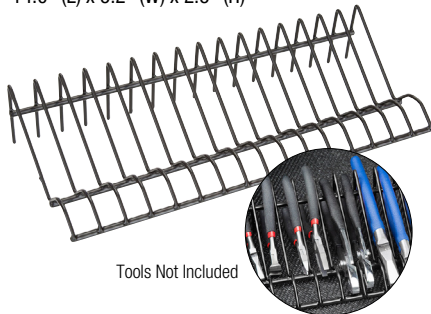

Tools Not Included

Drawer Organizer Tray

SKU 749932 **19⁹⁹**
22213

- Rolled Bottom Edges Allow Easy Removal of Small Parts
- Low-Profile Fits in Shallow Toolbox Drawers
- 10-Compartment Tray
- Stackable Design
- Dimensions: 16" (L) x 11" (W) x 1.5" (H)



Magnetic Bit Holders

4 Piece Magnetic Hex Bit Trays

SKU 1284964 **39⁹⁹**
24142

- Each Tray Holds 36 Hex Bits
- Coated Magnetic Trays Adhere to Most Metal Surfaces



Paper Towel Holder

Magnetic Paper Towel Holder

SKU 280376 **11⁹⁹**
24952

- Adjusts to Fit Different Size Rolls
- 3 Rubber-Faced Magnets Won't Scratch Metal Surfaces



Towel Roll Not Included

Wrench Organizers

4 Piece Magnetic Wrench Rails

- Holds 40 Wrenches
- Includes: 4 Rails
- Rail Dimensions: 16.6" (L) x 1.9" (H)

Green
SKU 749850
22217 **28⁹⁹**

Black
SKU 765514
22219 **28⁹⁹**



Tools Not Included

2 Piece Wrench Organizing Rails - Black

SKU 213161 **11⁹⁹**
22218

- Holds 35 Wrenches
- Slotted Design Will Fit a Variety of Wrench Types and Sizes
- Rail Dimensions: 23.4" (L) x 1.0" (H)

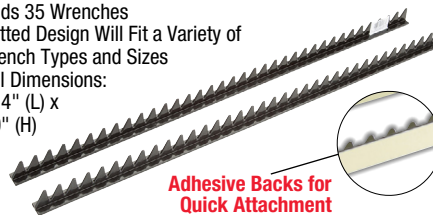

Adhesive Backs for Quick Attachment

Magnetic Wrench Organizer

SKU 662782 **19⁹⁹**
22177

- Organize Up to 12 Wrenches
- Strong Magnets Will Hold Organizer Upright at Full Capacity
- Non-Marring Foam Backing
- Durable Coated Steel Construction



Tools Not Included

Pro Magnetic Wrench Organizer (Black)

SKU 213098 **19⁹⁹**
22176

- Organize Up to 12 Wrenches
- Strong Magnets Will Hold Organizer Upright at Full Capacity
- Non-Marring Foam Backing
- Durable Coated Steel Construction



Magnetic Wrench Holder and Organizer

- Holds 10 SAE or Metric Wrenches
- Magnetic Base Attaches to Your Tool Box, Tool Chest, Cart or Metallic Peg Board
- Dimensions: 9-1/4" (L) x 1-1/4" (W) x 2" (D)

Green
SKU 1331491
22512 **16⁹⁹**



Black
SKU 1331501
22513 **16⁹⁹**



Tools Not Included

Prices subject to change without notice. Prices do not include applicable taxes, vehicles, tires, rims, installation or optional equipment as shown. Please do not return purchases to the store. For information regarding warranty, repair, or any questions or concerns, call 901-300-4878.

SHOP EQUIPMENT

Shop Presses

20 Ton Super Duty Air/Manual Shop Press

SKU 1544673 **1,299⁹⁹**
29000

- Fully Welded Construction and Powder-Coated Steel Frame for Unmatched Durability
- Movable Cylinder and 10 Height Adjustments with 4.3" Increments for Operator Versatility
- Glycerin-Filled Pressure Gauge Ensures Precise Pressure Readings Every Time
- Air/Hydraulic Pump Supports Both Manual and Pneumatic Operation (110-120 psi)
- Includes Anti-Slip Steel Blocks and Meets ASME PASE-2019 Standards

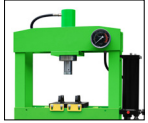

Adjustable Hydraulic Cylinder



Fully Welded Construction

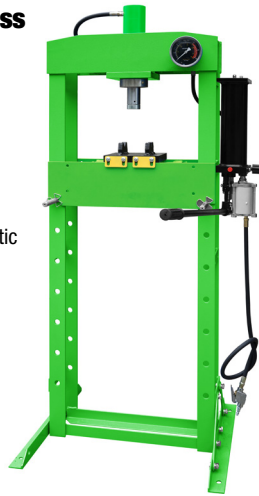

30 Ton Super Duty Air/Manual Shop Press

SKU 1525570 **1,674⁹⁹**
29001

- Fully Welded Construction for Exceptional Strength and Durability
- Movable Cylinder for Added Flexibility In Working Position
- Glycerin Filled Pressure Gauge for Accurate Pressure Readings
- Polycarbonate Protective Guard Shield for Maximum Safety Against Shrapnel and Debris
- Air/Hydraulic Pump Supports Both Manual and Pneumatic Operation (110 to 120 psi)
- Includes Anti-Slip Steel Blocks and Meets ASME PASE-2019 Standards

Polycarbonate Protective Guard Shield for Maximum Safety Against Shrapnel and Debris

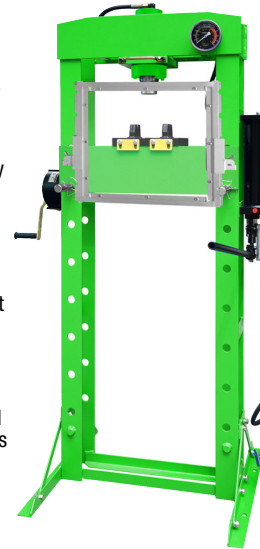

OEM TOOLS®

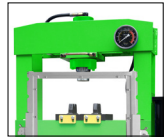

Adjustable Hydraulic Cylinder



Glycerin Filled Pressure Gauge

20 Ton Air Hydraulic Shop Press

SKU 662928 **999⁹⁹**
25087

- Removable Press Cap with 25 mm Hole to Accept OEMTOOLS Press Pin Set (#24813)
- Air/Hydraulic Pump Provides Added Versatility
- Double Speed Pump Greatly Reduces Set-Up and Press Time
- Movable Press Head for Flexibility of Working Positions
- Liquid Filled Pressure Gauge for Accurate Pressure Readings
- Durable Powder Coated Steel Frame
- Includes Press Blocks



Liquid Filled Dual Scale Gauge

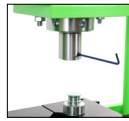

Removable Press Cap with 25 mm Hole



10 Ton Hydraulic Bench Top Shop Press

SKU 666327 **499⁹⁹** REG. \$599.99
25088

- Removable Press Cap with 25 mm Hole to Accept OEMTOOLS Press Pin Set (#24813)
- Double Speed Pump Greatly Reduces Set-Up and Press Time
- Movable Press Head for Added Flexibility in Working Position
- Liquid Filled Pressure Gauge



Press Blocks Included

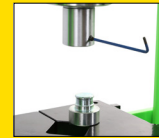

Removable Press Cap



SAVE \$100

Offer Good Through September 30, 2026

Press Accessories

8 Piece Press Accessory Kit

SKU 1525566 **199⁹⁹**
29002

- Includes: 2 Press Plates, 5 Punches and a Bearing Shield
- Sizes 1/2", 3/4", 1", 1-1/2" and 2"
- Capacity: Up to 50 Tons

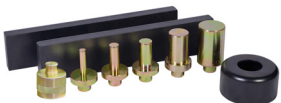

30 Ton X Style Press Plates

SKU 1544680 **99⁹⁹**
24808

- For Use on All Presses Up to 30-Ton Capacity
- "X" Type Design for Use in Many Different Pressing Operations
- 1.2" Steel Thickness to Comply with ASME PASE Requirements



Shop Press Pin Set

SKU 544794 **149⁹⁹**
24813

- Includes: Set of 8 Press Pins (2-20 Ton Capacity), 25 mm Quick Change Adapter Chuck and Mountable Bracket
- Suitable for Use with Hydraulic Ram Style Shop Presses That Have a Female Ram Assembly Diameter of 25 mm and are Secured with a Bolt
- Works with OEMTOOLS 24811, 24812, 25087 and 25088
- Not for Use with Bottle Jack Style Shop Presses



Universal Press Support

SKU 804487 **249⁹⁹**
24809

- Will Make Your Shop Press Safe and Easy to Use
- Supports in 3 Points to Ensure Safe Support without Any Wobbling
- Numerous Holes on Main Block and Swivel Element for Easy Set-Up
- Swivel Element and Removable/Height Adjustable Anvil Bolts Allow Adjustment to Individual Requirements
- Dimensions: 7-3/4" (W) x 9-3/4" (L) x 1-1/2" (H)

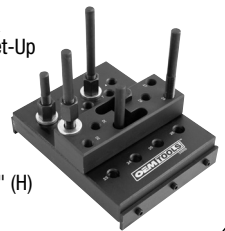

Bearing Separators

5 Ton Bar-Type Puller/Bearing Separator Set

SKU 347218 **93⁹⁹**
27236

- Separator Tools are Used with Bar Puller and Legs for a Wide Variety of Pulling Jobs
- Set Includes: 2" and 3" Bearing Splitters, 4 Sets of Hex Push-Puller Legs and a Bar-Type Puller Head with a 9/16" Forcing Screw

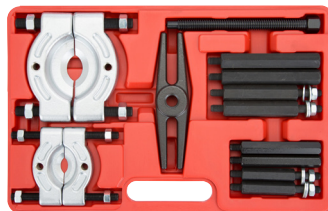

Bearing Splitter 1/4" to 15/16"

SKU 514005 **28⁹⁹**
27231

- Maximum Spread: 15/16"
- Minimum Spread: 1/4"
- Thread of Tapped Holes in Adapter: 5/16" to 18"
- Distance Between Adjusting Screws: 1-11/16"



Bearing Splitter 1/2" to 4-5/8"

SKU 514006 **79⁹⁹**
27232

Bearing Splitter 1/8" to 2"

SKU 516522 **28⁹⁹**
27084

OEM TOOLS®

Aqueous Parts Washers

- Works with Safe Water-Based Cleaning Solutions Only (Not for Use with Solvents)
- 325 GPH Pump
- Powder-Coated 20 Gauge Steel for Durability and Rust Resistance



Steel Parts Washers

3.5 Gallon Bench Top

SKU 300128 24800 **99⁹⁹**

- Dimensions: 18" (L) x 13-1/2" (W) x 9" (H)



20 Gallon Mobile

SKU 750449 24805 **329⁹⁹**

- 4" Casters for Maneuverability
- Drain Tray with 2.9 Gallon Collection Reservoir
- Dimensions: 38" (L) x 21.5" (W) x 37" (H)



20 Gallon

SKU 300117 24801 **299⁹⁹**

- Small Parts Tray
- Dimensions: 31" (L) x 21" (W) x 34.5" (H)



40 Gallon

SKU 300118 24803 **449⁹⁹**

- Small Parts Tray
- Dimensions: 44.75" (L) x 20.5" (W) x 35" (H)



Pneumatic Heated Parts Washer Cabinet

SKU 1330681 24677 **899⁹⁹**

- Compressed-Air Spray with Heated Cleaner for Maximum Cleaning Power
- Fully Enclosed Cabinet Keeps Solution and Debris Contained
- Thermostat-Controlled Heat Up to 140°F (60°C)
- Interior Light and Vent Fan for Better Visibility
- Built-In Regulator and Pressure Gauge
- Adjustable Leveling Pads for Uneven Floors
- 3.5-Gallon Solution Capacity



4 Gallon Mobile Parts Washer

SKU 546660 24804 **149⁹⁹**

- Lid Has Positive Seal and Latches for Mobility
- 4 GPM Pump
- Dimensions: 26" (L) x 18" (W) x 9.5" (H)



Portable Bucket-Top Parts Washer

SKU 003759 24816 **69⁹⁹**

- Fits Most Standard 5 Gallon Buckets
- Includes: Submersible Pump, 40" Hose and Flow-Through Brush
- Pumping Rate: 1 GPM



Aqueous Solutions

Blue Liquid Aqueous Concentrate

SKU 1485035 SRIPFOL2P-100 **159⁹⁹**

- Designed for industrial Cleaning
- Concentrated Cleaning Solution for Biological Parts Cleaning
- Water Based
- ECO friendly



Innovates in maintenance products.

Heavy Duty Degreaser Concentrate (5 Gallons)

SKU 227558 WWSHD-5G **279⁹⁹**

- Quickly Removes Grease, Oil, Carbon and Grime While Safe for the Technician



Designed to Effectively Replace Hazardous Solvent in Water-Based Parts Washers

Washer Accessories



Straight Handle Flow Thru Parts Washer Brush

SKU 1368637 BRMPWA **42⁹⁹**

- Made with Synthetic Filaments to Resist Solvent Cleaners
- Works with Most Popular Recirculating Parts Washers
- For Use in Either Petroleum-Based or Water Based Solutions



Parts Washer Brush without Tube

SKU 1368624 BRMPWANT **28⁹⁹**



Air Operated Sprayer

SKU 222507 LIN5983 **89⁹⁹**

- 1/4" NPT (F) Inlet
- Max. Operating Pressure: 150 psi
- Can Be Used with Solvents or Detergent Solutions



Shop Vacuum



Air Blow and Suction Gun

SKU 1168663 26038 **59⁹⁹**

- One-Touch Button That Changes the Gun from Blow to Suction
- Standard Shop Vacuum Power for Quick and Easy Clean Up
- Lightweight Gun
- High Filtration Collection Bag
- Rugged and Durable Metal Construction and Easy-to-Use Trigger
- 1/4" PT/NPT Inlet and 90 psi



SHOP EQUIPMENT

Floor Scrubbers

Battery Powered 14" Floor Scrubber

SKU OSB
IPCCT15
5,199⁹⁹

- Height-Adjustable Handle
- Removable Recovery Tank
- 1.5 Hour Run Time
- Includes: Lithium Battery, Charger and Brush



WARRANTY:
10 Years Tank
3 Years Parts
3 Years Battery

Battery Powered 20" Floor Scrubber

SKU OSB
IPCCT50
5,359⁹⁹

- 13 Gallon Tank Capacity
- 2.5 Hour Run Time
- For Up to 10 Bay Shop
- Includes: Self-Leveling Brush Head and Cast Aluminum Squeegee Assembly, 2 AGM Maintenance Free Batteries and Charger



WARRANTY:
10 Years Tank, 3 Years Parts, 1 Year Battery

Cleaner/Degreaser 1 Quart Bottle (6 Pack)

SKU OSB
IPCT80451 **172⁹⁹**

- High Performance Concentrated Formula Quickly Cuts through Grease, Oil and Tough Carbon Soils



For OSB, Call 901-300-4878

Abrasive Blasting



Bench Top Abrasive Blast Cabinet

SKU 300119
24815 **299⁹⁹**

- Easily Remove Paint, Rust and Oxidation
- Fits on the End of Any Bench or Cabinet
- Overall Height: 19.3"
- Exterior Width: 19.3"
- Work Area: 3.18 Cubic Ft.
- Includes: 10 Replaceable Window Underlays



25 Lb. Glass Bead Blasting Media

- Ideal for Many Uses
- Removes Surface Rust
- Paint and Body Applications

Coarse
SKU 010136
SHA13077
189⁹⁹

Medium
SKU 010139
SHA13078
189⁹⁹



Spray Wash Cabinets

- Heavy Duty Steel Construction
- Removable Parts Tree
- Brass Nozzles
- Heavy Duty Rubber Casters
- Stainless Oil Skimmer
- Removable Tank Screen

Each Cabinet Includes:
20 Lb. Aluma-Klean Soap Bucket
RAN5155096

VALUE:
\$152.99



Inside Height 43"

SKU	Part #	Product	Tank Capacity	Load Capacity	Price
1105323	RANRS500DS	Stainless Steel	50 Gallon	500 Lb. Load	14,899.99
1089035	RANRS750DS	Stainless Steel Truck	53 Gallon	1,000 Lb. Load	15,899.99
82919	RANRS500D	Professional	50 Gallon	500 Lb. Load	9,169.99
82920	RANRS750D	Truck	53 Gallon	1,000 Lb. Load	9,919.99

Aluma-Klean Soap Bucket

20 Lb.
SKU 751966
RAN5155096 **152⁹⁹**

50 Lb.
SKU 1442593
RAN5155100 **349⁹⁹**



Customer Responsible for Offloading, Liftgate Service Available.

CRC SmartWasher[®] BIOREMEDIATING parts washing system

A SMARTER & SAFER SOLUTION

The CRC SmartWasher[®] is a manual parts washer that replaces traditional solvent or aqueous alternatives.

- Bioremediation Technology
- Powerful Cleaning Performance
- No Hazardous Waste Generation
- Lower Operating Cost

Product	Part #	Price
SmartWasher SW-723 Kit*	14743	\$2701.99
OzzyJuice [®] SW-7	14721	\$167.99
OzzyMat [®] FL-4	14124	\$36.99

Check out our YouTube channel here



crcindustries.com/smartwasher

*1 SW-23 SmartWasher[®] Unit, 3 5-Gallon jugs of OzzyJuice[®] SW-7 Parts/Brake Cleaning Solution, and 1 FL-4 OzzyMat[®] Multi-Layer Fluid Activation Mat

Pipe Bender

BB-2 Pipe Bender with 302 Die Package

SKU 15341 **11,339⁹⁹**
BENBB2

- Knee Control and Depth-of-Bend Degree Plate for Manual Bending Operations
- Includes: BB-2 Tooling Package, Quick Release Bending and Finishing Dies, High-Speed Clampless Swager and Internal Expander

1302 Automatic with 302 Die Package

SKU 15346
BEN1302BAS302

12,189⁹⁹



Large 3" Die Package – Optional

SKU 95070 **1,699⁹⁹**
BEN300-1

- Optional Die Package Extends the Bending Capabilities of Your BendPak Pipe Bender

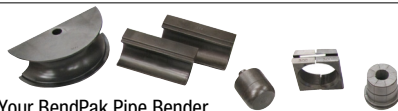

BendPak

Drill Press

15" 16 Speed Floor Drill Press

SKU 082857
24992

699⁹⁹

- Drilling Depth: 3-5/16"
- 16 Speed Spindle: 240 to 3,200 RPM
- Dimensions: 15" x 25-1/3" x 63-1/3"
- Distance from Spindle to Table: 27"
- Distance from Spindle to Base: 47"



Chuck Size:
5/8" JT3 Taper

Swings:
15"

OEM TOOLS

To Confirm Price, Availability and Ordering Instructions on OSB, Call 901-300-4878

Hot Water Pressure Washers

HSE 1400 psi Hot Water Pressure Washer

SKU OSB
MTMHSE1400M11 **3,329⁹⁹**

- Diesel or Kerosene Fired Burner
- 1400 psi, 2.0 GPM
- 1.5 HP, 120V
- Includes: 50' x 3/8" Wire Braided Hose, Adjustable Pressure Insulated Dual Lance with 15° Fixed and Detergent Nozzle



HSE 1500 psi Hot Water Pressure Washer

SKU 597218 **4,229⁹⁹**
MTMHSE15020MM

- Diesel or Kerosene Fired Burner
- Fuel Consumption: 1.2gph
- 1500 psi, 2.0 GPM
- Temperature Rise: 150°F (66°C); Max. Outlet Temperature: 200°F (93°C)
- Includes: Quick Connect Nozzles - 0°, 15°, 25° and 40°, 50' x 3/8" Wire Braided Hose and Adjustable Pressure Insulated Dual Lance



Mi-T-M

Dual Fuel Powered Generator

CHAMPION

5500-Watt Dual Fuel Portable Generator

SKU OSB
CHM201505 **849⁹⁹**

- Dual Fuel: Runs on Gasoline or Propane, Providing Up to 11 Hours of Run Time on Gasoline or 6.5 Hours on Propane
- Monitors Voltage, Frequency and Run-Time Hours



Vises

4" Heavy Duty Bench Vise with Swivel Base

SKU 751643 **74⁹⁹**
24217

- Polished Replaceable Steel Jaws
- Polished Anvil
- Permanent Pipe Jaws
- Full 360° Swivel Base
- Clamping Strength: 200 Lb.



OEM TOOLS

6" Heavy Duty Bench Vise with Swivel Base

SKU 751654 **159⁹⁹**
24218

- Replaceable Steel Jaws
- Permanent Pipe Jaws
- Full 360° Swivel Base
- Jaw Width: 6"
- Jaw Opening: 6"
- Throat Depth: 2.6"



OEM TOOLS

6-1/2" Professional Workshop Vise

SKU 394648
KTL64065

- Jaw Width: 6-1/2"
- Jaw Opening: 9" Replaceable, Reversible Jaws



Ken-Tool
WHEREVER TIRES ARE CHANGED

SHOP EQUIPMENT

Nitrous Key Program

Pay It Off In 3 Months with Just 2 Keys/Day
Add \$78,000 in Annual Revenue*



AutoProPAD G3 Evo with Complete Key Making System

SKU OSB
NIT20402085

Includes Starter Inventory — Coverage for the Most Popular Remotes/Remote Keys/Smart Keys

- Complete Key System: Triton PLUS Auto Edition, AutoProPAD G3 Evolution, Remotes and Transponder Keys
- Fast Key/Remote Lookup by Year/Make/Model on NitrousKeys.com
- Triton PLUS: Decode, Duplicate and Cut Most High-Security Auto/Motorcycle Keys
- AutoProPAD G3: Key Programming for Common and Advanced Jobs
- 100+ Remotes/Remote Keys/Smart Keys for Popular Vehicle Makes
- Build-A-Key Components to Make Hundreds of Keys
- U.S.-Based Tech Support and Free Weekly Training



9,199⁹⁹

REG. \$10,629.96

SAVE OVER \$1,429

When You Buy the Kit

Triton PLUS Key Machine Automotive Edition

SKU OSB
NIT20201002 **4,499⁹⁹**

- Built For Auto: Cuts 99% Of Contemporary Automotive Keys
- Includes Automotive + Tibbe Jaws: TRJ1 and TRJ4
- Includes Dimple Cutters: Standard "C", MTL Inside "D", MTL Outside "E"
- Includes VW Cutter: 1.5 mm for HU162T and HU198T
- Duplicate Cut Keys by Code
- Fleets: Save Key Profiles in Memory, Easily Cut Lost Keys
- Engrave with Optional Jaw



Triton PLUS Key Machine Ultimate Edition

SKU OSB
NIT20201010 **6,449⁹⁹**

- All-In-One: Automotive, Commercial, Residential Plus Engraving
- Includes All Jaws: TRJ1, TRJ2, TRJ3, TRJ4, TRJ5, TRJ6
- Adds Flip-Blade Creation Jaw for Xhorse/KeyDIY Blades
- Extra Consumables: Multiple Cutters/Decoders (Including VW 1.5 mm)
- Includes Mounting Brackets + 12V Car Power Adapter



To Confirm Price, Availability and Ordering Instructions on OSB, Call 901-300-4878 | *Average 2 keys per day. Average charge for example is \$150.

SHOP OWNERS, WE LOAN SPECIALTY TOOLS FOR SPECIAL JOBS!

AUTOZONE® LOAN-A-TOOL® PROGRAM

Over 90 Specialty Tools for Loan or Sale

We offer the most complete selection of tools for a variety of jobs, from steering and suspension, air conditioning, engine repair and more.

The best part is Loan-A-Tool® products are free to use! Leave a deposit at the store when you pick up the tool. When you're through just bring it back within 90 days, and we'll refund the deposit, or keep the tool.

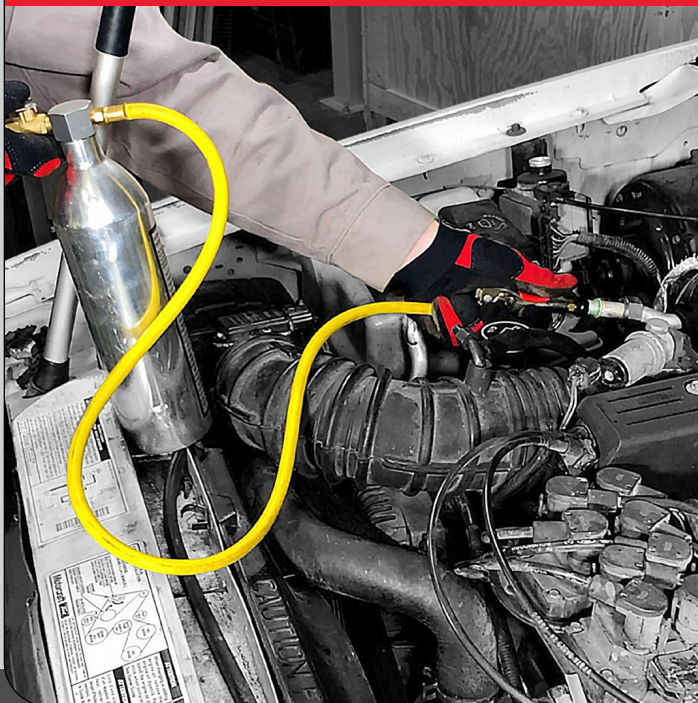

Ford Triton Spark Plug Porcelain Extractor Master Set



A/C Flush Kit



Fuel Injector Puller Kit - VW/Audi

See your Commercial Sales Manager for a complete list of loaner tools.

Repair System

Glue Pull Repair System

SKU OSB
HSAGPR-7571 **799⁹⁹**

- Includes: 29 Knobs and Tabs, 1/2" to 5"
- Glue Sticks with Knockdown and Scraper Tool

NEW

For OSB, Call 901-300-4878



H&S
AUTOSHOT

Pulling Tower

Pull-PRO Portable Dent Pulling Tower

SKU OSB
HSAUNI-1096 **1,399⁹⁹**

- 1,300 Lb. of Pulling Force
- Extended Non-Scratching Pull Straps
- Air Pressure Requirements: 87-116 psi, 6-8 CFM

For OSB, Call 901-300-4878

NEW



H&S
AUTOSHOT

Air Suction Plate Grips to Any Shop Floor

Body Repair

Fast Action Body Repair Kit

- Includes: Hydraulic Pump, Hydraulic Ram, 4 Extension Rods, a Rubber Ball Foot and a Duckbill Hydraulic Spreader
- Features a Faster Double-Action Hydraulic Pump
- Includes: Blow Mold Case

4 Ton
SKU 301327 **279⁹⁹**
24820

10 Ton
SKU 301328 **329⁹⁹**
24821



OEM TOOLS

3 Piece Body Seam Splitter Set

SKU 265129 **49⁹⁹**
25337

- Includes: Straight, 30° Offset and 90° Angle Seam Splitters
- Tough Chrome Vanadium Steel
- GoThru® Shafts
- Shock Dampening Grip Provides Comfort



Door Tools

Door Spring Tool

SKU 447118 **11⁹⁹**
25336

- Quickly and Easily Remove or Install Door Hinge Springs
- Designed for GM Cars and Light Trucks



OEM TOOLS

Panel and Trim Clip Pliers

SKU 447154 **27⁹⁹**
25930

- Designed to Remove Panel Clips
- Constructed with a Durable Chrome Plated Alloy Steel
- 2-Step Tip Minimizes Risk of Clip Damage
- Ergonomic Comfort Grip Handles for Reduced User Fatigue



Double Ended Clip Lifter

SKU OSB **16⁹⁹**
25308

- Lifts Center Pins and Releases Push-Pin Retainers for Faster Removal
- Ideal for Door Panels, Upholstery Retainers and Interior Trim Service
- Works Great on Splash Shields, Wheel Well Liners and Underbody Panel Clips
- Thin Tips Slip Under Tight Clips to Help Reduce Scratches and Broken Fasteners



For OSB, Call 901-300-4878

Hood Props

OEM TOOLS

Telescopic Hood Support

SKU 420337 **17⁹⁹**
24211

- Simple Turn Locks and Unlocks the Support in Place
- Rubber End Caps Protect Vehicle's Finish
- 21" When Closed and Almost 48" When Fully Extended
- Compact and Easy to Store, Easy to Use



48" REACH

Hood Prop with Adapter

SKU 291352 **84⁹⁹**
LIS46170

- Includes a Support to Help Prevent Slipping
- 3 Piece Telescoping Shaft Locks in Any Position (Telescopes from 20" to 48-1/4")



Lisle

Universal Lift Support Clamp

SKU 191671 **14⁹⁹**
25307

- Aluminum Body and Brass Threads Prevent Damage to the Lift Support
- Red Color Serves as a Reminder to Remove the Clamp Before Closing

OEM TOOLS



5 Piece Door Panel and Trim Remover Set

SKU 989263 **69⁹⁹**
25312

- Comprised of 3 Door Panels and 2 Trim Tools
- Textured, Comfortable Grips with Thumb Stop and Hanging Hole



6 Piece Door Panel and Trim Removal Set

SKU 003868 **44⁹⁹**
25301

- Includes: V-Notch Clip Remover, U-Notch Clip Remover, 2 Door Panel Removal Tools, C-Type Clip Removal Tool and Handle Clip Removal Tool



Dent Puller

OEM TOOLS

Slide Hammer Dent Puller Set

SKU 265148 **174⁹⁹**
25922

- 12 Lb. Hammer, Slide Hammer Shaft, Slide Hammer Handle, Slide Hammer Adapter, Deep Hook, Short Hook, Door Edge Tool, Claw, Straight Driver, Hook and Chain, Sheet Metal Screw and Holder, Nose Piece with Screw
- Comes in a Blow Mold Case

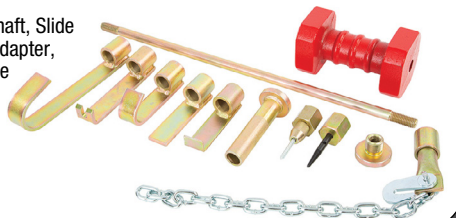

Trim Tools

Air Bag Release Tool for GM

SKU 191678 **14⁹⁹**
25310

- Fits Most GM Cars, Minivans and Light Trucks
- Tips are Tapered to Make Removal Easier



Trim Fastener and Molding Remover Set

SKU 900801 **12⁹⁹**
25314

- Includes: 5 Tools for Easy Removal of Fasteners, Molding, Wheel Hubs and More
- For Use on Internal and External Vehicle Molding and Trim Fasteners



OEM TOOLS

WELDING & CUTTING

Multi-Process

HSM140 Multi-Process Welder (115V, 140A)

SKU OSB
HSAHSW-6215 **1,199⁹⁹**

- Multi-Process Welding Capability – Supports MIG, Flux-Cored, Lift-TIG and Stick Welding
- Output Power and Duty Cycle – 35–140 Amp Range @ 115V with 140A @ 35% Duty Cycle
- Synergic MIG Technology – Automatically Adjusts Voltage and Wire Feed for Consistent Weld Quality
- Material Versatility – Welds Steel, Stainless Steel and Aluminum (Spool Gun Required)
- Includes: MIG Gun, Work Clamp, Gas Regulator and Starter Welding Wire
- Accessory-Ready System – TIG Torch, Stick Electrode Holder and Spool Gun Sold Separately



MIG Welder

MIG and Flux-Core Welder (130 Amp)

SKU OSB
HSAHSW-6213 **889⁹⁹**

- Features Wire Speed and Power Settings by Material/Wire Thickness
- Rated Duty Cycle: 20% @ 130 Amps
- Includes: Inverter, Power Supply, Torch, Earth Clamp, Gas Regulator, Spool of .030" FluxCore Wire and Spool of .030" MIG Wire



HSM200PRO MultiMIG Welder (Dual Voltage, 200A, AC/DC TIG)

SKU OSB
HSAHSW-6422 **3,799⁹⁹**

- Multi-Process Welding Capability – Supports MIG, Flux-Cored, Stick and AC/DC Aluminum TIG Welding
- Output Power and Duty Cycle – Up to 200 Amp Output with 200A @ 35% Duty Cycle; Dual Voltage Input (115V or 230V)
- Synergic MIG Technology – Pre-Set Programs with Adjustable Voltage and Wire Feed
- Digital Controls – Large LCD Display with Advanced Parameter Adjustments
- Includes: MIG Gun, TIG Torch with Foot Pedal, Electrode Holder, Work Clamp, Gas Regulator and Starter Consumables



AC/DC TIG Capability – Welds Aluminum (AC) and Steel/Stainless (DC) with Advanced Control

200A Multi MIG Synergic, TIG & Stick Welder (115-230VAC)

SKU OSB
HSAHSW-6420 **2,649⁹⁹**

- Welds MIG, DG TIG and Stick up to 3/8" Mild Steel
- 115V or 230V
- Inverter Rated 200A @ 35% DC
- 16 Program LCD Synergic Input
- Includes: Welder, MIG Gun, TIG Torch, Stick Cable, Earth Clamp Cable, Foot Pedal, 115V Adapter, Gas Regulator, Wire and TIG Kit
- Aluminum Spool Gun Ready (Not Included)



Plasma Cutter

40A Plasma Cutter (115-230VAC)

SKU OSB
HSAHSW-6004 **1,399⁹⁹**

- Genuine Cut 1/2" and Severance Cut 1" Mild Steel 115V or 230V
- High-Powered Inverter CSA/UL Rated 40A @ 50% DC
- LCD Display Output Power, Air Pressure, Grid or Standard Cut
- Includes: Plasma with Regulator-Filter, 48 Gun, Earth Clamp Cable, 115V Adapter and Spare Contact Drag Tips and Electrodes



Welding Accessories

Professional MIG/Stick Welding Gloves

SKU OSB
HSAHSW-9006 **13⁹⁹**

- Comfort Lined Welding Glove for Added Heat Protection
- Kevlar-Stitched for Extra Durability
- Made in Select Cow Split Leather
- Used for High Dexterity, Protection and Durability
- Glove Length: 14"



Welder's Combo Pack

SKU 459159
SHA14526 **54⁹⁹**

- Includes: Premium Kevlar Lined Gloves, Soft Corduroy Skull Cap and Lighter



To Confirm Price, Availability and Ordering Instructions on OSB Call 901-300-4878

Soldering

Mechanics Butane Mini Torch

SKU 804655 **24⁹⁹**
24353

- Adjustable Flame Lights Upside Down
- Auto Ignition, Refillable
- Safety Lock When Not in Use

Butane Not Included



Mechanics Butane Torch

SKU 802236 **34⁹⁹**
24354

- Heavy Duty Piezo Ignition with
- Strong Flame

Butane Not Included



Professional 3-in-1 Butane Soldering Iron Kit

SKU 420338 **54⁹⁹**
24355

- Includes: Soldering Iron, Metal Tip Wicking Cup with Sponge, Solder Wire, Protective Tip Cap, Heat-Shrink Deflector, Chisel Point Tip, Anvil Solder Tip, Needle Tip and Hot Air/Soldering Tip
- Cable Free



OEM TOOLS

Professional 3-in-1 Butane Micro Torch Kit

SKU 420339 **43⁹⁹**
24356

- 3-in-1 Design Can Be Used as a Soldering Iron, Torch or Hot Air Blower without Iron Tip
- Micro Torch Kit Includes: Torch, Metal Tip Wicking Cup with Sponge, Heat-Shrink Deflector, Chisel Point Tip, Anvil Solder Tip, Needle Tip and Hot Air/Soldering Tip and Base
- Ideal for Use with Electrical Repair, Tin and Plastic Melting, Heat-Shrinkable Tubing, Auto Repair, Hobby Repair and Jewelry Repair
- Power Range: 30W to 125W



Butane Not Included

Professional Soldering Gun Kit

SKU 1362003 **79⁹⁹**
24773

- Includes: Heavy Duty 230/150-Watt Soldering Gun, General Purpose Soldering Tip, Plastic Cutting Tip and 0.5 Oz. (14 g) Rosin Core Solder
- Reaches Max. Temperature of 937°F at Low Power
- Reaches Max. Temperature of 1400°F at High Power
- 120V, 150/230W, 60 Hz



Welding Helmets

Valor Auto-Darkening Welding Helmet

SKU 1544661 **119⁹⁹**
FRN55861

- 5.97 Sq. In. (3.62" x 1.65") Viewing Area
- 2 Optical Arc Sensors
- 1/1/1/2 Optical Clarity Rating
- UV/IR Coating to Reduce Scratching and Discoloration of the Lens
- DIN 9 to 13 Variable Shade Selection
- 1/25,000 Per Second Switching Speed



Auto-Darkening Welding Helmet

SKU 362974 **89⁹⁹**
24357

- TIG Rated Variable Shade 9 to 13
- Viewing Area: 3.54" x 1.37"
- Battery Powered with Solar Assist
- Includes: Replacement Cover Lenses



Auto-Darkening Welding Helmet with Grinding Function

SKU 347233 **99⁹⁹**
24358

- TIG Rated Variable Shade 9-13
- Variable Sensitivity and Delay Controls
- 2 Independent Arc Sensors
- Grinding Function
- Lens Darkening is 1/25,000
- Battery Powered with Solar Assist
- Includes: Replacement Cover Lenses
- Viewing Area: 3.62" x 1.65"



Welding Cart

Welding Cart with Cylinder Support

SKU OSB **249⁹⁹**
HSAHSW-7000

- Heavy-Duty Cart with Extended Shelf for Inverter Machines
- 150 Lb. Capacity, Steel Hub Wheels with Bearings
- Works with Plasma Cutters: HSW-6213, HSW-6215, HSW-6222, HSW-6420, HSW-6422

For OSB,
Call 901-300-4878



H&S AUTOSHOT

Acetylene Torch

Medium Duty Torch Kit

SKU 1580955 **384⁹⁹**
FRN1705

- Cuts Up to 150 mm (5.91") and Welds Up to 9 mm (0.35") with Proper Tips
- Includes: 250-Series Regulators, 100-Series Torch Handle, 1350-Series Cutting Attachment, 0-3-101 Cutting Tip, W-1-0 Welding Tip, 1/4" (6.35 mm) X 12.5' (3.81 m) Twin Welding Hose with Fittings, #5 Goggles, Round Single Flint Striker, 13-Piece Tip Cleaner and Plastic Carry Case



Forney

Consumables

MIG Solid Wire .030 11 Lb. E70S6

SKU 459164 **64⁹⁹**
SHA12003

- Shielding Gas Required



MIG Wire .035 2 Lb. Flux Core E71T-GS

SKU 459180 **36⁹⁹**
SHA12009

- Used without Gas as a Shielding Agent on Mig Welders with Reverse Polarity



MIG Wire .030 2 Lb. Flux Core E71T-GS

SKU 459175 **44⁹⁹**
SHA12008

- Used without Gas as a Shielding Agent on Mig Welders with Reverse Polarity



SHARK USA

HAND TOOLS

Combo Wrench Sets

RingStop® Reversible Ratcheting Wrench Set

- Patented RingStop® Design Makes One-Hand Use Easy
- Posi-Grip No-Slip® Design
- Jaw is 15° Offset
- Made with Chrome Vanadium Steel



Flex Head Flare Nut Wrench Sets 5 Piece (SAE)



SKU 749849 **119⁹⁹**
22063

- 1/4" x 5/16", 3/8" x 7/16", 1/2" x 9/16", 5/8" x 11/16", 3/4" x 7/8"



6 Piece (Metric)

SKU 749930
22064

- 9 mm x 11 mm, 10 mm x 12 mm, 13 mm x 14 mm, 15 mm x 17 mm, 16 mm x 18 mm, 19 mm x 21 mm

10" Width x 7.8" Depth

8 Piece Set (SAE)

SKU 803139
23989 **129⁹⁹**

- SAE Sizes: 5/16", 3/8", 7/16", 1/2", 9/16", 5/8", 11/16" and 3/4"



10" Width x 7.8" Depth

12 Piece Set (Metric)

SKU 803140
23988 **189⁹⁹**

- Metric Sizes: 8, 9, 10, 11, 12, 13, 14, 15, 16, 17, 18 and 19 mm



15" Width x 10" Depth

BONUS VALUE: \$56.99

8 Piece Go Thru Socket Set (SAE)

22979



With Purchase of 23989

Offer Good While Supplies Last Through September 30, 2026

BONUS VALUE: \$69.99

12 Piece Go Thru Socket Set (Metric)

22978



With Purchase of 23988

Combo Wrench Sets

14 Piece (SAE)

SKU 802222 **244⁹⁹**
23993

- 1/4", 5/16", 3/8", 7/16", 1/2", 9/16", 5/8", 11/16", 3/4", 7/8", 15/16", 1", 1-1/16" and 1-1/8"

16 Piece (Metric)

SKU 802224 **199⁹⁹**
23994

- 6, 7, 8, 9, 10, 11, 12, 13, 14, 15, 16, 17, 18, 19, 21 and 22 mm



10 Piece Combination Wrench Set (Metric)

SKU 127920 **59⁹⁹**
22995

- Includes: 10 to 19 mm
- Posi-Grip No-Slip® Design Provides Off-Corner Loading for Greater Torque with More Socket-to-Fastener Contact
- Marked on All 4 Sides for Easy Identification

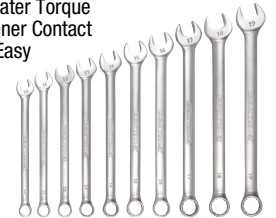

JUMBO WRENCHES

Jumbo wrenches are made of high quality drop forged steel and are precision machined to prevent fastener damage.

Additional Individual Jumbo Wrenches Available on AZTOOL1.COM



Sets Include Roll-Up Storage Bag

SKU	Part #	Metric or SAE	Size	Price
338830	22100	SAE	1-1/16", 1-1/8", 1-1/4", 1-5/16", 1-3/8" and 1-7/16"	99.99
338833	22101	SAE	1-1/2", 1-5/8", 1-3/4", 1-7/8" and 2"	149.99
338852	22120	Metric	21 mm, 22 mm, 24 mm, 25 mm, 27 mm, 29 mm, 30 mm and 32 mm	99.99
338858	22121	Metric	33 mm, 34 mm, 35 mm, 36 mm, 40 mm, 42 mm, 46 mm, 50 mm	169.99

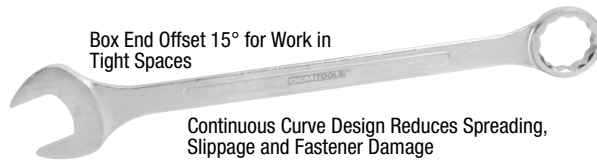

Box End Offset 15° for Work in Tight Spaces

Continuous Curve Design Reduces Spreading, Slippage and Fastener Damage

SKU	Part #	SAE Size	Price
338859	22102	1-1/16"	14.99
338864	22103	1-1/8"	19.99
338866	22104	1-1/4"	22.99
338868	22105	1-5/16"	19.99
338877	22106	1-3/8"	21.99
338890	22107	1-7/16"	19.99
338896	22108	1-1/2"	21.99
338898	22109	1-5/8"	29.99
338903	22110	1-3/4"	39.99
338935	22111	1-7/8"	46.99



Jumbo Angle Wrench Set



6 Piece Jumbo Angle Head Wrench Set

SKU 912341 **139⁹⁹**
22113

- Sizes: 1-3/8", 1-1/2", 1-5/8", 1-3/4", 1-7/8" and 2"



Includes Roll-Up Storage Bag



Ratcheting Combination Wrenches



16 Piece 12 Pt. Ratcheting Combination Wrench Set (Metric)

SKU 213125 **209⁹⁹**
KDT9416

- Includes: 8, 9, 10, 11, 12, 13, 14, 15, 16, 17, 18, 19, 20, 21, 22 and 24 mm
- Ratcheting Box End Requires Only 5° to Move Fasteners
- 12 Point Design Providing More Positions to Engage the Fastener



Wrench Extender

Wrench Extender

SKU 1368628 **40⁹⁹**
22656

- Safely Provides Extra Leverage to Loosen Rusted Bolts, Jammed Fasteners or Over-Tightened Nuts
- Great for Use on Hard-to-Reach Fasteners



HAND TOOLS

TO ORDER, contact your Commercial Sales Manager or go to AutoZonePro.com

HAND TOOLS

Screwdrivers

19 Piece Screwdriver Set

SKU 1142325 **51⁹⁹**
73775

- Slotted: 3/32" x 1.5", 1/8" x 2.5", 3/16" x 4", 3/16" x 8" (Cabinet Tip), 1/4" x 1.5" (Stubby), 1/4" x 4", 1/4" x 6", 5/16" x 6", 3/8" x 8"
- Phillips: #0 x 1.5", #0 x 2.5", #1 x 3", #2 x 1.5" (Stubby), #2 x 4", #2 x 8", #3 x 6", #4 x 8"
- Offset: 3/16" x #1, 1/4" x #2
- Magnetic Tips Hold Fasteners in Place
- Square Shafts Can Be Used with Wrench for More Torque
- Hexagon Shaped Handles Prevent Roll Off
- Color Coded Fluting Defines Driver Type



GreatNeck



Impact Resistant Acetate Handle
(Fluted for Better Grip)



8 Piece Mechanics Screwdriver Set

SKU 802208 **99⁹⁹**
23999

- EVA Tray with Custom Cut Contrast Soft Foam and Sizes Marked for Easy Identification, Designed to Fit Securely in a Cabinet or Tool Box
- Features a Hard Chrome™ Finish, an Easy-to-Clean Smooth Satin Finish That Won't Show Prints and Keeps Rust Away
- Custom Cut of the Tool is a Hi-Vis Green Making it Visible if a Tool is Missing
- Slotted: 1/4" x 1-1/2", 3/16" x 3", 1/4" x 4", 5/16" x 6" and 3/8" x 8"



OEM TOOLS



20 Piece Screwdriver Set

SKU 1142343 **19⁹⁹**
92080

- Chrome Vanadium Steel Shaft for Strength and Durability
- Precision Ground Sandblasted Tip
- Highest Quality Acetate Handle
- Slotted: 3/32" x 2", 1/8" x 2", 3/16" x 4", 1/4" x 1-1/2", 1/4" x 4", 1/4" x 6"
- Phillips: #00 x 1-1/2", #0 x 2", #1 x 3", #2 x 4", #2 x 6", #2 x 1-1/2"
- Star: T15, T20
- Square: #2
- (1) Offset Screwdriver
- 4 Piece Hook and Pick Set

GreatNeck



Star Screwdrivers

5 Piece Star Screwdriver Set

SKU 1142630 **16⁹⁹**
73721

- Star (T10 x 4", T15 x 4", T20 x 4", T25 x 5", T30 x 6")
- Magnetic Tips Hold Fasteners in Place
- Hexagon Shaped Handles Prevent Roll Off

GreatNeck



Gasket Scraper Set

3 Piece Gasket Scraper Set

SKU 1069069 **24⁹⁹**
26501

- Includes: 3/4", 1" and 1-1/2" Gasket Scrapers

OEM TOOLS



Long Reach Screwdrivers

OEM TOOLS

- High Performance Hex Shaped Shaft for More Torque and Less Flex
- Precision Machined and Sand Blasted Tips That Reduce Cam-Out
- Durable Ergonomic Handles are Made of Hardened Resin

5/16" x 20" Slotted Screwdriver

SKU 1142473 **24⁹⁹**
22555

#2 x 20" Phillips Screwdriver

SKU 1142485 **14⁹⁹**
22574

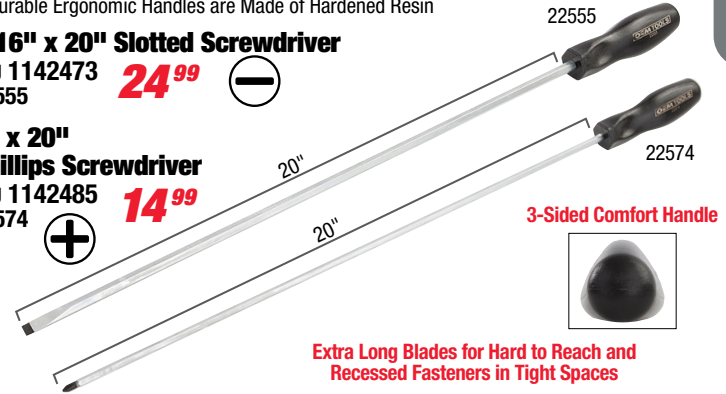

22555

22574

3-Sided Comfort Handle



Extra Long Blades for Hard to Reach and Recessed Fasteners in Tight Spaces

Hex Key Sets

OEM TOOLS

Ball-End Hex Keys Work at Angles Up to 25°



S2
STEEL



Extra Long Reach Hex Key Sets

- Color-Coded for Easy Identification

27 Piece Metric, SAE and Star

SKU 1209375 **74⁹⁹**
24299

- Metric: 1.5 to 10 mm (9 Pc.)
- SAE: 1/16" to 3/8" (9 Pc.)
- Star: T10 to T50 (9 Pc.)

18 Piece Metric and SAE

SKU 479170 **41⁹⁹**
24298

- Metric: 1.5 to 10 mm (9 Pc.)
- SAE: 1/16" to 3/8" (9 Pc.)



Corrosion Resistant Hex Key Sets

- Manganese Phosphate Corrosion Resistance

35 Piece Metric, SAE and Star

SKU 1168819 **39⁹⁹**
24249

- Metric: 1.27 to 10 mm (13 Pc.)
- SAE: 3/64" to 3/8" (13 Pc.)
- Star: T10 to T50 (9 Pc.)

26 Piece Metric and SAE

SKU 1168833 **23⁹⁹**
24248

- Metric: 1.27 to 10 mm (13 Pc.)
- SAE: 5/64" to 3/8" (13 Pc.)



Prices subject to change without notice. Prices do not include applicable taxes, vehicles, tires, rims, installation or optional equipment as shown. Please do not return purchases to the store. For information regarding warranty, repair, or any questions or concerns, call 901-300-4878.

AZG0326

HAND TOOLS

Mechanics Set

64 Piece 1/4" Drive Set (Metric)

SKU 020788 **159⁹⁹**
23997

- Shallow Sockets, 6 Pt: 4 to 15 mm
- Deep Sockets, 6 Pt: 4 to 15 mm
- Drive Wobble Straight Extension
- Bit Extension Bars: 6" and 10"
- Ratchet Screwdriver
- Universal Joint
- Ratchet
- 28 Bits



20" Width x 8" Depth

OEM TOOLS®



Flare Nut Set

10 Piece Flare Nut Socket Set

SKU OSB **79⁹⁹**
24040

- Secure Grip Prevents Rounding of Brake, Fuel, And Hydraulic Line Fittings
- Open-Sided Design Reaches Tight Spaces Without Disconnecting Wiring or Tubing
- Complete Metric Coverage from 10 mm to 19 mm for Modern Vehicle Systems
- Chrome Vanadium Steel with Corrosion-Resistant Finish for Long Service Life



6-15/16" Width x 6-15/16" Depth

OEM TOOLS®

NEW

For OSB, Call 901-300-4878

Universal Joints

1/4" Drive

SKU 081225 **9⁹⁹**
22520



(Style May Vary)

1/2" Drive

SKU 081227 **13⁹⁹**
22522

3/8" Drive

SKU 081226 **10⁹⁹**
22521

OEM TOOLS®

Socket Adapters

3 Piece Low-Profile Adapter Set

SKU 818570 **29⁹⁹**
22535

- CR-V Steel for Strength
- Get into Tighter Spaces
- Includes: 1/4" F x 3/8" M, 3/8" F x 1/2" M, and 1/2" F x 3/4" M



Adapters

- Hard Chrome™ Finish is Easy to Clean and Will Keep Away Rust



22534

HARD CHROME™ FINISH

OEM TOOLS®

SKU	Part #	Drive	Price
081228	22530	1/2" F x 3/4" M	6.99
081229	22531	1/2" F x 3/8" M	6.99
081230	22532	3/8" F x 1/2" M	7.99
081232	22533	3/8" F x 1/4" M	6.99
081233	22534	1/4" F x 3/8" M	7.99

Socket Sets

- Posi-Grip No-Slip®
- Off Corner Loading for Greater Torque
- Knurling Position for Best Finger Gripping

- Chamfered Ends Allow the Socket to Easily Slip Over the Bolt Head
- Deep Marking for Easy Identification



1/4" Drive Socket Sets

10 Piece (SAE)

SKU 127786 **13⁹⁹**
22952

- 3/16" to 9/16"

12 Piece (Metric)

SKU 127836 **21⁹⁹**
22950

- 5 mm to 15 mm

10 Piece Deep (SAE)

SKU 1414402 **26⁹⁹**
22953A

- 3/16" to 9/16"

12 Piece Deep (Metric)

SKU 127772 **31⁹⁹**
22951

- 5 to 15 mm



10 Piece 1/4" Deep (SAE)

SKU 850056 **39⁹⁹**
23985

- Includes: 3/16" to 9/16"

12 Piece 1/4" Deep (Metric)

SKU 850510 **39⁹⁹**
23986

- Includes: 5 mm to 15 mm



10" Width x 4" Depth

OEM TOOLS®



3/8" Drive Socket Sets

11 Piece (SAE)

SKU 127798 **26⁹⁹**
22956

- 1/4" to 7/8"

12 Piece (Metric)

SKU 127794 **35⁹⁹**
22954

- 8 mm to 19 mm

11 Piece Deep (SAE)

SKU 127803 **43⁹⁹**
22957

- 1/4" to 7/8"

12 Piece Deep (Metric)

SKU 127797 **40⁹⁹**
22955

- 8 mm to 19 mm



12 Piece 3/8" Deep Socket Set (Metric)

SKU 103402 **40⁹⁹**
23981

- Includes: 8 mm to 19 mm



10" Width x 7" Depth



1/2" Drive Socket Sets

11 Piece (SAE)

SKU 127812 **46⁹⁹**
22960

- 1/2" to 1-1/8"

10 Piece (Metric)

SKU 127807 **29⁹⁹**
22958

- 10 mm to 19 mm

11 Piece Deep (SAE)

SKU 127846 **64⁹⁹**
22961

- 1/2" to 1-1/8"

10 Piece Deep (Metric)

SKU 127809 **40⁹⁹**
22959

- 10 mm to 19 mm



24 Piece 3/8" Drive Socket Set (Metric)

SKU 127868 **54⁹⁹**
22963

- Includes: 8-19 mm (Deep) and 8-19 mm (Shallow)

22 Piece 3/8" Drive Socket Set (SAE)

SKU 127869 **74⁹⁹**
22962

- Includes: 1/4" to 7/8" (Deep); 1/4" to 7/8" (Shallow)



Prices subject to change without notice. Prices do not include applicable taxes, vehicles, tires, rims, installation or optional equipment as shown. Please do not return purchases to the store. For information regarding warranty, repair, or any questions or concerns, call 901-300-4878.

Ratchets

HARD CHROME™ FINISH **OEM TOOLS®**

- 36 Teeth with 10° Arc Motion for Precision and Strength
- Reversing Lever Allows a Forward and Reverse in One-Hand Action
- Sealed to Keep Dirt and Debris Out of Head
- Compact Head Designed to Get into Tight Spaces

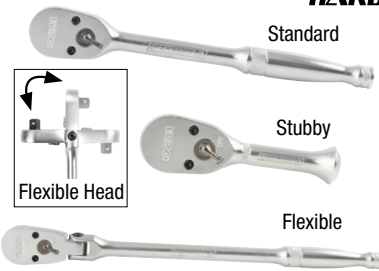

SKU	Part #	Type	Drive	Length	Price
081298	22900	Standard	1/4"	4-1/4"	24.99
177728	22911	Standard	3/8"	8"	29.99
177768	22920	Standard	1/2"	10"	49.99
177702	22910	Stubby	3/8"	4"	27.99
081301	22901	Flexible	1/4"	6"	34.99
177730	22912	Flexible	3/8"	11-1/2"	35.99
177769	22921	Flexible	1/2"	17-1/2"	64.99

Flex Head Breaker Bars

- Special Alloy Steel, Heat-Treated to Provide Durability
- 180° Flex Head Provides Leverage at Desired Angle for Hard-to-Reach Applications

SKU	Part #	Drive	Length	Price
081302	22913	3/8"	11-9/16"	24.99
081303	22922	1/2"	18"	31.99
750437	22923	1/2"	24"	35.99



Extensions

OEM TOOLS®

- Chamfered Ends for Positive Engagement with Drive Tools
- Knurled Shank for Easy Fingertip Turning
- Milled Ends Provide a Solid Connection

SKU	Part #	Drive	Length	Price
081213	22481	1/4"	4"	2.99
081215	22482	1/4"	6"	7.99
081218	22483	1/4"	11"	10.99
081219	22490	3/8"	1-3/4"	5.99
081220	22491	3/8"	4"	8.99
306326	22492	3/8"	6"	5.99
306287	22494	3/8"	10"	7.99
306279	22495	3/8"	18"	11.99
081212	22480	1/2"	2"	4.99
081221	22500	1/2"	3"	10.99
081223	22501	1/2"	6"	9.99
081224	22502	1/2"	10"	11.99

Ratchet and Socket Set

OEM TOOLS®

26 Piece 1/2" Drive Ratchet and Socket Set

SKU 591154 **174.99**
23995

- Includes: (21) 6 Pt. Metric and SAE Sockets
- (1) 1/2" Dr. Extension Bar 3"
- (1) 1/2" Dr. Extension Bar L6
- (1) 1/2" Swivel U-Joint
- (1) 1/2" Dr. Regular Ratchet

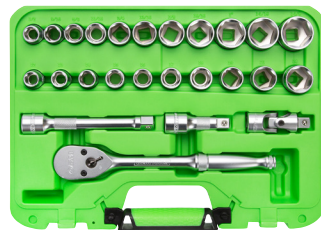

Spiral Drive Set

OEM TOOLS®

5 Piece Spiral Drive Bit Set

SKU 802234 **29.99**
22975

- Sizes: MTS0, MTS1, MTS2, MTS3 and MTS4
- 3/8" Drive
- Services New Fasteners Found on Many GM, Chrysler, BMW and Fiat Vehicles of the Mid-2000 and Later Model Range Including Bolts That Secure the Bell Housing to the Transmission on GM 4L60 Transmissions



Triple Square Bit Sets

- Use on European Vehicles Like BMW, Mercedes, VW, Audi and Porsche
- Heat-Treated Alloy Steel Bits to Reduce Premature Wear
- Reinforced Chrome Vanadium Steel Sockets to Increase Turning Power
- Fully Refined Hard Chrome Plated Finish and Zinc Phosphate Bits Treatment to Prevent Rust and Corrosion
- Meets and Exceeds ANSI Standards

OEM TOOLS®

10 Piece Extra Long XZN Triple Square Spline Bit Socket Set

SKU 1368626 **59.99**
23519

- Sizes Included: M4, M5, M6, M8, M9, M10, M12, (Tamper-Proof) M14, M16, M18
- Socket Length: 3.93"



10 Piece Magnetic Long Triple Square Bit Socket Set

SKU 1313567 **59.99**
23907

- Sizes Included: (1/4" Drive) M4, M5, M6; (3/8" Drive) M8, M9, M10, M12, M14; (1/2" Drive) M16, M18
- Socket Length: 3.93"



9 Piece Triple Square Bit Set

SKU 191052 **29.99**
25953

- 1/4" Drive: M4, M5 and M6 (Length: 37 mm)
- 3/8" Drive: M8, M10 and M12 (Length: 48 mm)
- 1/2" Drive Tamper-Proof: M14, M16 and M18 (Length: 55 mm)



10 Piece Triple Square Bit Socket Set

SKU 1368630 **31.99**
22711

- Sizes Included: M4, M5, M6, M8, M9, M10, M12, (Tamper-Proof) M14, M16, M18
- Comes Enclosed in Blow Mold Case for Easy Identification and Storage



10 Piece Magnetic Triple Square Bit Socket Set

SKU 1368615 **49.99**
23906

- Powerful Magnetic Bits to Prevent the Loss of Nuts, Bolts and Fasteners
- Comes Enclosed in Blow Mold Case for Easy Identification and Storage
- Sizes Included: (1/4" Drive) M4, M5, M6; (3/8" Drive) M8, M9, M10, M12, M14; (1/2" Drive) M16, M18



HAND TOOLS

- Constructed for Professionals with Superior Materials for Increased Torque and Hardness
- Heat-Treated S2 Steel Bits to Reduce Premature Wear

- Reinforced Chrome Vanadium Steel Sockets for Durability and Improved Finish
- Fully Refined Hard Chrome Plated Finish and Zinc Phosphate Bits Treated to Prevent Rust and Corrosion

OEM TOOLS®

Hex Sets

26 Piece Master Hex Bit Set

SKU 802219 **51⁹⁹**
23990

- Includes: 1/4" Drive Sizes: 1/8" to 7/32" and 2.5 to 5 mm, 3/8" Drive Sizes: 1/4" to 11/32" and 6 to 9 mm, 1/2" Drive Sizes: 3/8" to 5/8" and 10 to 19 mm



10" Width x 5" Depth



12 Piece Long (SAE)

SKU 1282747 **55⁹⁹**
23563

- 1/4" Drive: 1/16", 5/64", 3/32", 7/64" and 1/8"
- 3/8" Drive: 9/64", 5/32", 3/16", 7/32", 1/4", 5/16" and 3/8"

12 Piece Long (Metric)

SKU 1282757 **53⁹⁹**
23538

- 1/4" Drive: 2 mm, 2.5 mm, 3 mm, 4 mm and 5 mm
- 3/8" Drive: 5.5 mm, 6 mm, 7 mm, 8 mm, 9 mm, 10 mm and 12 mm

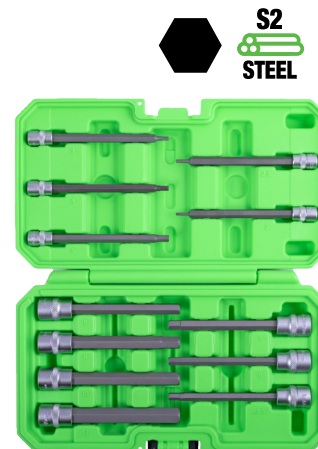

12 Piece Magnetic (SAE)

SKU 1282759 **44⁹⁹**
23900

- 1/4" Drive: 1/16", 5/64", 3/32", 7/64" and 1/8"
- 3/8" Drive: 9/64", 5/32", 3/16", 7/32", 1/4", 5/16" and 3/8"

12 Piece Magnetic (Metric)

SKU 1282804 **43⁹⁹**
23901

- 1/4" Drive: 2 mm, 2.5 mm, 3 mm, 4 mm, 5 mm and 5.5 mm
- 3/8" Drive: 6 mm, 7 mm, 8 mm, 9 mm, 10 mm and 12 mm

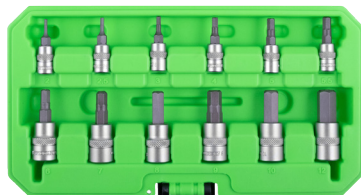

12 Piece Magnetic Long (SAE)

SKU 1282807 **57⁹⁹**
23902

- 1/4" Drive: 1/16", 5/64", 3/32", 7/64", 1/8"
- 3/8" Drive: 9/64", 5/32", 3/16", 7/32", 1/4", 5/16" and 3/8"

12 Piece Magnetic Long (Metric)

SKU 1282737 **56⁹⁹**
23903

- 1/4" Drive: 2 mm, 2.5 mm, 3 mm, 4 mm and 5 mm
- 3/8" Drive: 5.5 mm, 6 mm, 7 mm, 8 mm, 9 mm, 10 mm and 12 mm

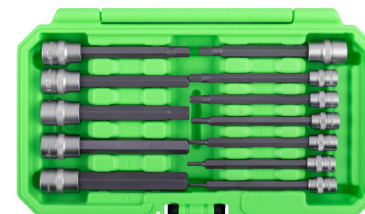

1/2" Drive Hex Bit Set (Metric)

SKU OSB **9⁹⁹**
25417

- Sizes: 12, 14 and 17 mm
- Use on Transmission and Differential Drain Plugs



For OSB,
Call 901-300-4878



1/2" Drive SAE Hex Bit Socket Set (6 Piece)

SKU 1168826 **34⁹⁹**
22999

- Includes 9/16", 5/8", 11/16", 3/4", 13/16" and 7/8"
- Tempered Chrome Vanadium Steel with a Plated Finish for Long Life



1/2" Drive Metric Hex Bit Socket Set (7 Piece)

SKU 1168830 **39⁹⁹**
22998

- Includes: 13, 14, 15, 17, 19, 21 and 22 mm



9 Piece Hex Bit Set (Metric)

SKU 127903 **20⁹⁹**
22983

- Includes: 1/4" Drive 2, 2.5, 3, 4 mm and 3/8" Drive 5, 6, 7, 8, 10 mm
- Knurling Position is Optimized for Best Finger Gripping Position



7 Piece Hex Bit Set (SAE)

SKU 127904 **19⁹⁹**
22982

- 3/8" Drive: 5/16" and 3/8"
- 1/2" Drive: 7/16", 1/2", 9/16", 5/8" and 3/4"



12 Piece Hex Bit Set (SAE)

SKU 127905 **26⁹⁹**
22984

- Includes: (1/4" Drive) 1/16", 5/64", 3/32", 7/64", 1/8"; (3/8" Drive) 9/64", 5/32", 3/16", 7/32", 1/4", 5/16", 3/8"
- Knurling Position is Optimized for Best Finger Gripping Position



Multi-Drive Sets

35 Piece Multi-Drive Star Socket Set

SKU 802217 **67⁹⁹**
23991

- 1/4" Drive Star: T10, T15, T20, T25, T27 and T30
- 1/4" Drive Tamper-Proof Star: T7, T8, T9, T10, T15, T20, T25 and T30
- 1/4" Drive Female Star: E4, E5, E6, E7 and E8
- 3/8" Drive Tamper-Proof Star: T40, T45, T50 and T55
- 3/8" Drive Star: T40, T45, T47, T50 and T55
- 3/8" Drive Female Star: E10, E12, E14 and E16
- 1/2" Drive Star: T60 and T70
- 1/2" Drive Female Star: E18



10-3/4" Width x 5-3/4" Depth



44 Piece Multi-Drive Star and Bit Socket Set

SKU 802206 **57⁹⁹**
23992

- 1/4" Bit Holder
- 1/4" Hex Drive Tamper-Proof Star Bits: T7, T8, T9, T10, T15, T20, T25, T27, T30
- 1/4" Hex Drive Star: T10, T15, T20, T25, T27 and T30
- 3/8" Drive Star: T40, T45, T47, T50, T55 and T60
- 3/8" Drive Metric Hex: 2, 2.5, 3, 4, 5, 6, 7, 8 and 10 mm
- 3/8" Drive SAE Hex: 1/8", 5/32", 3/16", 7/32", 1/4", 5/16" and 3/8"
- 3/8" Drive Phillips: #1, #2 and #3
- 3/8" Drive Slotted: 3/16", 1/4" and 5/16"



10-3/4" Width x 5-3/4" Depth



Star Sets

13 Piece Tamper-Proof Set

SKU 1282735 **29⁹⁹**
22710

- 1/4" Drive: T8, T10, T15, T20, T25, T27 and T30
- 3/8" Drive: T40, T45, T47, T50 and T55
- 1/2" Drive: T60



13 Piece Star Bit Socket Set

SKU 1282806 **27⁹⁹**
22977

- 1/4" Drive: T8, T10, T15, T20, T25, T27 and T30
- 3/8" Drive: T40, T45, T47, T50 and T55
- 1/2" Drive: T60



13 Piece Magnetic Set

SKU 1267957 **46⁹⁹**
23904

- 1/4" Drive: T8, T10, T15, T20, T25, T27 and T30
- 3/8" Drive: T40, T45, T47, T50, T55 and T60

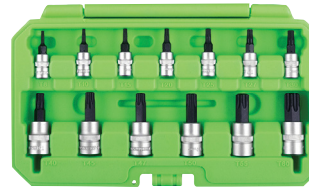

13 Piece Magnetic Long Set

SKU OSB **59⁹⁹**
23905

- 1/4" Drive: T8, T10, T15, T20, T25, T27 and T30
- 3/8" Drive: T40, T45, T47, T50, T55 and T60



For OSB, Call 901-300-4878

13 Piece Extra Long Set

SKU 1282758 **72⁹⁹**
23680

- 1/4" Drive: T8, T10, T15, T20, T25, T27 and T30
- 3/8" Drive: T40, T45, T47, T50, T55 and T60

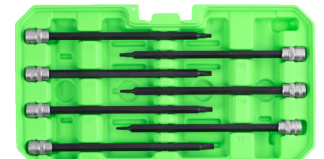

Ratchet Not Included

35 Piece Master Star Bit Set

SKU 466622 **39⁹⁹**
25951 REG. 59.99



- 1/4" Drive Star: T8 to T30
- 1/4" Drive Tamper-Proof Star: T7, T8, T9, T10, T15, T20, T25 and T30
- 1/4" Drive Female Star: E4, E5, E6, E7 and E8
- 3/8" Drive Star: T40, T45, T47, T50 and T55
- 3/8" Drive Tamper-Proof Star: T40, T45, T50 and T55
- 3/8" Drive Female Star: E10, E12, E14 and E16
- 1/2" Drive Star: T60



Offer Good Through September 30, 2026

11 Piece Tamper-Proof Star Set

SKU 127872 **24⁹⁹**
22972

- Includes: (1/4" Drive) T8, T10, T15, T20, T25, (3/8" Drive) T27, T30, T40, T45, T47, T50
- Knurling Position is Optimized for Best Finger Gripping Position
- Black Oxide Finish Indicates Star Drivers
- Chamfered Ends Allow the Socket to Easily Slip Over the Bolt Head
- Comes with Storage Rail



12 Piece Tamper-Proof Star Set

SKU 127870 **24⁹⁹**
22971

- Includes: (1/4" Drive) T8, T10, T15, T20, T25, (3/8" Drive) T27, T30, T40, T45, T47, T50, T55
- Knurling Position is Optimized for Best Finger Gripping Position – Go Ahead and Put On Serious Torque, it Won't Slip
- Black Oxide Finish Indicates Star Drivers
- Chamfered Ends Allow the Socket to Easily Slip Over the Bolt Head
- Comes with Storage Rail



13 Piece Stubby Star Drive Set

SKU 447157 **39⁹⁹**
24293

- Includes Sizes: T7, T8, T9, T10, T15, T20, T25, T27, T30, T40, T45, T47 and T50
- 3/4" Overall Length Designed for Limited Access Applications
- Clearly Etched Sizes for Easy Identification
- Light Aluminum Rail with Adjustable Studs



HAND TOOLS

Pro Series Pliers Sets



3 Piece Groove Joint Pliers Set

SKU 662761 **49⁹⁹**
22648

- Sizes: 8", 10" and 12"
- Gripping Capacity: 8" (1.25"), 10" (1.80"), 12" (2.25")



3 Piece Mechanics Pliers Set

SKU 662748 **44⁹⁹**
22647

- Pliers and Sizes: 7" Diagonal Pliers, 8" Linesman Pliers, 10" Speed-Fit Pliers



Locking Pliers

- For Clamping and Gripping in Tight Spaces
- Constructed with Heat-Treated Alloy Steel
- Precision-Machined Jaws Feature Hardened Teeth to Provide a Sure Grip from Any Angle
- Instant Locking and Release Mechanism for Improved Control
- Nickel Chrome Plated to Resist Rust

7 Piece Locking Pliers Set

SKU 012622 **144⁹⁹**
23987

- Sizes: 4", 5", 7", 10" Curved Jaw and 4", 6", 9" Long Nose



15" Width x 10" Depth 23987

Curved Jaw



22635

Long Nose



22637

Chain



22642

C-Clamp



22641

SKU	Part #	Type	Size	Price
081256	22635	Curved Jaw	4"	12.99
081257	22636		5"	12.99
081261	22638		7"	13.99
081263	22640		10"	19.99
081260	22637	Long Nose	6-1/2"	14.99
081262	22639		9"	15.99
081267	22642	Chain	19"	20.99
081265	22641	C-Clamp	11"	22.99

Extended Reach Pliers



16" Long Reach Long Nose Pliers Set - 3 Piece Set

SKU 1142915 **39⁹⁹**
22660

- Includes: Straight, 45° and 90° Long Nose Pliers
- Features Strong Flush Rivets That Won't Get Caught When Working in Tight Spaces
- Constructed with Heat-Treated Drop-Forged Steel Chrome Plated to Resist Rust and Corrosion
- Double Dipped Handles for Added Comfort and Secure Grip



11" Long Reach Long Nose Pliers



- Constructed with Durable Heat-Treated Alloy Steel
- Precision-Machined Jaws Provide Improved Grip
- TecReady Grip Handles Reduce User Fatigue
- Nickel Chrome Plated to Resist Rust

Straight

SKU 081249 **14⁹⁹**
22621

45°
SKU 081250 **14⁹⁹**
22622

Duck Bill
SKU 213108 **14⁹⁹**
22644



(Color May Vary)

11" Hose Gripper Pliers Set (3 Piece)

SKU 94811 **74⁹⁹**
L311L



- Sizes: 5/16", 1/2" and 3/4" Constructed with Durable Drop Forged Steel
- Specialized Jaw will Securely Grip Cooling System, Fuel and Vacuum Lines without Damaging the Hose
- Heavy Duty Double-Dipped Synthetic Grip Handles to Minimize Slippage and Reduce User Fatigue
- Chrome Plated to Resist Rust



Mechanic's Pliers

- Precision-Machined Jaws Provide Improved Grip
- TecReady Grip Handles Reduce User Fatigue
- Nickel Chrome Plated to Resist Rust



Diagonal Pliers



Groove Joint Pliers



Linesman Pliers



Long Nose Pliers with Side Cutter



SKU	Part #	Type	Size	Color	Price
081240	22614	Diagonal	6-1/2"	Green	25.99
081241	22615	Diagonal	7-1/2"	Red	15.99
081245	22617	Groove Joint	6"	Red	8.99
081246	22618		8"	Red	11.99
081247	22619		10"	Red	16.99
081252	22624		16"	Red	69.99
081243	22616	Linesman	8"	Red	31.99
081237	22612	Long Nose Pliers with Side Cutter	6"	Red	15.99
081239	22613		8"	Red	15.99

X-Type Pliers



2 Piece 13" Long Nose Pliers Set

SKU 213127 **59⁹⁹**
22632

- Includes: 45° and Straight Extended Reach Pliers

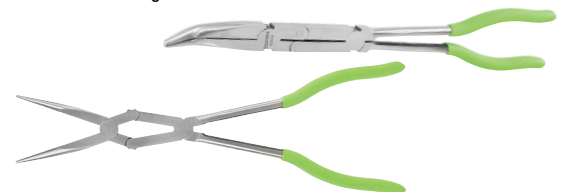

13" Long Nose Pliers

- Serrated Jaws for Precision Gripping

Straight
SKU 213135 **32⁹⁹**
22633

45°
SKU 213117 **32⁹⁹**
22634



HAND TOOLS

TO ORDER, contact your Commercial Sales Manager or go to AutoZonePro.com

HAND TOOLS

Punch Set

OEM TOOLS®

16 Piece Punch and Chisel Set

SKU 914624 25515 **48⁹⁹**

- Includes: 5 Taper Punches, 5 Pin Punches, 2 Center Punches, 3 Cold Chisels and 1 Chisel Gauge



Ball Peen Hammers

GreatNeck

- Hickory Handle Clear Coat Protects Against Rust
- Drop Forged Steel for Strength and Durability
- Steel Wedge Enforced Head for Extra Security



SKU	Part #	Size	Price
1142353	BP12	12"	15.99
536003	BP16	16"	17.99
1142643	BP24	24"	39.99

Pry Bars

OEM TOOLS®

3 Piece Pry Bar Set

SKU 626114 24433 **41⁹⁹**

- Lengths Included: 12", 18" and 24"
- 3 Sided Handle for Secure Grip and Comfort
- Solvent Resistant and Easy to Clean



36" Pry Bar

SKU 695126 24435 **49⁹⁹**

- Unique Ergonomically Designed 3-Sided Handle for Secure Grip and Comfort
- Handles Made with Hardened Resin That is Solvent Resistant and Easy-to-Clean
- Forged and Hardened 5/8 In. Square Stock for Incredible Strength



Dead Blow Hammers

OEM TOOLS®

3 Piece Dead Blow Hammer Set

SKU 900804 25517 **35⁹⁹**

- Soft Rubber Handles for Non-Slip Grip
- Steel Shot Filled for More Force
- Non-Spark Material Used

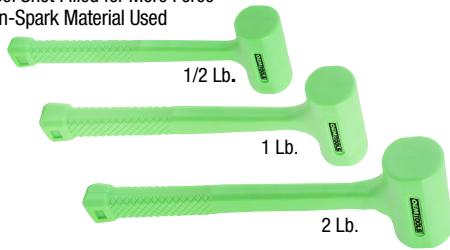

2 Lb. Dead Blow Hammer

SKU OSB 617 **39⁹⁹**

GreatNeck

- Sand-Filled Head, One-Piece Composite Construction for Safety and Durability
- Weight Loaded Material for Extra Hitting Power with Less Bounce
- Will Not Mar Surfaces



Adjustable Wrenches

OEM TOOLS®

- Made with Special Alloy Steel, Heat-Treated
- Deep Marking for Easy Identification
- Nickel Chrome Plated Steel Won't Rust
- Flat Profile is Comfortable in Hands



SKU	Part #	Size	Price
081268	22650	4"	15.99
081269	22651	6"	17.99
081271	22652	8"	19.99
081273	22653	10"	24.99
081274	22654	12"	34.99
081297	22655	15"	59.99

Pipe Wrench

GreatNeck

- Precision Milled Moveable Jaws
- Perfectly Balanced



SKU	Part #	Material	Size	Price
965845	APW14	Aluminum	14"	34.99
965848	APW18		18"	37.99
972768	APW24		24"	49.99
965847	APW36		36"	134.99

Snap Ring Pliers

OEM TOOLS®

6-1/2" Heavy Duty Snap Ring Pliers Set

SKU 15929 25397 **20⁹⁹**

- Tapered Tips: 0.8 mm, 1.2 mm, 1.4 mm and 2.0 mm
- Spring-Loaded Handles
- Settings: Straight, 45° and 90°



Cutting and Scraping Tools

Folding Lock Back® Utility Knife with Blade Dispenser

SKU 1022296 25537 **16⁹⁹**

- Includes: Blade Dispenser with 50 Blades
- Extra-Wide Handle for Increased Comfort and Leverage



OEM TOOLS®

Premium Folding Lock Back® Utility Knife with Sheath

SKU 1142419 12818 **24⁹⁹**

- 3-1/2" Stainless Steel and Hardwood Handle
- Patented Quick-Change Mechanism
- Accepts All Standard Utility Blades
- Includes: 1 Blade and Leather Sheath with Pocket Clip



SHEFFIELD®

4 Piece Plastic Scraper Set

SKU 900802 25513 **10⁹⁹**

- Works Like a Chisel
- Will Not Scratch Paint
- Will Not Cause Sparks
- Can Be Used for Wheel Weight Removal

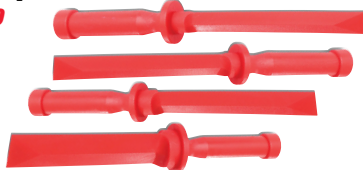

OEM TOOLS®

10" Utility Scissors

SKU 1142911 25085 **13⁹⁹**

- Super Hard Diamond-Like Carbon (DLC) Coating
- Stainless Steel Construction for Strength and Durability
- Bolt Lock Keeps Blades Secure
- Full Length Metal Frame Extends Through Handle for Added Strength



OEM TOOLS®

Scraper Kit

SKU 1282744 69004 **24⁹⁹**

- Includes: 2 Packs of Razor Blades (200) and 1 Razor Blade Scraper
- Perfect for Removing Paint and Decals



OEM TOOLS®

24⁹⁹ REG. \$43.97
SAVE OVER \$18
When You Buy the Kit

Moab Auto Emergency Folding Pocket Knife

SKU 1142700 12870 **20⁹⁹**

- 3-5/16" Partially Serrated Stainless Steel Blade, 4-1/2" Folded
- One-Handed Opening Mechanism
- Liner Lock
- Glass Breaker
- Belt Cutter
- Pocket Clip
- 4.5 Oz.
- Lifetime Warranty



SHEFFIELD®

Prices subject to change without notice. Prices do not include applicable taxes, vehicles, tires, rims, installation or optional equipment as shown. Please do not return purchases to the store. For information regarding warranty, repair, or any questions or concerns, call 901-300-4878.

HAND TOOLS

Precision Drivers

- Precision Driver Sets for Electronics and Applications in Tight Spaces
- Magnetic Tips to Secure Fasteners
- Constructed with Durable Chrome Vanadium Steel

7 Piece Metric Nut Driver Set

SKU 1282732 **26⁹⁹**
22562

- Includes: 3.0, 3.5, 4.0, 4.5, 5, 5.5 and 6.0 mm

7 Piece Metric Hex Driver Set

SKU 1282731 **24⁹⁹**
22563

- Includes: 0.7, 0.9, 1.3, 1.5, 2.0, 2.5 and 3.0 mm



6 Piece Precision Star Screwdriver Set

SKU 003763 **18⁹⁹**
22559

- Constructed with Durable Chrome Vanadium Steel
- Set Includes: T5, T6, T7, T8, T9 and T10



Magnetic Tips to Secure Fasteners

OEM TOOLS

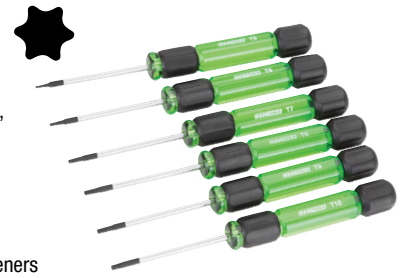

Pick Sets

4 Piece 14" Jumbo Pick Set

SKU 094658
25940

43⁹⁹

- Includes: Straight, 90°, Offset and Hook Pick



8 Piece Combination Hook and Pick Set

SKU 1168660 **24⁹⁹**
68913

- Set Includes: 4 Pc. 8" Hook and Pick Set with Acetate Handle and 4 Pc. 6" Mini Hook and Pick Set with Cushion Grip



6 Piece 8" Hook and Pick Set

SKU 1207883 **20⁹⁹**
26545

- Set Includes: 1 Hook Pick, 1 Complex Pick, (1) 90° Pick, 1 Combination Pick, 1 Double Angle Pick, 1 Straight Pick



8 Piece 10" Cushion Hook and Pick Set

SKU 1207881 **14⁹⁹**
26526

- Set Includes: Hook Pick, 90° Pick, 45° Pick, Double Angle Pick, Complex Pick, Angle Hook Pick, Combination Pick and a Straight Pick



OEM TOOLS

Safety Wire Pliers

Reversible Wire Twister Pliers

Includes: 10 Meter x 0.5 mm Wire

- Heavy Duty Construction with Automatic Spring Return
- Reversible Action for Left and Right Twists
- Locking Jaws for Superior Wire Twisting
- Forged High Carbon Diamond Grooved Jaws to Cut and Grip Stainless Wire

9" SKU 1362002 **79⁹⁹**
22662

6" SKU 1282736 **79⁹⁹**
22661

6" and 9" SKU 1282746 **139⁹⁹**
22663



Hack Saws

Professional Hack Saw

SKU 1142352 **22⁹⁹**
74007

- Includes (1) 12" 24 TPI Bi-Material Blade
- High Tension Blade Prevents Twisting to Ensure Straight, Fast Cut
- Ergonomic Comfort Grip on Front Frame and Handle Provides Two-Handed Control



12" Steel Adjustable Frame Pistol Grip Hacksaw

SKU OSB **30⁹⁹**
50

- Heavy Duty Adjustable Steel Frame Accepts 10" and 12" Blades
- High Impact Pistol Grip Handle
- 4 Cutting Positions and 3" Cutting Depth
- Includes (1) 10" Standard Hacksaw Blade

For OSB, Call 901-300-4878

GreatNeck



Bolt Cutters

8" Mini Bolt Cutter

SKU 479080 **34⁹⁹**
22609

- Chrome Moly Steel Construction and Induction Hardened Cutting Edges
- Designed for Heavy Duty Wire, Bolt, Nail and Rivet Cutting
- Induction Hardened Blades Rated at Over 58 HRC
- Cuts 5.0 mm Diameter Medium Hard Wire, 4.0 mm Diameter Hard Wire and 3.6 mm Piano Wire



OEM TOOLS

GreatNeck

Bolt Cutters

- Forged S2 Steel Construction for Cutting Power
- Hardened Cutting Edge for Long Life
- Ergonomic Comfort Grip Handles
- Limited Lifetime Warranty

18" SKU OSB **34⁹⁹**
BC18

24" SKU 025213 **48⁹⁹**
BC24

36" SKU 965827 **74⁹⁹**
BC36

30" SKU 965828 **84⁹⁹**
BC30

For OSB, Call 901-300-4878



Specialty Wrenches

Adjustable Gland Nut Wrench

- For Hydraulic Cylinders with Gland Nuts
- Reversible Design

SKU 1207900 **17⁹⁹**
27398

- Range: 1" to 3.75"
- Pin Size: 7/32" and 1/4"
- Drive: 1/2"

SKU 1340231 **25⁹⁹**
27397

- Range: 2" to 6"
- Pin Size: 1/4" and 5/16"
- Drive: 3/4"

OEM TOOLS

Nut Drivers

7 Piece Professional Nut Driver Set

- Chrome Vanadium Steel for Strength and Durability
- Highest Quality Acetate Handle Stands Up to Abuse
- Color Coded for Easy Identification

Metric SKU OSB **21⁹⁹**
ND71

- Sizes: 6, 7, 8, 9, 10, 11 and 12 mm

SAE SKU OSB **17⁹⁹**
ND72

- Sizes: 3/16", 1/4", 5/16", 11/32", 3/8", 7/16" and 1/2"



GreatNeck

For OSB, Call 901-300-4878

THREAD REPAIR

TO ORDER, contact your Commercial Sales Manager or go to AutoZonePro.com

THREAD REPAIR

Spiral Bolt Extractor Sets Bites into Rusted, Rounded and Painted Over Nuts and Bolts **OEM TOOLS®**

- Made of High-Quality Chrome Molybdenum Steel for Durability
- Grips and Removes a Wide Range of Stubborn Fasteners
- 3/8" Drive



Specialized Spiral Design for a Secure Universal Grip on Nuts and Bolts

5 Piece Spiral Type Deep Extractor Set on Aluminum Rail

SKU 063893 **44⁹⁹**
22993

- Sizes: 3/8" (10 mm), 7/16" (11 mm), 1/2" (13 mm), 9/16" (14 mm) and 5/8" (16 mm)



5 Piece Spiral Type Extractor Set on Aluminum Rail

SKU 081304 **34⁹⁹**
22985

- Sizes: 5/16" (8 mm), 10 mm, 13 mm, 11/16" and 3/4" (19 mm)



5 Piece Spiral Type Extractor Add-On Set

SKU 081306 **31⁹⁹**
22987

- Sizes: 3/8", 7/16" (11 mm), 1/2", 9/16" (14 mm) and 5/8" (16 mm)



10 Piece Spiral Type Bolt Extractor Set on Aluminum Rail

SKU 081788
22988

- Sizes: 5/16" (8 mm), 3/8", 10 mm, 7/16" (11 mm), 13 mm, 11/16", 1/2" (13 mm), 9/16" (14 mm), 3/4" (19 mm) and 5/8" (16 mm)

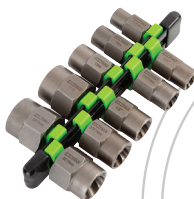

58⁹⁹

REG. \$66.98

SAVE OVER \$7

When You Buy the Set

Nut Busting Bolt Extractors

9 Piece (SAE) Nut Busting Bolt Extractor Socket Set **OEM TOOLS®**

SKU 751720 **42⁹⁹**
22968

- High Visibility Markings for Fast, Easy Socket Selection
- Chrome-Molybdenum Steel Construction for Maximum Durability
- 3/8" Drive
- Includes: 1/4", 5/16", 3/8", 7/16", 1/2", 9/16", 5/8", 11/16" and 3/4"



Specialized Design for a Secure Universal Grip

Axle Spindle Thread Repair **OEM TOOLS®**

OEM TOOLS®

Axle Spindle Threading Set

SKU 1103645 **89⁹⁹**
37233

- Used to Clean or Repair Axle Threads
- Set Comes with a Special Twist Shape That Provides Easier and Quicker Work
- Sizes Included: M20 x 1.25, M20 x 1.50, M22 x 1.00, M22 x 1.50, M24 x 1.50, M24 x 2.00, 13/16" x 20 UNEF, 3/4" x 20 UNEF and 27 mm Extension Bar



Tap Sockets **OEM TOOLS®**

OEM TOOLS®

8 Piece Tap Socket Set

SKU 1544666 **29⁹⁹**
24750

- Designed to Fit All Standard Taps Up to 1/2"
- Compatible with 1/8" NPT Taps and Metric Taps Up to 12 mm
- Perfect for Use in Tight Spaces Where a T-Handle Cannot Fit



Drain Plug Repair

Oil Pan Rethreading Kit

SKU 751709 **164⁹⁹**
LIS58850

- Oil Pan Plug Rethreading Kit Works on Steel or Aluminum Pans 1/2", 12 mm and 14 mm Threads



Lisle

Screw Extractor Bit Sets

6 Piece Spiral Flute Screw Extractor Set

SKU 099277 **11⁹⁹**
24374

- Extractors: Ex-1, Ex-2, Ex-3, Ex-4, Ex-5 and Ex-6
- Comes in a Vinyl Pouch



10 Piece Spiral Extractor and Drill Bit Combo Pack **OEM TOOLS®**

OEM TOOLS®

SKU 099229 **31⁹⁹**
24373

- Extractors: Ex-1, Ex-2, Ex-3, Ex-4 and Ex-5
- Left Hand 135° Split Point Cobalt
- Drill Bit Sizes: 5/64", 7/64", 5/32", 1/4" and 19/64"
- Pilot Point Starts on Contact and Eliminates Bit Walking
- Comes in a Vinyl Pouch

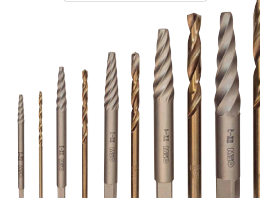

10 Piece Multi-Spline Screw Extractor Set

SKU 099281 **45⁹⁹**
24375

- Sizes 1/8" to 13/32" (1/32" Increments)
- Can Be Used with Hand Sockets and Wrenches
- Aggressive Left Hand Spiral Design Provides Extra Gripping Power
- Designed to Prevent Extractor from Entering too Deeply and Expanding Screw
- Comes in a Foam-Lined Metal Case



35 Piece Master Screw Extractor/Drill Bit Set

SKU 099258 **149⁹⁹**
24377

- Spiral and Multi-Spline Extractors for Removing the Toughest Bolts and Screws from 3/32" to 15/16"
- 135° Split Point Left Hand Cobalt Drill Bits
- Comes in a Plastic Blow Mold Case

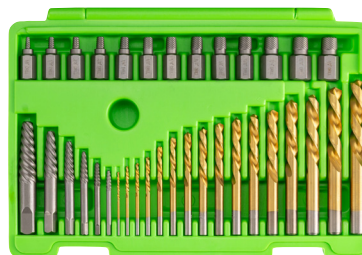

4 Piece Damaged Screw Extractor Set

SKU 081310 **9⁹⁹**
25158

- Used to Quickly Remove Stripped, Broken and Painted Over Screws
- Will Work with Phillips, Flathead, Hex and Other Common Screws



Prices subject to change without notice. Prices do not include applicable taxes, vehicles, tires, rims, installation or optional equipment as shown. Please do not return purchases to the store. For information regarding warranty, repair, or any questions or concerns, call 901-300-4878.

AZG0326

141

SHOP SUPPLIES

Service Center Consumables

Start-Up Kit (Dispenser and Product)

SKU 262544
SNGMFKP994376

684⁹⁹

- Kit Includes:
 - 250 Seat Covers
 - 250 Paper Floor Mats
 - 500 Plastic Floor Mats
 - 500 Parts Bags
 - 100 Tire Bags
 - 1 Metal Floor Rack
 - 1 Sign



Plastic Write On Key Tag (1,000 Count)

- Self Locking Plastic Key Tags Help Secure Keys

29⁹⁹

White

SKU 262547
SNGMFBP993323

Yellow

SKU 1125859
SNGFBP993324

Blue

SKU 1125872
SNGFBP993398

Red

SKU 1125868
SNGFBP993399

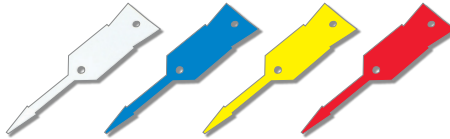

Paper Floor Mat (500/Box)

SKU 1544671
DOWPFM-500

52⁹⁹

- Durable Paper
- Measures 16" x 22"



Disposable Seat Cover

- 2-Layer Construction Keeps Cover in Place
- Refill for Start-Up Kit

Premium (250/Roll)

SKU 262537
SNGMFGP994314

124⁹⁹

- .7 Mil Thick with Dimensions of 32" x 56"

Value (500/Roll)

SKU 186487
SNGMFGP994315

144⁹⁹

- .5 Mil Thick with Dimensions of 32" x 52"



Available in .7 and .5 Mil Thickness



Steering Wheel Cover (500/Box)

SKU 186485
SNGMFBP994333

75⁹⁹

- Double-Band Design Ensures a Snug Fit and Easy Installation



Vehicle Not Included



Plastic Floor Mats (500/Box)

SKU 186488
SNGMFGP994302

79⁹⁹

- Roll Size: 16.5" x 21"
- Comes in Durable Self-Dispensing Box



Parts Bag 11" x 17" (500/Case)

SKU 262541
SNGMFGP994330

50⁹⁹

- High Strength Protection
- Impervious to Most Shop Chemicals



Price Does Not Include Parts Shown



Clear Work Ticket Holder (25/Box)

SKU 698887
SNGFBP993302

74⁹⁹

- 10.5" x 14.5" Clear Front and Back
- Durable Brass Grommet Increases Strength
- Accommodates Most Pre-Printed and Computer Generated Forms



Adhesive Floor Mats (175/Roll)

SKU 262546
SNGMFBP993349

129⁹⁹

- Self Adhesive, 3 mil Protective Film Keeps Carpet Protected

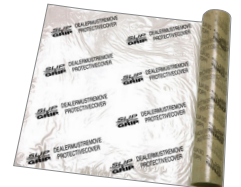

Oil Change Printer and Labels

Thermal Oil Change Sticker Printer Kit

SKU 526488
SNGFKGX00106

699⁹⁹

- Kit Includes: Printer, Keyboard, Power Cord/Adapter, 1 Ink Ribbon and 2 Rolls of 500 Generic Static Cling Labels



Service Reminder Labels

39⁹⁹

- Replacement Roll of 500 Labels



Red Oil Can

SKU 1405960
SNGFB-P993345



Blue Wrench

SKU 1407511
SNGFB-P993394



Hand Cleaner



Starter Kit with Dispenser

SKU 972773
24292

64⁹⁹

- Kit Includes: Wall-Mount Dispenser and 4,000 mL of Cherry Fragrance Cleaner
- All Natural, Concentrated, Solvent Free Cleansing Formula
- Unique Skin Conditioning System Leaves Hands Feeling Smoother, While Fibril Scrubbers Deep Clean Even the Toughest Dirt
- 100% Biodegradable



4000 mL Refill Bottle

SKU 972772
24291

49⁹⁹

Tumbler



20 Oz. Stainless Steel Double Wall Tumbler

18⁹⁹

- Keeps Drinks Cold for 24 Hours and Hot for 6 Hours
- Lid Made from Durable BPA-Free Plastic



Green

SKU 1392320
26046

Black

SKU OSB
26047

For OSB, Call 901-300-4878

Creepers

Workshop Seat and Step Stool

SKU 1189077 **94⁹⁹**
24904

- Combination Step Stool and Creeper Seat That Allows Additional Maneuverability
- Thick Padding Covered with Durable Vinyl Provides Comfort While Working
- Includes a Tool Tray for Organization and Convenience
- 4 Swivel Casters Made for All Terrain
- Weight Capacity: 300 Lb.
- 18"(L) x 16"(W) x 7"(H)



OEM TOOLS®

Sidekick Creeper Seat

SKU 1168662 **139⁹⁹**
24987

- Large Open Tray to Carry a Wide Range of Items with Additional Holster Caddies on the Side for Rapid Access to Most Used Items
- Slide Out Under Seat Drawer Can Be Used to Store and Organize Tools
- Weight Capacity: 330 Lb.



OEM TOOLS®

Heavy Duty Rolling Workbench and Creeper Seat

SKU 1142423 **89⁹⁹**
24986

- Molded Seat and Frame Provide Durable Support
- Removable Clip-In Trays for Storage and Easy Transport of Parts and Tools
- Trays Feature Screwdriver Storage Holes for Easy Organization
- Weight Capacity: 300 Lb.



OEM TOOLS®

Cushioned Creeper Seat with Tool Tray

SKU 757019 **54⁹⁹**
24948

- Tool Tray Dimensions: 11-1/2" x 12-1/2"
- Cushioned Seat
- 4 Swivel, Oil-Resistant Wheels
- Weight Capacity: 330 Lb.



OEM TOOLS®

Mechanics Creepers with Headrest

- Made with HDPE Plastic and Molded for Comfort to Ensure a Quick and Accurate Job
- Easy to Handle, Lift and Store
- 6 Swivel Casters Able to Maneuver All Terrain
- Casters are 3" in Diameter for Additional Durability and Product Longevity
- Weight Capacity: 350 Lb.

36"

SKU 1189084 **46⁹⁹**
24977

- Light Weight 9 Lb.
- 36"(L) x 18"(W)



OEM TOOLS®

40"

SKU 1189063 **89⁹⁹**
24909

- Light Weight 13.2 Lb.
- 40"(L) x 19"(W)

89⁹⁹

Racing Body Board EVA Foam Creeper

SKU 125754 **54⁹⁹**
24972

- Dimensions: 41" x 18" x 1"
- EVA Construction is Water, Chemical and Impact Resistant
- Includes: Handle and (2) Tool Compartment Cut-Outs
- Great for Both Garage and Outdoors
- Lightweight Construction is Portable and Easy to Stow



Tools Not Included

OEM TOOLS®

Professional 41" 6 Wheel Creeper

SKU 125749 **189⁹⁹**
24970

- 3D Streamline Design for Shoulder Clearance
- 6 Heavy Duty TPU Casters Roll Easily and are Resistant to Oil, Grease and Abrasion
- Low Ground Clearance Allows for Greater Mobility and Clearance Under Vehicles
- 4 Tool Storage Trays on Each Side and Next to the Headrest
- Weight Capacity: 300 Lb.



OEM TOOLS®

ProGear Race Seat, Green/Black

SKU OSB **274⁹⁹**
TRX2-705

- Tray Spins for Easy Access to Tools and Parts
- Adjustable Seat Height: 13-1/2" to 17-1/2"
- Five Spoke Frame is OSHA Compliant



For OSB, Call 901-300-4878

TRAXION
engineered products

Topside Creeper

Topside Creeper

SKU 850901 **434⁹⁹**
TRX3-100

- Height Adjusts from 48" to 64"
- Weight Capacity: 400 Lb.



TRAXION
engineered products

Work Stands

Pro Step Adjustable Work Stand

SKU 222856 **334⁹⁹**
STK20350

- 500 Lb. Capacity
- Height Adjustable from 6-1/2" to 22-1/2"
- 32" x 16"



STECK

Truck Tire Step

SKU 818571 **69⁹⁹**
24913B

- Fits Both Front and Rear 9" to 13" Wide Tires
- Powder Coat Finish
- Designed for SUVs, Motor Homes and Light Duty Trucks
- Heavily Textured Non-Slip Step for Safety
- Adjustable Rubber Bumpers Protect Your Wheels and Ensure the Step is Sturdy and Level
- Easy to Adjust
- Weight Capacity: 300 Lb.



OEM TOOLS®

SHOP SUPPLIES

Workshop Stools

Adjustable Hydraulic Shop Stool

SKU 751712
24912

99⁹⁹

- Vinyl Padded Swivel Seat for Comfort
- Chrome Footrest
- Powder Coated Legs



Adjustable Height: 28" to 32-1/2"

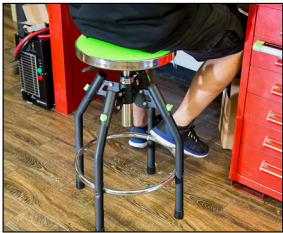

300 Lb. Weight Capacity



360° Rotating Seat

Double Ring Adjustable Stool with Backrest

SKU 1580968
25700

139⁹⁹

- 360° Swivel Seat
- Durable Vinyl Seat and Back Rest Cushion
- Matte Black Finish
- Adjustable Height
- Weight Capacity: 300 Lb.



Adjustable Height



Vinyl Padded, 360° Swivel Seat

Swivel Stool with Double Ring

SKU OSB
25701

89⁹⁹

- Thick 5" Foam Cushion
- 360° Swivel Seat
- Durable Vinyl Seat
- Matte Black Powder-Coated Frame

OEM TOOLS®



Double Ring Design Offers Added Stability and Footrest Support



Double Ring Design



Vinyl Padded, 360° Swivel Seat

For OSB, Call 901-300-4878

Fender Covers

Fender Cover

SKU 965832
24900

28⁹⁹

- Heavy Gauge Vinyl Wipes Clean
- Measures 27" x 34"



OEM TOOLS®

Soft Fleece Fender Cover

SKU 751711
24899

23⁹⁹

- Soft Fleece Fender Cover to Prevent Paint Damage
- 2 Super Powerful Corner Magnets for Securing the Cover in Place
- Magnets are Removable to Wash the Cover
- Large 42" x 24" Size for Cars, Trucks and SUVs



OEM TOOLS®

Magnetic Nut Cups

Multicolor Magnetic Nut Cup Assortment (4 Pack)

SKU 1282743
68939

39⁹⁹

- Holds Bolts, Nuts and Parts to Speed Up Work and Eliminate Misplacing Parts
- Coated Magnet Sticks to All Ferrous Metal Work Surfaces
- Includes: 1 Green Cup, 1 Red Cup, 1 Orange Cup and 1 Blue Cup



OEM TOOLS®



Strong Magnets Attach the Cups Securely to Most Flat Metal Surfaces

Hang Hole



Tools Not Included

Fuse Kits

88 Piece Master Auto Fuse Assortment

SKU 271161
68147

10⁹⁹

- Includes: Mini, ATO, and Maxi Fuses 3A to 100A



96 Piece ATO Fuse Assortment

SKU 271172
68149

8⁹⁹

- Includes: ATO Fuses 3A to 30A



24 Piece Maxi Fuse Assortment

SKU 271152
68146

19⁹⁹

- Includes: Maxi Fuses 20A to 100A



96 Piece Mini Fuse Kit

SKU 271169
68148

19⁹⁹

- Includes: Mini Fuses 3A to 30A



HARDWARE MACHINERY

Hardware and Service Parts

34 Piece Hose Clamp Assortment

SKU 271201 **11⁹⁹**
68137

- Includes Sizes: 5/8" to 1-1/4"



Universal O-Ring Set 419 Piece (Metric)

SKU 546659
68167

24⁹⁹

- Inside Diameters from 3 mm to 50 mm



Universal O-Ring 407 Piece (SAE)

SKU 546661 **19⁹⁹**
68168

- Inside Diameters from 1/8" to 2"

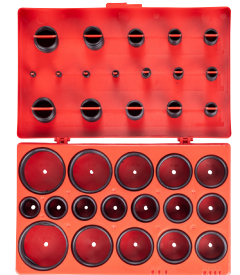

200 Piece Spring Assortment

SKU 271195 **15⁹⁹**
68140

- Includes: 20 Popular Sizes from 7/32" x 11/16" to 5/16" x 1-1/4"



110 Piece Copper Washer Assortment

SKU 271176 **22⁹⁹**
68117

- Includes: Popular Sizes M6 to M16



270 Piece A/C HNBR O-Ring Kit

SKU 271196 **11⁹⁹**
68141

- Contains 270 O-Rings in a Variety of SAE Sizes
- Great O-Ring Set for Most Automotive and Refrigerant Applications

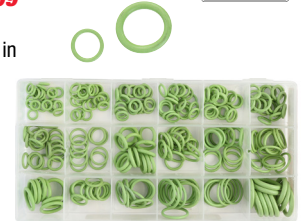

80 Piece Vacuum Cap Assortment

SKU 271197 **31⁹⁹**
68129

- Includes Sizes: 3/16" to 3/8"



555 Piece Stainless Cotter Pin Assortment

SKU 271183 **40⁹⁹**
68121

- Includes: 6 Popular Sizes from 1/16" x 1" to 5/32" x 2-1/2"



115 Piece Master Brake Line Fitting Assortment Kit

SKU 082943 **129⁹⁹**
DOWDY-BLF-5

- 23 Brake Line Fitting Variations
- Tube Nuts, Union, Brake Line Adapters



88 Piece Drain Plug and Gasket Assortment Kit

SKU 617724 **105⁹⁹**
DOWDY-DPA-6

- 18 Drain Plug Variations, 4 Gasket Variations
- Most Popular 12 mm and 14 mm Drain Plugs



240 Piece Master Drain Plug Gasket Assortment Kit

SKU 606762 **134⁹⁹**
DOWDY-DGK-240

- 24 Drain Plug Gasket Variations
- Aluminum, Copper, Crush, Fold-Over, Nylon, Rubber/Metal



120 Piece Oil Drain Plug Gasket Assortment

SKU 1400041 **34⁹⁹**
SURDPG120

- Covers Most Domestic and Import Cars and Light Trucks
- 120 Total
- Includes 24 Variations, 5 Each: Copper, Metal Crush, Nylon, Fiber and Rubber/Metal



76 Piece Oil Drain Plug Assortment

SKU 662839 **89⁹⁹**
SURDP454

- Includes: 76 Pieces with Corresponding Gaskets, 17 Direct Fit SKUs
- Includes: Labeled Case for Quick Identification and Organization
- Covers Most Domestic and Import Cars and Light Duty Trucks



60 Piece Wheel Lug Nut

- 12 Lug Nut Variations

Assortment A

SKU 082947
DOWDY-WN-12

94⁹⁹

- Standard, Dome, Acorn Thread



Assortment B

SKU 082948
DOWDY-WN-12B

149⁹⁹

- Dome Acorn, Bulge, Flat-Capped, External Thread



SAFETY & GLOVES

First Aid Kits

Safeguard Employees and Jobsites Through Injury Preparation with Multi-Functional First Aid Kits

First Aid Kits

- Wall Mountable Organized Durable Plastic Case
- Contains Essentials for Light Injuries and Wounds
- Meets ANSI/ISEA Z308.1-2021, Class A, Type I, II, III, or IV First Aid Kit

25-Person First Aid Kit

SKU 1442584
SAS6025-025 **90⁹⁹**

100-Person First Aid Kit

SKU 765585
SAS6099-100 **164⁹⁹**



SAS6025-025



SAS6099-100



Safety Supplies

Hi Vis Knit Beanie - Orange

SKU 687972
SAS692-1711 **34⁹⁹**

- One Size Fits All
- Comfortable and Warm
- 100% Knit Polyester
- ANSI/ISEA 107 Compliant
- Reflective Knit Stripe



Hot Sleeve

SKU 291321
LIS18700 **24⁹⁹**

- Protects Arms from Burns While Working Around the Engine
- Made of Durable, Heat-Resistant Kevlar
- Double Wall Construction for Added Heat Protection



Face Shield Clear

SKU 972271
SAS5140 **31⁹⁹**

- Impact-Resistant Polycarbonate Shield
- Curved Lens Design
- Ratcheting Headpiece
- Meets ANSI Z87.1-2015



Foam Ear Plugs

SKU 526953
SAS6100 **59⁹⁹**

- Noise Reduction Rating: 31
- 200 Individually Packaged Pairs
- Pre-Shaped Foam Earplugs



Safety Glasses

LED Safety Glasses

SKU 555987
26039 **19⁹⁹**

- High-Impact Resistant Lens Protects Eyes
- Flexible, Lightweight and Padded Frames
- Meets ANSI Z87.1
- Includes: (8) LR41 Batteries

LED Safety Glasses (3 Pack)

SKU 592265
26017PK3 **29⁹⁹**



NSX Turbo Safety Glasses

- High-Impact Polycarbonate Lens
- Safety Eyewear That Also Provides 99.9% UV Protection



Smoke

SKU 462983
SAS5331PK **22⁹⁹**

- Box of 12



Clear

SKU 301767
SAS5330PK **22⁹⁹**

- Box of 12



Amber

SKU 462984
SAS5332PK **22⁹⁹**

- Box of 12

- Scratch-Resistant Coating
- Single Lens Design
- Lightweight Wrap-Around Lens
- ANSI/ISEA Z87.1-2015 Compliant



Multifocal Safety Reading Glasses

- Eye Protection and Multifocal Reading Glasses
- High Impact, Anti-Scratch Lenses Protect Your Eyes
- Fully Adjustable Temples for Comfort and Fit
- ANSI/ISEA Z87.1-2015 Compliant

26⁹⁹
each



+1.5
SKU 752076
26023

+2.0
SKU 752077
26024

+2.5
SKU 752078
26025

+3.0
SKU 752086
26026

Eyewash Stations

Emergency 9 Gallon Eyewash Station Wall Mount Gravity Fed

SKU 912344
SAS5134-00 **299⁹⁹**

- Compliance - ANSI Z358.1-2014
- Portable Unit Measures 20.15" x 16.5" x 9.5"
- Includes: Mounting Bracket, Inspection Tag, Tamper Resistant Tie and Preservative

Eyewash Concentrate Solution

SKU 1142715
SAS5136-01 **28⁹⁹**

- For Use with 9 Gallon Eyewash Station #SAS5134-00



Bottle Eyewash Station

SKU 094904
SAS5132 **129⁹⁹**

- Includes: (2) 16 Oz. Eye Irrigate Solution Bottles
- Does Not Meet ANSI Z358.1

16 Oz. Eyewash Irrigate Refill

SKU 977588
SAS5130 **32⁹⁹**

- For Use with Eyewash Station SAS5132



Detection Light

UV Leak Detection Light and Glasses

SKU 213144
24516 **34⁹⁹**

- Compact UV Leak Detection Pen Light
- Yellow Lens Protective Glasses Enhance Visibility of Leaks
- Can Be Used with All Types of UV Leak Detection Dyes
- Includes: 2 AAA Batteries



2 AAA

SAFETY & GLOVES

TO ORDER, contact your Commercial Sales Manager or go to AutoZonePro.com

SAFETY & GLOVES

Astro-Grip Gloves

ASTRO-GRIP

- 7 mil Powder-Free Exam Grade Nitrile
- Embossed Cube Grip
- Latex-Free



Find In Store,
Right Now
24⁹⁹ per box

Medium SKU 823166 | 66472
Large SKU 823167 | 66473
XL SKU 823168 | 66474
XXL SKU 428345 | 66475



STORE STOCKED

Buy More, Save More



2 Boxes of 100 Each **87⁹⁹** 44.00 per box

Medium SKU 1330679 | SAS66472-2PK

Large SKU 1330676 | SAS66473-2PK

XL SKU 1331500 | SAS66474-2PK

2XL SKU 1331496 | SAS66475-2PK

5 Boxes of 100 Each **213⁹⁹** 42.80 per box

Medium SKU 1330686 | SAS66472-5PK

Large SKU 1331480 | SAS66473-5PK

XL SKU 1331488 | SAS66474-5PK

2XL SKU 1331487 | SAS66475-5PK

10 Boxes of 100 Each **419⁹⁹** 42.00 per box

Medium SKU 1330697 | SAS66472CS

Large SKU 1331497 | SAS66473CS

XL SKU 1331489 | SAS66474CS

2XL SKU 1331494 | SAS66475CS

Raven Gloves

RAVEN

- 7 mil Powder-Free Exam Grade Nitrile
- Ambidextrous Textured Grip
- Latex-Free



Find In Store,
Right Now
19⁹⁹ per box

Medium SKU 435079 | 66517
Large SKU 244622 | 66518
XL SKU 244617 | 66519
XXL SKU 435078 | 66520



STORE STOCKED

Buy More, Save More



2 Boxes of 100 Each **80⁹⁹** 40.50 per box

Medium SKU 547964 | SAS66517-2PK

Large SKU 547965 | SAS66518-2PK

XL SKU 547966 | SAS66519-2PK

2XL SKU 547963 | SAS66520-2PK

5 Boxes of 100 Each **174⁹⁹** 35.00 per box

Medium SKU 1189346 | SAS66517-5PK

Large SKU 1189328 | SAS66518-5PK

XL SKU 1189339 | SAS66519-5PK

2XL SKU 1442587 | SAS66520-5PK

10 Boxes of 100 Each **334⁹⁹** 33.50 per box

Medium SKU 1190191 | SAS66517CS

Large SKU 265052 | SAS66518CS

XL SKU 265053 | SAS66519CS

2XL SKU 1330682 | SAS66520CS

Raven Patriot Gloves

RAVEN PATRIOT

- 7 mil Powder-Free Exam Grade Nitrile
- Textured Fingertips
- Latex-Free



52⁹⁹ per box

Large SKU OSB | SAS66483
XL SKU OSB | SAS66484



Compression Fit Technology



Environmentally Responsible



Supply Chain Resilient

Buy More, Save More

5 Boxes of 100 Each **229⁹⁹** 46.00 per box

Medium SKU 1525554 | SAS66482-5PK

Large SKU 1525556 | SAS66483-5PK

XL SKU 1525565 | SAS66484-5PK

2XL SKU 1525560 | SAS66485-5PK

10 Boxes of 100 Each **450⁹⁹** 45.10 per box

Medium SKU 1522380 | SAS66482CS

Large SKU 1525553 | SAS66483CS

XL SKU 1525561 | SAS66484CS

2XL SKU 1525562 | SAS66485CS



Prices subject to change without notice. Prices do not include applicable taxes, vehicles, tires, rims, installation or optional equipment as shown. Please do not return purchases to the store. For information regarding warranty, repair, or any questions or concerns, call 901-300-4878.

AutoZone®

Tool & Equipment **QUARTERLY**



FREE SHIPPING
WITH MOST ORDERS
SEE PAGE 2 FOR DETAILS

2026
JUL-SEPT

Hablamos Español **Call 901-300-4878**

HIGH-DEMAND SHOP ESSENTIALS

OEM TOOLS®

Professional No-Spill Coolant Funnel Kit

SKU 943142
87043
39⁹⁹



OEM TOOLS®

Multi-Arm Fuel Pump Lock Ring Tool

SKU 1491306
25558
34⁹⁹



OEM TOOLS®

10 Piece Metric Cap Wrench Set

SKU 1189096
87151
39⁹⁹



OEM TOOLS®

R134a Manual Coupler Set

SKU 362980
24396
39⁹⁹



Lisle®

8 Qt. Dispenser Lid and Cap

SKU 80078
LIS19702
34⁹⁹



REDLINE
DETECTION.COM

8 Oz. Smoke Producing Fluid

SKU 802333
RED96-0039
21⁹⁹

