

Please read and save these instructions. Read through this owner's manual carefully before using product. Protect yourself and others by observing all safety information, warnings, and cautions. Failure to comply with instructions could result in personal injury and/or damage to product or property. Please retain instructions for future reference.



OSCILLATING TOOL

FOR CUSTOMER SERVICE

Technical Question?

CALL 1-866-458-2472
customerservice@oem-tools.com

UNPACKING

After unpacking unit, inspect carefully for any damage that may have occurred during transit. Check for loose, missing, or damaged parts. If any damage is observed, a shipping damage claim must be filed with carrier. DO NOT use the OEMTOOLS™ Oscillating Tool if broken, bent, cracked or damaged parts (including labels) are noted. Any Oscillating Tool that appears damaged in any way, operates abnormally or is missing parts should be removed from service immediately. If you suspect that the Oscillating Tool was subjected to shock load (a load that was dropped suddenly, unexpectedly, etc.), immediately discontinue use until it has been checked by a factory authorized service center.



⚠ WARNING

The following safety information is provided as a guideline to help you operate your product under the safest possible conditions. Any tool or piece of equipment can be potentially dangerous to use when safety or safe handling instructions are not known or not followed. The following safety instructions are to provide the user with the information necessary for safe use and operation. Please read and retain these instructions for the continued safe use of your product. Failure to follow instructions listed below may result in serious injury. In addition, make certain that anyone who uses the equipment understands and follows these safety instructions as well.

Explanation of Safety Signal Words

⚠ WARNING: Indicates a potentially hazardous situation which, if not avoided, could result in death or serious injury.

⚠ CAUTION: Indicates a potentially hazardous situation which, if not avoided, may result in minor or moderate injury.

CAUTION: Used without the safety alert symbol indicates a potentially hazardous situation which, if not avoided, may result in property damage.

NOTES: Provide clarity and helpful information.

Thank you very much for choosing an OEMTOOLS™ Product!

For future reference, please register your new tool at www.oem-tools.com and complete the owner's record below:

Model: _____ **Purchase Date:** _____

Save the receipt, warranty and these instructions. It is important that you read the entire manual to become familiar with this product before you begin using it. This product is designed for certain applications only. OEMTOOLS™ cannot be responsible for issues arising from modification. We strongly recommend this product is not modified and/or used for any application other than that for which it was designed. If you have any questions relative to a particular application, DO NOT use the product until you have first contacted customer service to determine if it can or should be performed on the product.

⚠ WARNING: This product can expose you to chemicals, including benzyl violet 4B, which are known to the State of California to cause cancer and birth defects or other reproductive harm. For more information, go to www.P65Warnings.ca.gov.



OSCILLATING TOOL

POWER TOOL SAFETY

⚠ WARNING: Read and understand all safety warnings and instructions. Failure to follow the warnings and instructions may result in electric shock, fire and/or serious injury. Save all warnings and instructions for future reference.

⚠ WARNING

WORK AREA SAFETY

1. Keep work area clean and well lit. Cluttered or dark areas invite accidents.
2. DO NOT operate power tools in explosive atmospheres, such as in the presence of flammable liquids, gases or dust. Power tools create sparks which may ignite the dust or fumes.
3. Keep children and bystanders away while operating a power tool. Distractions can cause you to lose control.

ELECTRICAL SAFETY

1. Power tool plugs must match the outlet. Never modify the plug in any way. DO NOT use any adapter plugs with earthed (grounded) power tools. Unmodified plugs and matching outlets will reduce risk of electric shock.
2. Avoid body contact with earthed or grounded surfaces such as pipes, radiators, ranges and refrigerators. There is an increased risk of electric shock if your body is earthed or grounded.
3. DO NOT expose power tools to rain or wet conditions. Water entering a power tool will increase the risk of electric shock.
4. DO NOT abuse the cord. Never use the cord for carrying, pulling or unplugging the power tool. Keep cord away from heat, oil, sharp edges or moving parts. Damaged or entangled cords increase the risk of electric shock.
5. When operating a power tool outdoors, use an extension cord suitable for outdoor use. Use of a cord suitable for outdoor use reduces the risk of electric shock.
6. If operating a power tool in a damp location is unavoidable, use a residual current device (RCD) protected supply. Use of a ground fault circuit interrupter (GFCI) reduces the risk of electric shock.

PERSONAL SAFETY

1. Stay alert, watch what you are doing and use common sense when operating a power tool. DO NOT use a power tool while you are tired or under the influence of drugs, alcohol or medication. A moment of inattention while operating power tools may result in serious personal injury.
2. Use personal protective equipment. Always wear eye protection. Protective equipment such as dust mask, non-skid safety shoes, hard hat, or hearing protection used for appropriate conditions will reduce personal injuries.
3. Prevent unintentional starting. Ensure the switch is in the OFF position before connecting to power source and/or battery pack, picking up or carrying the tool. Carrying power tools with your finger on the switch or energizing power tools that have the switch on invites accidents.
4. Remove any adjusting key or wrench before turning the power tool ON. A wrench or a key left attached to a rotating part of the power tool may result in personal injury.
5. DO NOT overreach. Keep proper footing and balance at all times. This enables better control of the power tool in unexpected situations.
6. Dress properly. DO NOT wear loose clothing or jewelry. Keep your hair, clothing and gloves away from moving parts. Loose clothes, jewelry or long hair can be caught in moving parts.
7. If devices are provided for the connection of dust extraction and collection facilities, ensure these are connected and properly used. Use of dust collection can reduce dust-related hazards.

POWER TOOL USE AND CARE

1. DO NOT force the power tool. Use the correct power tool for your application. The correct power tool will do the job better and safer at the rate for which it was designed.

2. DO NOT use the power tool if the switch does not turn it ON and OFF. Any power tool that cannot be controlled with the switch is dangerous and must be repaired.
3. Disconnect the plug from the power source and/or the battery pack from the power tool before making any adjustments, changing accessories, or storing power tools. Such preventive safety measures reduce the risk of starting the power tool accidentally.
4. Store idle power tools out of the reach of children and DO NOT allow persons unfamiliar with the power tool or these instructions to operate the power tool. Power tools are dangerous in the hands of untrained users.
5. Maintain power tools. Check for misalignment or binding of moving parts, breakage of parts and any other condition that may affect the power tool's operation. If damaged, have the power tool repaired before use. Many accidents are caused by poorly maintained power tools.
6. Keep cutting tools sharp and clean. Properly maintained cutting tools with sharp cutting edges are less likely to bind and are easier to control.
7. Use the power tool, accessories and tool bits, etc. in accordance with these instructions, taking into account the working conditions and the work to be performed. Use of the power tool for operations different from those intended could result in a hazardous situation.
8. Hold power tool by insulated gripping surfaces, because the blade may contact its own cord. Cutting a "live" wire may make exposed metal parts of the tool "live" shock the operator.
9. Use clamps or another practical way to secure and support the workpiece to a stable platform. Holding the work by hand or against your body leaves it unstable and may lead to loss of control.

SERVICE

Have your power tool serviced by a qualified repair person using only identical replacement parts. This will ensure that the safety of the power tool is maintained.

SPECIFIC SAFETY RULES

⚠ WARNING

1. Know your Oscillating Tool. DO NOT plug the tool into the power source until you have read and understand this Instruction Manual. Learn the tool's applications and limitations, as well as the specific potential hazards related to this tool. Following this rule will reduce the risk of electric shock, fire, or serious injury.
2. ALWAYS wear eye protection. Any power tool can throw foreign objects into your eyes and cause permanent damage. ALWAYS wear safety goggles (not glasses) that comply with ANSI safety standard Z87.1. Everyday glasses have only impact resistant lenses. They ARE NOT safety glasses.
3. Glasses or goggles not in compliance with ANSI Z87.1 could cause serious injury when they break.
4. Always keep hands out of the path of the saw blade. Avoid awkward hand positions where a sudden slip could cause your hand to move into the path of the saw blade.
5. Secure workpiece. Use clamps or a vice to hold the workpiece. It is safer than using your hand and it frees both hands to operate the tool.
6. Make sure there are no nails or foreign objects in the part of the workpiece to be cut or sanded.
7. To avoid injury from accidental starting, always remove the plug from the power source before installing or removing an accessory.
8. Never use dull blades in the tool. They will cut slower, leave rough cuts and break easily due to added pressure and excessive heat. They will also overload the motor and cause premature failure of the tool.
9. Never use damaged or bent blades. They will be brittle and break easily possibly causing injury to the operator.
10. Never touch a saw blade immediately after using the tool. The blade will be extremely hot and will burn your hand.
11. Only use accessories designed for use with this tool.



OSCILLATING TOOL

EXTENSION CORD SAFETY

⚠ WARNING

Keep the extension cord clear of the working area. Position the cord so it will not get caught on the workpiece, tools or any other obstructions while you are working with the power tool.

1. Make sure any extension cord used with this tool is in good condition. When using an extension cord, be sure to use one of heavy enough gauge to carry the current the tool will draw. An undersized cord will cause a drop in line voltage resulting in loss of power and overheating.
2. The table below shows the correct size to use according to cord length and nameplate ampere rating. If in doubt, use the next heavier gauge. The smaller the gauge number, the heavier the cord.
3. Be sure your extension cord is properly wired and in good condition. Always replace a damaged extension cord or have it repaired by a qualified electrician before using it. Protect your extension cord from sharp objects, excessive heat and damp or wet areas.
4. Use a separate electrical circuit for your power tools. This circuit must not be less than 14 gauge wire and should be protected with either a 15 A time delayed fuse or circuit breaker. Before connecting the power tool to the power source, make sure the switch is in the OFF position and the power source is the same as indicated on the nameplate. Running at lower voltage will damage the motor.

MINIMUM GAUGE (AWG) EXTENSION CORDS (120 V use only)					
Amperage rating		Total length			
More than	Not more than	25' (7.5 m)	50' (15 m)	100' (30 m)	150' (45 m)
0	6	18	16	16	14
6	10	18	16	14	12
10	12	16	16	14	12
12	16	14	12	Not Applicable	

IMPORTANT SAFETY INSTRUCTIONS

The warnings, precautions, and instructions discussed in this manual cannot cover all possible conditions and situations that may occur. The operator must understand that common sense and caution are factors which cannot be built into this product, but must be supplied by the operator.

⚠ WARNING

Use only attachments recommended or sold by manufacturer.

1. DO NOT disassemble the Oscillating Tool. Take it to a qualified professional when service or repair is required. Incorrect reassembly may result in electric shock or fire.
2. Wear approved safety eye/face shield, ear defenders and hand protection.

DISPOSAL

At the end of the useful life of the OEMTOOLS™ Oscillating Tool, dispose of the components according to all state, federal and local regulations.

BATTERY DISPOSAL

Exposure to high temperatures can cause the batteries to explode; DO NOT dispose of in a fire. Some countries have regulations concerning battery disposal. Follow all applicable regulations. Return used batteries to a collection location for recycling. Call 800-822-8837 or visit www.call2recycle.org to find a collection location.

PURPOSE

The OEMTOOLS™ Oscillating Tool is used for removing delicate pieces of trim. This tool is designed for many carpentry, electrical, plumbing, tile repair jobs and most general household maintenance.

PRODUCT SPECIFICATIONS

Voltage:	120V, 60Hz
Variable Speed:	11,000 – 20,000 OPM
Power:	2.3 Amp
Oscillating Angle:	3.2 degrees
Overall Length:	14-1/2"
Power Cord Length:	6 Ft.
Weight:	4.1 Lbs.

INSTRUCTIONS

Always wear safety goggles and gloves.

NOTE: The drawings in the assembly and operating section of this manual may differ slightly from the tool you purchased.

All accessories are installed on this Oscillating Tool in a similar manner. For the purposes of describing the accessory installation, the triangular sanding pad and a metal cutting blade have been illustrated.

⚠ WARNING

Always remove the plug from the power source before installing or removing accessories or sandpaper. Failing to remove the plug from the power source may result in the tool accidentally being started and causing serious injury to the operator.

This Oscillating Tool has been designed for use with either open back or closed back accessories. No tools are required to install open back accessories. A 5 mm hex key is required for installing closed back accessories.

INSTALLING OPEN BACK ACCESSORIES

1. Lift the tool less accessory holder release lever (4) up and toward the front of the tool as far as it will go (5). (Figure 1)

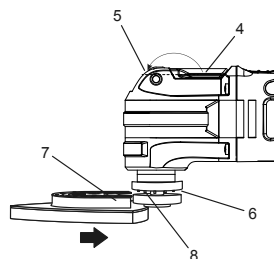

Figure 1

2. Insert the accessory mount (7) into the opened accessory holder.
3. Align the accessory mounting slots and holes with the accessory mounting teeth (8) in the accessory mount.

NOTE: The slots and holes in the accessory must be engaged with the matching teeth on the accessory holder to allow the accessory to be secured within the accessory holder.

4. Move the tool less accessory release lever back to its original position (4) to clamp the accessory into the accessory holder.

NOTE: Check to make sure the accessory mounting pins are still aligned with the slots and holes in the accessory mount.



OSCILLATING TOOL

INSTALLING SANDPAPER

1. Install the hook and loop sanding pad (1) onto the tool. (Figure 2)

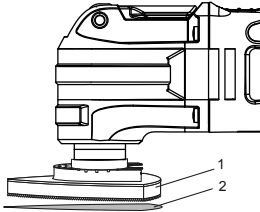

Figure 2

2. Firmly press the sandpaper (2) onto the hook and loop pad.

NOTE: Place the sandpaper so the holes in the sandpaper line up with the matching holes in the hook and loop pad. Press the sandpaper firmly onto the hook and loop pad.

3. To remove the sandpaper, simply peel the sandpaper away from the hook and loop pad. (Figure 3)

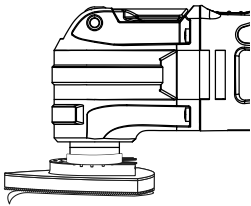

Figure 3

ON/OFF SWITCH

1. To turn the tool ON, slide the ON/OFF switch (1) toward the front of the tool. (Figure 4)

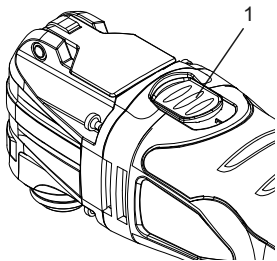

Figure 4

2. To turn the tool OFF, slide the ON/OFF switch toward the rear of the tool.

SPEED CONTROL WHEEL

NOTE: The speed of the tool can be adjusted to run the tool at speeds varying between 11,000 - 20,000 OPM by rotating the speed control wheel (1) located toward the rear of the tool housing. (Figure 5)

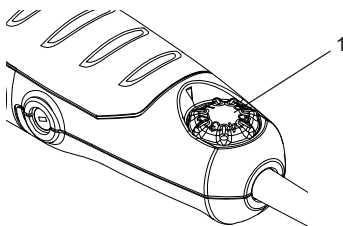

Figure 5

1. To increase the speed, rotate the speed control wheel to the right.
2. To decrease the speed, rotate the speed control wheel to the left.

NOTE: Speed #1 is the lowest speed. "MAX" is the highest speed. The optimal speed setting will vary depending upon the type of accessory being used, the surface being worked and the complexity of the project. For general recommendations, see the chart below.

Project	Accessory	Speed
Balsa Wood	Wood Blade	Low
Drywall	Half-Circle Blade	Maximum
Restoring Windows	Half-Circle Blade	Medium
Door Jamb	Wood Blade	Maximum
Door Casing	Wood Blade	Medium / Maximum
Wood Dowels	Wood Blade	Maximum
Floor Vent	Wood Blade	Medium / Maximum
PVC Pipe	Wood Blade	Medium
Glued Flooring	Scraper	Medium
Sanding	Sander	Medium / Maximum

FLUSH CUTTING A DOOR JAM AND CASING FOR INSTALLING FLOORING

The Oscillating Tool can be used to flush cut a door jamb and casing to allow space for the new flooring to fit neatly under the door jamb and casing. For the purpose of demonstrating the procedure, floor tile is being used.

1. Install the wood plunge cut saw blade in the tool. (Figures 1 and 2)

NOTE: The blade should be centered on the tool housing and NOT installed in the 90° position.

2. Place a scrap piece of floor tile (1) on the floor about 1/2" (12.5 mm) from the door jamb (2). (Figure 6)

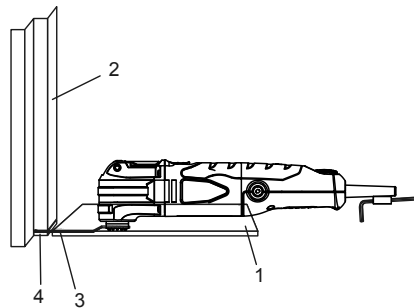

Figure 6

NOTE: Make sure the "good" side of the tile is facing upward to provide a smooth surface for the blade (3) to follow.

3. Place the tool with the saw blade lightly touching the surface of the tile and the cutting teeth NOT touching the surface to be cut.
4. Set the speed to the fastest speed. (Figure 5)
5. Turn the tool ON. (Figure 4)

6. When the tool reaches its maximum set speed, carefully plunge the blade into the door jamb while sliding the blade along the floor tile.

NOTE: Hold the tool tightly and DO NOT put too much forward pressure on the saw blade when cutting, as this will cause the tool to vibrate excessively.

7. Continue to make several plunge cuts until the bottom of the door jamb and casing are completely cut off and the loose pieces (4) can be easily removed.

NOTE: Follow the same basic procedure for installing carpet, using a thicker spacer that is the same thickness of the carpet being installed.



OSCILLATING TOOL

CUTTING A HOLE IN WOOD FLOORING TO INSTALL A HEATING VENT

The Oscillating Tool can be used to cut a hole in wood flooring for installing a heating vent.

1. Install the plunge cutting saw blade for wood in the tool. (Figures 1 and 2)

NOTE: The blade should be centered on the tool housing and NOT installed in the 90° position.

2. Place the floor vent on the floor and use a soft lead pencil to trace the required rectangular hole (1) on the flooring. (Figure 7)

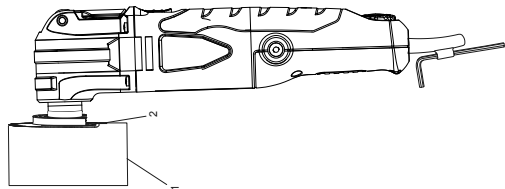

Figure 7

3. Place the saw blade (2) near the floor surface in the middle of one of the cutting lines.
4. Set the tool speed at a medium speed. (Figure 5)
5. Turn the tool ON. (Figure 4)

NOTE: The tool and blade should be at a 45° angle to the floor to allow the corner of the blade to plunge cut into the flooring.

6. While holding the tool tightly, slowly plunge the corner of the blade into the flooring until it cuts through the flooring. Once the plunge cut is complete, set the tool to its highest speed and complete the cut to the corner of the rectangle.
7. Turn the saw OFF, remove it from the cut and proceed to cut in the opposite direction to complete the cut for the first side of the rectangle.
8. Repeat steps #4, #5 & #6 to cut the remaining three sides of the rectangle.
9. When all cuts are complete, use a flat blade screw driver to carefully pry the cut-out from the floor.

NOTE: DO NOT use the saw blade to pry the cut-out from the floor. You will break the blade. If the cut-out is not easy to pry from the floor, check to make sure each line is cut completely into the corner of the rectangle.

CUTTING A HOLE IN DRYWALL FOR INSTALLING AN ELECTRICAL OUTLET BOX

The Oscillating Tool can be used to cut a hole in drywall for installing an electrical outlet box.

1. Install the half-circle saw blade for wood and drywall in the tool. (Figures 1 and 2)

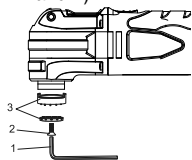

Figure 1

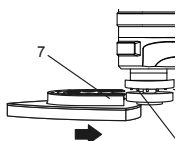

Figure 2

NOTE: The blade should be centered on the tool housing and NOT installed in the 90° position.

2. Place the outlet box on the drywall and use a soft lead pencil to trace the required rectangular hole (1) on the drywall. (Figure 8)

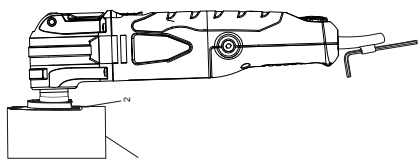

Figure 8

3. Place the corner edge of the saw blade (2) near the drywall in the middle of one of the cutting lines.

4. Set the speed to the highest speed. (Figure 5)

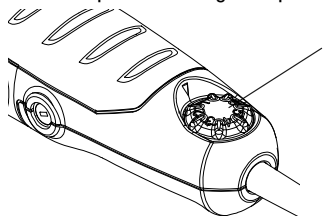

Figure 5

5. Turn the tool ON. (Figure 4)

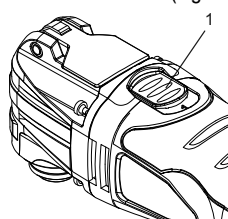

Figure 4

6. When the tool reaches its maximum speed, carefully plunge the blade into the drywall until it cuts through the drywall. Complete the cut to the corner of the rectangle.

NOTE: Hold the tool tightly and DO NOT put too much pressure on the saw blade when cutting.

7. Turn the saw OFF, remove it from the cut and proceed to cut in the opposite direction to complete the cut for the first side of the rectangle.
 8. Repeat steps 4, 5 and 6 to cut the remaining three sides of the rectangle.
 9. When all cuts are complete, use a flat blade screw driver to carefully pry the cut-out from the drywall.
- NOTE:** DO NOT use the saw blade to pry the cut-out from the drywall. You will break the blade. If the cut-out is not easy to pry from the drywall, check to make sure each line is cut completely into the corner of the rectangle.

USING THE SANDER ATTACHMENT

1. Install the sanding pad on the Oscillating Tool. (Figures 1 and 2)
2. Install the sandpaper on the sanding pad. (Figure 3)
3. Set the speed control wheel between #5 and MAX. (Figure 5)
4. Turn the switch ON. (Figure 4)

NOTE: This tool is designed for detail sanding on small surface areas. Place the sandpaper surface of the sanding pad on the workpiece to be sanded. Keep the tool moving to avoid gouging the surface. Use coarse sandpaper and lower speeds when sanding rough surfaces and for removing previous finishes. Use fine sandpaper and higher speeds to produce the smoothest surface.

USING THE SCRAPER BLADE

1. Install the scraper blade on the Oscillating Tool. (Figures 1 and 2)
2. Set the speed control wheel to #4. (Figure 5)
3. Turn the switch ON. (Figure 4)

NOTE: When using the scraper blade to scrape old finishes or glue from a workpiece, place the underside of the blade flat on the workpiece surface and then lift upward on the rear of the tool to allow the blade to form a very slight angle with the workpiece surface. Feed the blade slowly into the material that is to be removed. DO NOT force the tool as slower travel speeds will produce better cutting action and reduce the risk of gouging the workpiece.

NOTE: When using the scraper blade to cut carpet, place a scrap workpiece under the carpet where the cut is being made. Set the speed to #6, turn the tool so the scraper blade is at right angles (perpendicular) to the carpet and then feed the blade into the carpet.



OSCILLATING TOOL

MAINTENANCE

⚠ WARNING

When servicing, use only identical replacement parts. The use of any other part may create a hazard or cause product damage.

DO NOT use solvents when cleaning plastic parts. Plastics are susceptible to damage from various types of commercial solvents and may be damaged by their use. Use a clean cloth to remove dirt, dust, oil, grease, etc.

⚠ WARNING

DO NOT allow brake fluids, gasoline, petroleum-based products, penetrating oils, etc. to come into contact with plastic parts. They contain chemicals that can damage, weaken or destroy plastic.

DO NOT abuse power tools. Abusive practices can damage the tool and the workpiece.

⚠ WARNING

DO NOT attempt to modify tools or create accessories. Any such alteration or modification is misuse and could result in a hazardous condition leading to possible serious injury. It will also void the warranty.

NOTE: It has been found that electric tools are subjected to accelerated wear and possible premature failure when they are used on fiberglass boats and sports cars, wallboard, spackling compounds or plaster. The chips and grindings from these materials are highly abrasive to electric tool parts such as bearings, brushes, commutators, etc. Consequently, it is not recommended that this tool be used for extended work on any fiberglass material, wallboard, spackling compounds or plaster. During any use on these materials, it is extremely important that the tool is cleaned frequently by blowing it out with an air jet.

LUBRICATION

All of the bearings in this tool are lubricated with a sufficient amount of high-grade lubricant for the life of the unit under normal conditions. Therefore, no further lubrication is required.

REPLACING THE CARBON MOTOR BRUSHES

The carbon motor brushes will wear down and require replacing. The time intervals between replacements will vary depending upon the torques being achieved and the hours of use. It is recommended that the brushes be checked after each 10 hours of use. When the length of the carbon brush reaches 1/4" (6.35 mm), the brushes should be replaced.

⚠ WARNING

Make sure the Oscillating Tool is unplugged from the power source.

REMOVING WORN MOTOR BRUSHES

1. Remove any accessory that has been installed on the tool.
2. Lay the tool on its left side on a towel or on corrugated. (Figure 9)

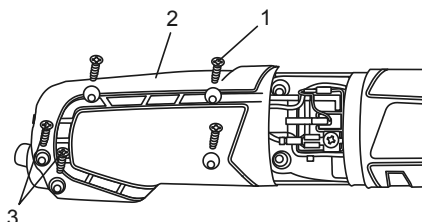

Figure 9

3. Remove 5 screws (1) from the right hand side of the handle (2) using a #2 screwdriver.

NOTE: The two screws (3) at the rear of the handle are shorter than the other three. These must be replaced in the same position when replacing the handle screws.

4. Carefully lift off the right hand half of the handle.

NOTE: Make sure you note the positioning of the speed control wheel and all the wires. They must be placed in exactly the same position when reassembling the handle.

5. Use a small slot screwdriver to lift the end of the coil spring (4) upward and place it on top of the spade connector (5) (Fig. 10).

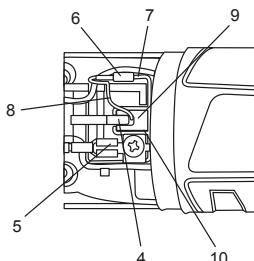

Figure 10

6. Use small needle nose pliers to pull the braided wire spade connector (6) from the spade terminal (7).
7. Carefully grasp the braided copper brush wire (8) and lift the carbon brush (9) from the brush holder (10).

INSTALLING NEW MOTOR BRUSHES

8. Once the old carbon brush has been removed, use a SOFT DRY brush to carefully remove all cutting dust from the brush holder and install the new carbon brush in the reverse order that was used to remove the worn carbon brush.

9. Re-install the new carbon brush in reverse order of paragraphs 5, 6 and 7.

NOTE: Make sure the braided brush wire is routed EXACTLY the same as the original. Make sure the end of the coil spring is placed on top of the carbon brush. (Figure 12)

10. Replace the right hand half of the handle.

NOTE: Make sure the speed control wheel and all wires are placed in exactly the same position as they were when the right hand handle was removed. DO NOT replace the handle screws until the second motor brush has been replaced.

11. Grasp the re-assembled handle and turn the tool onto its right side and remove the left half of the handle.
12. Remove and replace the second carbon motor brush using the same procedures noted above.
13. Once the second motor brush has been replaced, reposition the left half of the handle, making sure the speed control wheel and all wires are placed in exactly the same position as they were when the left half of the handle was removed.

14. Replace the left half of the handle, making sure it fits properly and that all six screws are fully tightened in place.

NOTE: Make sure the two shorter screws are installed in the rear of the handle where the power cord enters the handle.

⚠ ELECTRICAL WARNING

POWER SOURCE CONNECTION POWER REQUIREMENTS

This product is designed to operate on a properly grounded 120 volt, 60Hz, single-phase alternating current (AC) power source fused with a time delayed fuse or circuit breaker. It is recommended that a qualified electrician verify the ACTUAL VOLTAGE at the receptacle into which the product will be plugged and confirm that the receptacle is properly fused and grounded.

DO NOT OPERATE THIS PRODUCT if the ACTUAL power source voltage is less than 105 Volts AC or greater than 132 Volts AC. Contact a qualified electrician if this problem exists. Improper performance and/or damage to the product will result if operated on inadequate or excessive power.

DO NOT abuse cord. Never use the cord to carry tools or pull the plug from an outlet. Keep cord away from heat, sharp edges or moving parts. Replace damaged cords immediately. Damaged cords increase the risk of electric shock.



OSCILLATING TOOL

PARTS DIAGRAM

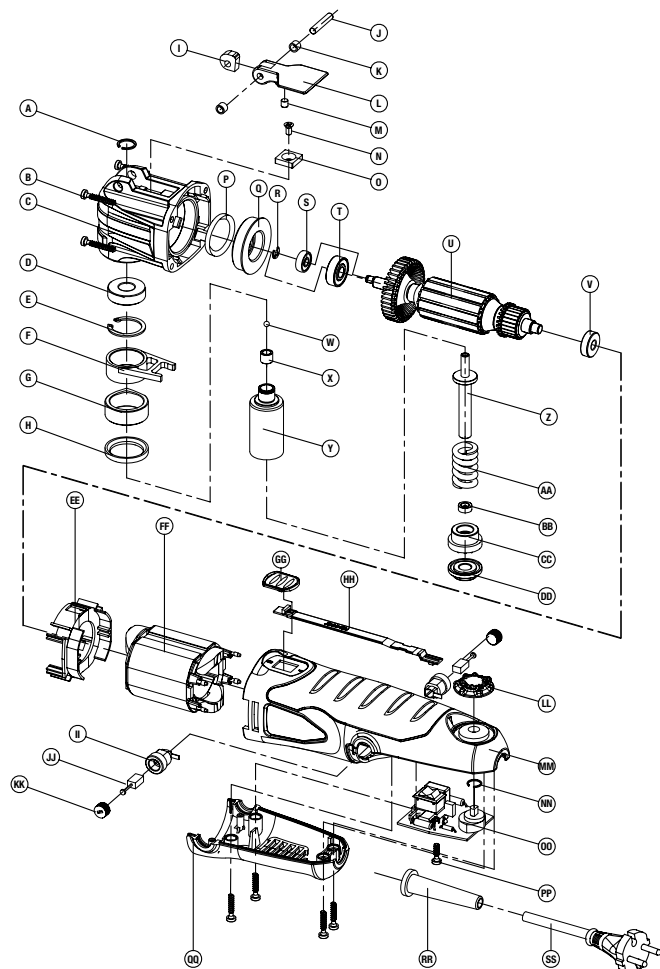

PARTS LIST

Figure	Description	Qty.
A	Shaft Ring	1
B	Screw	8
C	Gear Housing	1
D	Ball Bearing	1
E	Snap Ring	1
F	Fork	1
G	Needle Bearing	1
H	Oil Seal	1
I	Block	1
J	Pin	1
K	Bushing	2
L	Speed Trigger	1
M	Magnet	1
N	Screw	1
O	Square Washer	1
P	Ring	1
Q	Bearing Support	1
R	E-Ring	1
S	Ball Bearing	1
T	Ball Bearing	1
U	Rotor	1
V	Balling Bearing	1
W	Ball	1
X	Bearing	1
Y	Output Shaft	1
Z	Spring Shaft	1
AA	Spring	1
BB	Bearing	1
CC	Connecting Block	1
DD	Press Plate	1
EE	Baffle	1
FF	Stator	1
GG	On/Off Button	1
HH	Switch Lever	1
II	Brush Holder Support	2
JJ	Carbon Brush Assembly	2
KK	Brush Cap	2
LL	Speed Control Knob	1
MM	Motor Housing	1
NN	Shaft Ring	1
OO	PC Board	1
PP	Screw	1
QQ	Handle Cover	1
RR	Cord Guard	1
SS	Power Cord	1

NOTE: Not all components of the product are replacement items but are illustrated as a convenient reference for location and position in the assembly sequence.

OEMTOOLS™ and/or its distributors have provided the parts list and assembly diagram as a reference only. Neither OEMTOOLS™ nor its distributors make any representation or warranty of any kind to the buyer and/or user of this tool that he or she is qualified to do any repairs or replace any parts of this product. OEMTOOLS™ and its distributors expressly state that all repairs or parts replacement should be done by certified or licensed technicians. The buyer assumes all risk and liability arising out of his or her repairs or parts replacement to the original production.



Intertek 3151837 JD2545K This symbol designates that this tool is listed with U.S. requirements by ETL Testing Laboratories, Inc. Conforms to UL Std. 60745-1 and 60745-2-2.





OSCILLATING TOOL

OEMTOOLS™ ONE YEAR WARRANTY

For up to one year from the date of purchase of this OEMTOOLS™ product, if you find any defect in material or workmanship (through normal usage), return it to the place of purchase or to OEMTOOLS™ for repair or replacement at our discretion. In order to obtain this service, send the product and proof of purchase (transportation pre-paid) to:

OEMTOOLS™ Q.A. Dept, 3580 E. Raines Road #3, Memphis, TN 38118.

We will not be responsible for lost or damaged goods during transportation; please insure your package. If our inspection verifies the defect, we will either repair or replace the product, or we may elect to refund the purchase price if we cannot readily and quickly provide you with a replacement. We will return repaired products at our expense, but if we determine there is no defect, or that the defect resulted from causes not within the scope of our warranty, then you must bear the cost of returning the product.

OEMTOOLS™ does not provide warranty for products labeled other than OEM® or OEMTOOLS™. OEMTOOLS™ will not provide any warranty for products subjected to abnormal use. Abnormal use includes (but is not limited to) abuse, accident, alteration, neglect, and unauthorized or unreasonable use or repairs. This warranty does not cover bits, blades, files, batteries, or calibration. We recommend that you maintain your tools and sharpen or replace blades, bits, files, and batteries as necessary. OEMTOOLS™ reserves the right to make any changes in construction or design at any time without any obligation in incorporating such changes to tools or equipment previously sold.

OEMTOOLS™ makes every effort to ensure that its products meet high quality and durability standards, and warrants to the original purchaser that this product is free from defects in materials and workmanship for the period of one year from the date of purchase. This warranty does not apply to damage due directly or indirectly to misuse, abuse, negligence or accidents, repairs or alterations outside our facilities, criminal activity, improper installation, normal wear and tear, or to lack of maintenance.

We shall in no event be liable for death, injuries to persons or property, or for incidental, contingent, special or consequential damages arising from the use of our product. Some states do not allow the exclusion or limitation of incidental or consequential damages, so the above limitation of exclusion may not apply to you. THIS WARRANTY IS EXPRESSLY IN LIEU OF ALL OTHER WARRANTIES, EXPRESS OR IMPLIED, INCLUDING THE WARRANTIES OF MERCHANTABILITY AND FITNESS. This warranty gives you specific legal rights, and you may also have other rights, which vary from state to state.

Don't forget to register your new OEMTOOLS™ product at www.oem-tools.com.

CONTACT US

3580 E. Raines Road, Suite 3, Memphis, TN 38118
Tel: 1-866-458-2472
www.oem-tools.com